



CATALOG & APPLICATION GUIDES



**INTENTIONALLY LEFT BLANK
FOR TWO-PAGE VIEWING**

EVERYTHING YOU NEED

TO ENJOY THE ROAD AHEAD

 **CURT**
curtmfg.com

 **RANCH
HAND**
ranchhand.com

 **ARIES**
ariesautomotive.com

LUVERNE
luvernetruck.com

 **UWS**
uwsta.com

RETRAC
retracmirrors.com



 **LIPPERT**

Lippert is a leading, global manufacturer and supplier of highly engineered products and customized solutions dedicated to shaping, growing and bettering the RV, marine, automotive, commercial vehicle and building products industries. We combine our strategic manufacturing capabilities with the power of our winning team culture to deliver unrivaled customer service, award-winning innovation and premium products to every industry and person we serve.



OUR VISION: TO BE A FORCE FOR GOOD IN THE WORLD

Since 2016, Lippert has focused on designing a cultural foundation from which our success is based, and it stems from one simple driving force: At Lippert, Everyone Matters. From the shop floor to the C-suite, we simply care about people. Our culture is grounded in our five core values that we practice in our business every day.

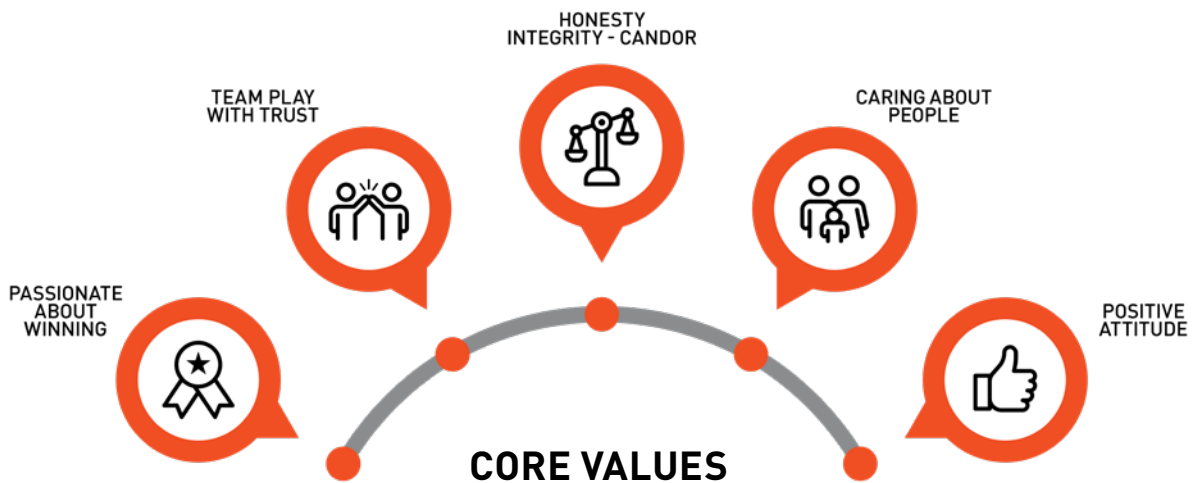

OVER EIGHT YEARS OF IMPACT



2,000+
non-profits served



950,000+
volunteer hours



\$2,000,000+
annually donated to charity

NEW PRODUCTS



Custom-Fit Trailer Hitches

Hitches are at the heart of our new product efforts. We offer many first-to-market designs, in-house testing and an industry-leading finish. **Page 16**



Custom Wiring

We continue to advance our plug-and-play wiring line with new technology, like potted housings and many first-to-market applications. **Page 156**



Gooseneck Coupler

Compatible with most round-tube trailer tongues, our gooseneck coupler features a 2-5/16" ball socket rated for 30,000 lbs. GTWR. **Page 269**



TruTrack™ 2P Trunnion Bar WD

Our innovative design combines precise weight distribution with passive sway control to deliver a smoother, safer ride. **Page 193**



Seeker™ Tow Bar

The Seeker™ makes connecting your vehicle to your RV as simple as possible thanks to its innovative, hands-free locking sleeve. **Page 238**



Fuse Bypass Switches

Designed to integrate with your CURT RV harness, these fuse bypass switches help you avoid the hassle of removing and replacing fuses **Page 245**



Hand-Crank Brake Winches

Our hand-crank brake winches are made from high-quality, cold-forged steel and feature weight capacities up to 2,500 lbs. **Page 290**



Hand-Crank 2-Speed Winches

Designed specifically for pulling applications, our 2-speed hand-crank winches are perfect for winching boats that are 20' or longer out of the water. **Page 289**



Winch Cables & Straps

Our premium winch cables and straps are made from no-stretch polyester web or steel cable wire to give you a smooth, no-hassle winching experience. **Page 288**



Helux™ 5th Wheel Pin Box

Helux™ is an innovative pin box design that absorbs chucking, jerking, jarring, and vibrations for top-of-the-line user comfort and towing control. **Page 228**



AlumaLite™ Adjustable Ball Mounts

AlumaLite™ aluminum drop hitches combine strength with weight savings to make towing and leveling a trailer easier than ever. **Page 108**



Anti-Rattle Hitch Clamp

Our anti-rattle hitch clamp stops rattling, vibration, and noise to ensure a quieter ride when towing your trailer. **Page 125**



Trailer Cable Wire Spools

Engineered for dependable performance, our trailer wire spools are perfect for both trailer rewiring and automotive electrical repairs. **Page 183**



OEM Dual-Output Connector Kit

Quickly and easily plugs into any USCAR socket to provide 4- and 7-way trailer wiring connectors. **Page 158**



4-Way Flat Magnetic Connector

Plug-and-play design quickly converts your existing 4-way flat into a magnetic quick-snap connection for reliable towing. **Page 169**



Steel Roof Rack

Quick and easy to install, our steel roof racks provide a simple yet effective solution for adding additional storage space to your vehicle. **Page 326**

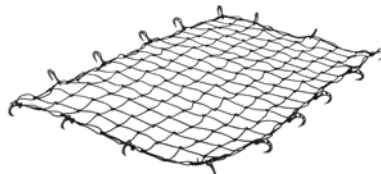

Cargo Nets

Combines the convenience of a bungee cord with the effectiveness of a rope to keep your cargo safe and secure throughout your trip. **Page 328**



Pakka™ Cargo Caddie

Transforms your trunk into a functional, organized space for securing groceries, sports equipment, and more. **Page 327**

PREMIUM AXLE PARTS RETAIL PROGRAM

Lippert is your ultimate one-stop shop for axle parts and components. Our comprehensive offering features premium replacement parts meticulously crafted to meet the highest standards of quality and reliability. Whether you need bearings, hubs, brakes, or any other vital component, we offer exceptional performance and durability. These parts are readily available through Lippert, CURT, or one of our many distribution partners across the country.

See pages 306 and 307 for a select listing of retail packaged part numbers.

Contact your sales representative for more details on our full line of axle products.

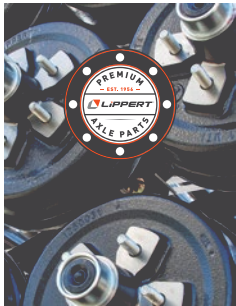

Scan for a digital copy of our full line Axle Parts Catalog

Receive an in-store marketing package with your first qualifying purchase of premium Lippert retail packaged parts!



Header Card (4' or 8')

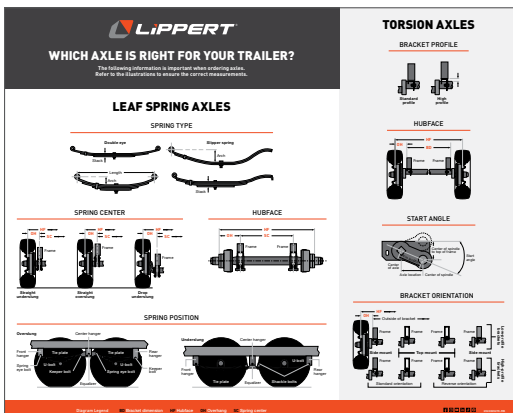

Counter Mat (20" x 16")



Metal Sign (29-1/2")

**GETTING YOU
BACK ON THE
ROAD AGAIN**



PREMIUM AXLE PARTS RETAIL PROGRAM

NEW



BRAKE ASSEMBLIES

Retail Box #	Brake Size	Vehicle Side	Axle Capacity	Adjust.
297956	10" x 2-1/4"	Driver	3,500 lbs.	Manual
298274	10" x 2-1/4"	Passenger	3,500 lbs.	Manual
296649	10" x 2-1/4"	Driver	3,500 lbs.	Self
296650	10" x 2-1/4"	Passenger	3,500 lbs.	Self
298275	12" x 2"	Driver	4,000 - 8,000 lbs.	Manual
298276	12" x 2"	Passenger	4,000 - 8,000 lbs.	Manual
296651	12" x 2"	Driver	4,000 - 8,000 lbs.	Self
296652	12" x 2"	Passenger	4,000 - 8,000 lbs.	Self

BRAKE & IDLER HUB KITS

Retail Kit #	Axle Capacity	Brake Hub Size	Bolt Pattern	Stud Size
Brake Hubs				
2024013264	3,500 lbs.	10"	5 on 4-1/2"	1/2"
2024013262	6,000 lbs.	12"	6 on 5-1/2"	1/2"
2024013260	7,000 lbs.	12"	8 on 6-1/2"	1/2"
2024013261	7,000 lbs.	12"	8 on 6-1/2"	9/16"
Idler Hubs				
2024013263	3,500 lbs.	--	5 on 4-1/2"	1/2"
2024044866	3,500 lbs.	--	5 on 5"	1/2"

Includes bearing kit (installed) and greased, lubed dust cap, cotter pin, castle nut, washer, lug nuts; in a full color retail box



2023134018

2023134654



2023134658

2023134661

2023134012

GREASE & OIL SEALS

Retail Clamshell #	Axle Capacity	Spindle Shaft Diameter
Grease Seals		
2023134653	2,200 lbs.	1.5"
2023134654	3,500 lbs.	1.719"
2023134655	5,200 - 8,000 lbs.	2.25"
Oil Seals		
2023134018	5,200 - 8,000 lbs.	2.250"
2023134019	10,000 lbs.	2.875"
2023134020	12,000 - 16,000 lbs.	3.125"

STANDARD DUST CAPS

Non Lubed Clamshell #	Lubed Clamshell #	Axle Capacity	Bore Size
Dust Caps			
2023134658	2023134661	2,000 - 3,500 lbs.	2"
2023134659	2023134662	5,200 - 6,000 lbs.	2-1/2"
2023134660	2023134011	7,000 - 8,000 lbs.	2-3/4"
Retail Clamshell #	For Use With		
Dust Cap Rubber Plug			
2023134012	Standard lubed dust caps		



2023133979



2023133984

BEARING KITS

Retail Package Kit #	Axle Capacity
Clamshell	
2023133979	2,000 lbs.
2023133980	3,500 lbs.
2023133981	5,200 lbs.
2023133982	6,000 lbs.
2023133983	7,000 lbs.

Retail Package Kit #	Axle Capacity
Retail Box	
2023133984	8,000 lbs.
2023133985	10,000 lbs.
2023133986	12,000 - 16,000 lbs.



2023134021



2024039634



2023134013

SPINDLE & LUG NUT KITS

Retail Clamshell #	Axle Capacity	Washers Included
Spindle Nut Kits		
2023134656	2,000 - 8,000 lbs.	1" round
2023134657	2,000 - 8,000 lbs.	1" D-flat / 1" locking tang
2023134021	10,000 lbs.	1-1/2" round
2023134022	12,000 - 16,000 lbs.	1-7/8" round
Retail Clamshell #	Type	Thread End
Lug Nut Kits		
2024039632	60° cone wheel	1/2"-20
2024039633	60° cone wheel	9/16"-18
2024039634	Hex flange	5/8"-18
2024039635	Swiveling flange	5/8"-18

WHEEL STUDS

Retail Clamshell #	Shoulder Length	Thread End
2023134013	2"	1/2"-20
2023134014	2-5/16"	9/16"-18

BY **LIPPERT**

Download the new
OneControl[®] Auto app!

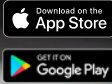

Scan to
learn more

EASILY MANAGE YOUR TRAILER FROM YOUR SMARTPHONE

Boost awareness and control during towing with unparalleled connectivity and comfort. With CURT OneControl[®] Auto, transform your truck and trailer into a smart, interconnected rig, easily monitored via smartphone or tablet. Our innovative towing line employs advanced technologies, enhancing comfort, awareness, and safety on the open road.



Echo[®] Series



True Course[™]



Tire Linc[®] Auto

UNDERSTANDING TOWING

Towing basics and electrical guides

10 - 13

TRAILER HITCHES

Rear and front mount, multi-fit and RV hitches

14 - 33

APPLICATION GUIDE

Hitch and wiring applications listed by make and model

34 - 83

TOWING ACCESSORIES

Ball mounts, trailer balls, locks, pintles and more

84 - 139

TOWING ELECTRICAL

Brake controllers, custom wiring, adapters and connectors

140 - 185

WEIGHT DISTRIBUTION

TruTrack™ systems, WD hitch kits and sway control

186 - 199

5TH WHEEL HITCHES

OEM puck system options, sliders and hitches up to 30K

200 - 235

FLAT TOWING

Tow bars, base plates, wiring and accessories

236 - 249

GOOSENECK HITCHES

OEM puck system kits, OEM-style, Double Lock EZr™ and more

250 - 273

TRAILER PARTS & ACCESSORIES

Jacks, couplers, lunette rings, safety chains, axle parts and more

274 - 307

CARGO MANAGEMENT

Cargo carriers, bike racks, cargo straps and tie-downs

308 - 335

MARKETING SUPPORT

Literature, signage and display stands

336 - 337

NUMERICAL TRAILER HITCHES

Numerical listing of front and rear mount trailer hitches

338 - 348

NUMERICAL PRODUCTS

Complete, numerically sorted product listing

349 - 353

NUMERICAL CUSTOM WIRING

Custom wiring listed numerically

354 - 359

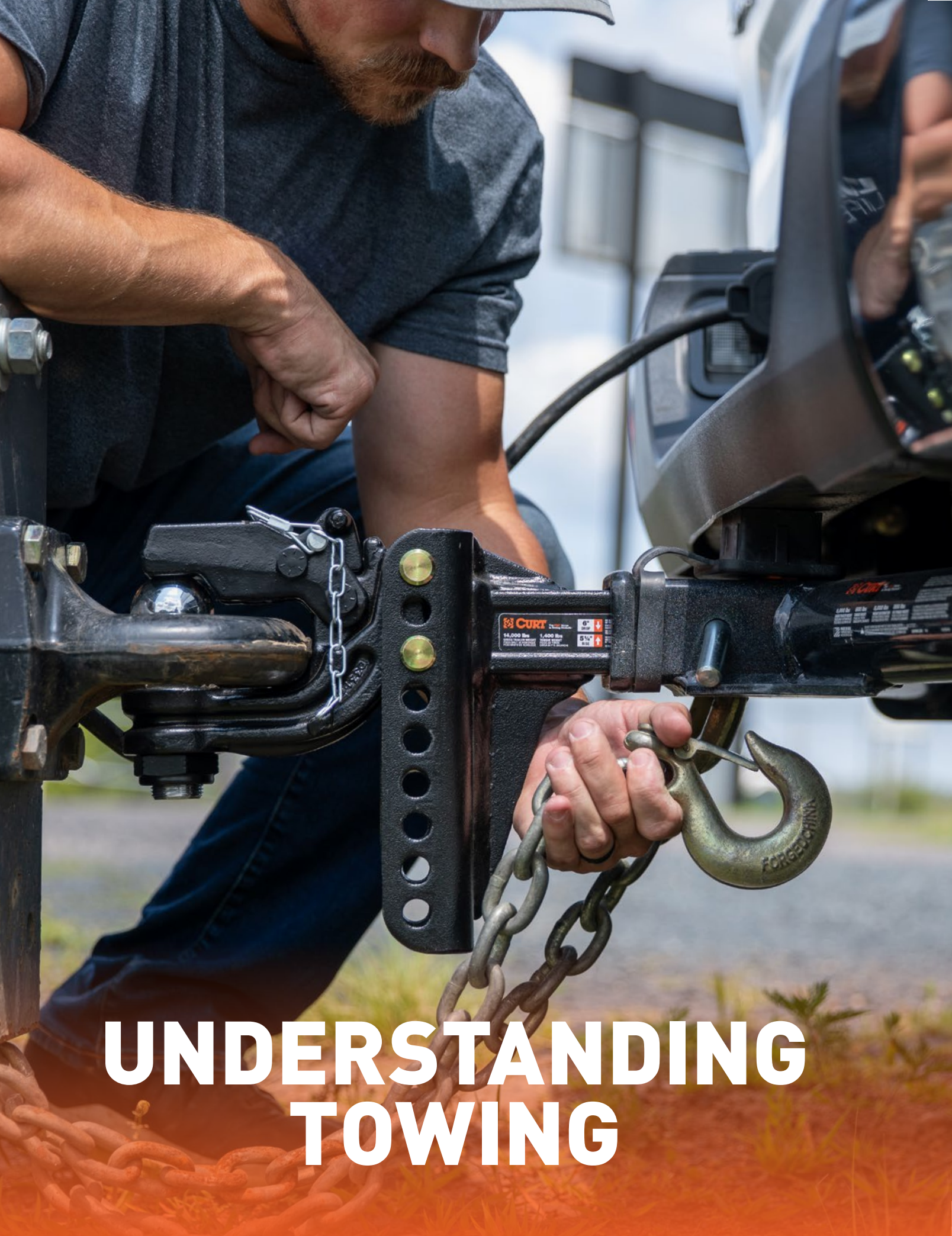

UNDERSTANDING TOWING

FOR MORE INFORMATION



| CURT University

This self-serve tool is a one-stop shop for marketing resources, including presentations, flyers, merchandising, videos, and more!

TOWING 101

A beginner's guide to the basics of towing

visit curtmfg.com/introduction

| Towing 101

This beginner's guide is perfect for educating new employees. It covers all key aspects of towing, from hitch selection to trailer hook-up.

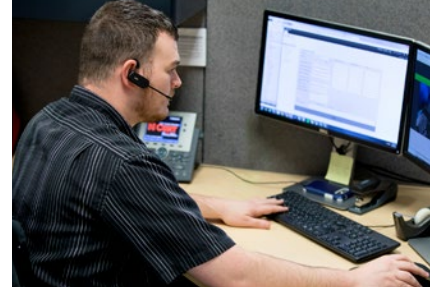

| Product Support Team

If you have questions about CURT products or how to use them, our Product Support Team is standing by. Simply call 877.287.8634.

SECTION INDEX



12
Towing
Basics



13
CURT
University

TOWING BASICS

Gross trailer weight (GTW)

The gross trailer weight is the total weight of a trailer and its cargo. For example, GTW = boat + trailer + cooler + fishing gear. It is vitally important to know the GTW to ensure safe towing.

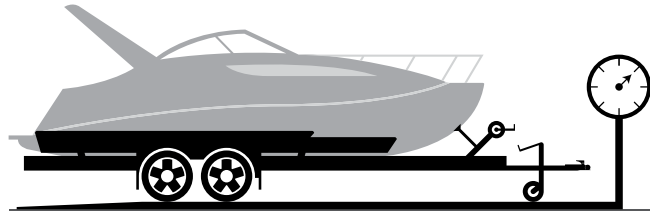

Weight carrying capacity (WC)

The weight carrying capacity is the total weight a trailer hitch is safely rated to tow without the assistance of a weight distribution system. When towing, the weight capacity is always limited to the lowest-rated towing component.

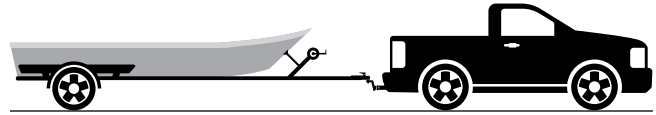

Tongue weight (TW)

Tongue weight is the downward force of the trailer at the coupling point. Proper TW should be about 10% to 15% of the GTW. TW can be measured using a commercial scale or bathroom scale*, following the method below.

Multiply scale reading by three

*only use a scale capable of estimated TW

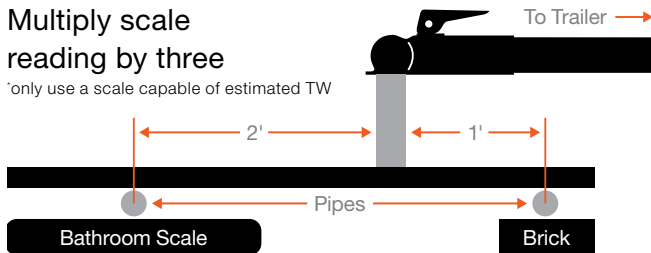

Weight distribution capacity (WD)

The weight distribution capacity is the maximum amount of weight a trailer hitch can safely tow with a weight distribution hitch installed. A weight distribution hitch distributes a portion of the TW across the vehicle and trailer to promote level towing. See page 186 for WD products.

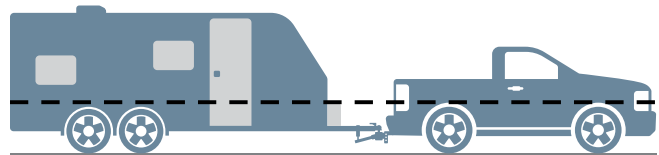

Measuring ball mount drop and rise

When selecting a ball mount, it is important to determine drop / rise for leveling the trailer. Use the diagram below to find this value. B minus A equals C. If C is negative, this indicates the amount of drop needed. If positive, it indicates rise.

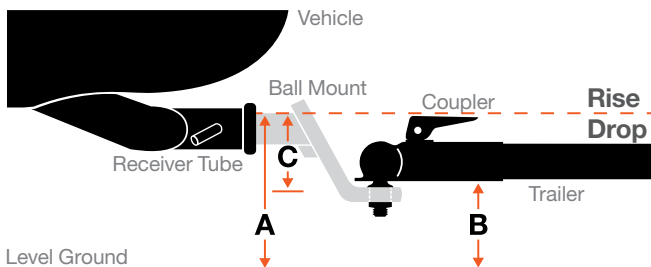

Level towing

Using a ball mount with the proper amount of drop or rise will allow for level towing across the trailer and vehicle. Without a level vehicle-trailer connection, the trailer may wander or sway and can lead to the driver's loss of control, leading to an accident.

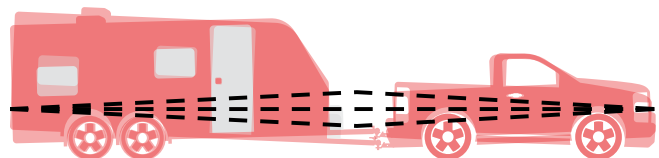



PUT OUR MARKETING ASSETS TO WORK FOR YOU!

CURT UNIVERSITY



Scan or visit
curtmfg.com/university



Photos

Our photo library contains nearly 100,000 professional photos of our products. This provides an accurate view of each part, a snapshot of key features, and a look at what's included in each package.

This library is available for use on your website and in your store!



Videos

Our in-house video team has produced over 1,300 videos with more published every week. Our primary focus is installation and feature videos, but we also have a number of educational how-tos.

Our videos can easily be embedded on your website through YouTube. In-store options are also available.



How-To Guides

When it comes to towing, users, both new and experienced, have questions. We offer a growing number of how-to guides on our website to help you provide answers.

Our Towing 101 guide is a great place to start, laying out the basics of equipment, installation and safe towing practices.



Literature

Our in-house creative team works tirelessly to publish a variety of high-caliber literature pieces, including everything from new product flyers to the in-depth catalog you're currently browsing!

Place our literature in your store to give your associates and customers a tangible reference to help them come to an informed buying decision.



Merchandising

We offer a number of custom-built displays to furnish your store and showcase our products in a professional light. Choose from floor models and planogram options.

We also offer posters, header cards, counter mats, and other signage that highlights the advantages of choosing CURT.



Presentations

Educate yourself and train your associates on the key selling points of our products. For each product category, we maintain high-quality training presentations, complete with unique selling points, photography, and videos.



TRAILER HITCHES

FEATURED PRODUCTS

Scan QR code for current applications or visit curtmfg.com



Rear-mount hitches

CURT is the industry leader in first-to-market hitch designs, and each one is engineered and tested to the highest safety standards.



Weld-on hitches

We've expanded our weld-on hitch offering to better accommodate service body trucks, including 20k and 18" drop options.



Front-mount hitches

CURT front hitches are vehicle specific and provide a convenient mount for your cargo carrier, snow plow, or winch.

PRODUCT INDEX



17

**Class 1 & 2
Trailer Hitches**

Made in USA



17

**Class 3 & 4
Trailer Hitches**

Made in USA



17

**Class 5
Trailer Hitches**

Made in USA



18

**Multi-Fit
Trailer Hitches**



18

**Bumper
Hitches**

Made in USA



24

**Weld-On
Trailer Hitches**

Made in USA



25

**Adjustable
RV Hitches**

Made in USA



25

**RV Bumper
Hitches**

Made in USA



26

**Front Mount
Hitches**

Made in USA



CUSTOM-FIT TRAILER HITCHES

Scan for current applications or visit curtmfg.com



CURT custom hitches are broken out into five distinct classes based on their receiver tube size and weight ratings. Within these classes, weight ratings vary by part number. Each hitch is made for vehicle-specific applications and is always limited by the lowest-rated towing component.

Product Details

- Made with a vehicle-specific design for a custom fit
- Tested for safety in accordance with SAE J684
- Precisely welded for superior strength and fit
- Protected by a durable black powder coat finish
- Co-cured in a rust-resistant liquid A-coat
- Equipped with an open-back receiver for easy cleaning
- Limited lifetime warranty (see last page for details)



Advantages of CURT trailer hitches



Proud to manufacture all of our custom hitches in the USA (may include imported hardware)



Constructed with a combination of manual and robotic welding for superior strength and fit



A-coat applied inside and out and co-cured with powder coat for maximum rust resistance



Industry-leading, in-house safety and performance testing, according to SAE specifications



CUSTOM-FIT TRAILER HITCHES

For trailer hitch application guide go to page 34

Below is a quick comparison of the five different hitch classes as well as front mount hitches.

1 1/4 INCH CLASS 1 & 2 HITCHES

- Available with included ball mount, pin and clip (see page 32 for ordering options)



2 INCH CLASS 3 & 4 HITCHES

- Many models feature a concealed main body for an OE look



2 INCH & 2 1/2 INCH CLASS 5 HITCHES

- Constructed with a large, powerful main body
- Features wide safety chain openings for heavy-duty hooks



2 INCH FRONT MOUNT HITCHES

- Ideal for attaching a snow plow, cargo carrier or other accessory
- Up to 9,000 lbs. straight-line pull
- Easily maneuver a trailer into a tight spot
- See page 26 for application information



QUICK COMPARISON

Hitch Class	Rec. Size	GTW	TW	WD	WDTW	Finish
Class 1	1-1/4"	Up to 2,000 lbs.	Up to 200 lbs.	--	--	Gloss black
Class 2	1-1/4"	Up to 3,500 lbs.	Up to 350 lbs.	--	--	Gloss black
Class 3	2"	Up to 8,000 lbs.	Up to 800 lbs.	Up to 12,000 lbs.	Up to 1,200 lbs.	Gloss black
Class 4	2"	Up to 10,000 lbs.	Up to 1,000 lbs.	Up to 12,000 lbs.	Up to 1,200 lbs.	Gloss black
Class 5 - Xtra Duty	2"	Up to 17,000 lbs.	Up to 2,550 lbs.	Up to 17,000 lbs.	Up to 2,550 lbs.	Carbide black
Class 5 - Commercial Duty	2-1/2"	Up to 20,000 lbs.	Up to 2,700 lbs.	Up to 20,000 lbs.	Up to 2,700 lbs.	Carbide black
Front Mount	2"	Up to 5,000 lbs.	Up to 500 lbs.	--	--	Gloss black

Trailer hitch weight ratings vary by part number and are limited to vehicle manufacturer's stated capacities

MULTI-FIT TRAILER HITCHES

For retail settings or if a CURT custom hitch is not available for a particular vehicle, a multi-fit hitch is a dependable alternative. These hitches are made to fit a wide variety of vehicle applications, and most require little or no drilling for installation.

Product Details

- Versatile frame design to fit a variety of vehicles
- Available with 1-1/4" or 2" receiver tube
- Gross trailer weight ratings ranging from 3,500 lbs. up to 15,000 lbs.
- Select models compatible with WD hitches
- Requires little or no drilling on most models
- Robotically welded for superior strength and fit
- Includes mounting hardware (grade-8 on #15510, #15511)
- Durable gloss black powder coat finish
- Informative, full-color retail box (excluding #15510, #15511)
- Limited lifetime warranty (see last page for details)



Multi-fit hitches are designed to perfectly balance a wide range of fitment and an integrated look, providing a safe, secure towing solution

Scan for current applications or visit curtmfg.com



Did You Know?

The class 3 #13902 and #13903 provide a comprehensive retail option for pickups.



2
INCH

BUMPER HITCHES

- Includes safety chain hookups and imported mounting hardware
- Limited lifetime warranty (see last page for details)



19030



19031

Part #	Fits	GTW / TW	Bolt Pattern
19030	Most factory steel bumpers (bolts onto the bottom of step bumper)	5,000 / 500 lbs.	8-1/2" width on center
19031*	Westin and DMI bumpers (bolts onto the bottom of step bumper)	5,000 / 500 lbs.	10-1/2" width on center

* Continued while supplies last

MULTI-FIT HITCH APPLICATION GUIDE

Make / Model	Style	Years	Rec. Size	Part #	Foot Notes	GTW / TW (lbs.)	WD / WDTW (lbs.)
Chevrolet							
Astro	Extended chassis	85 - 05	1.25	12923	4, 5	3.5 / 350	--
			2	13900	4, 5	5.0 / 500	--
Blazer	--	92 - 94	2	13900	4	5.0 / 500	--
		83 - 94	1.25	12923	4	3.5 / 350	--
	Full-size	80 - 91	2	13900	4	5.0 / 500	--
C/K 1500	Excluding stepside and king cab	62 - 99	1.25	12923	4	3.5 / 350	--
	8' bed	88 - 99	2	13900	4	5.0 / 500	--
	8' bed, excluding stepside	62 - 87	2	13900	4	5.0 / 500	--
			2	15511	2	15 / 1500	16 / 1600
			2	15510	1	15 / 1500	16 / 1600
C/K 2500	Excluding stepside and king cab	62 - 99	1.25	12923	4	3.5 / 350	--
	8' bed	88 - 99	2	13900	4	5.0 / 500	--
	8' bed, excluding stepside	62 - 87	2	13900	4	5.0 / 500	--
			2	15511	2	15 / 1500	16 / 1600
			2	15510	1	15 / 1500	16 / 1600
	Cab & chassis	88 - 99	2	15510	1	15 / 1500	16 / 1600
			2	15511	2	15 / 1500	16 / 1600
2			15510	1	15 / 1500	16 / 1600	
C/K 3500	8' bed	62 - 87	2	15510	1	15 / 1500	16 / 1600
			2	15511	2	15 / 1500	16 / 1600
	Cab & chassis	88 - 99	2	15510	1	15 / 1500	16 / 1600
			2	15511	2	15 / 1500	16 / 1600
			2	15510	1	15 / 1500	16 / 1600
Express	Full-size van	96 - 25	2	13900	4	5.0 / 500	--
G-Series	Full-size van	78 - 96	2	13900	4	5.0 / 500	--
S10	4WD, short bed	98 - 04	2	13900	4	5.0 / 500	--
	Long bed, excluding Baja	83 - 04	1.25	12923	4	3.5 / 350	--
			2	13900	4	5.0 / 500	--
Silverado 1500	--	99 - 18	2	13901*	--	5.0 / 500	7.5 / 750
			2	13902	--	8.0 / 800	12 / 1200
	8' bed	99 - 06	2	13900	4	5.0 / 500	--
Silverado 1500 Classic	--	07 - 07	2	13901*	--	5.0 / 500	7.5 / 750
			2	13902	--	8.0 / 800	12 / 1200
	8' bed	07 - 07	2	13900	4	5.0 / 500	--
Silverado 1500 HD	--	05 - 06	2	13901*	--	5.0 / 500	7.5 / 750
		01 - 03	2	13901*	--	5.0 / 500	7.5 / 750
Silverado 1500 HD Classic	--	07 - 07	2	13901*	--	5.0 / 500	7.5 / 750
Silverado 1500 LD	--	19 - 19	2	13901*	--	5.0 / 500	7.5 / 750
			2	13902	--	8.0 / 800	12 / 1200
Silverado 2500	--	99 - 04	2	13901*	--	5.0 / 500	7.5 / 750
			2	13902	--	8.0 / 800	12 / 1200
	8' bed	99 - 04	2	13900	4	5.0 / 500	--
Silverado 2500 HD	--	01 - 19	2	13902	--	8.0 / 800	12 / 1200
		01 - 14	2	13901*	--	5.0 / 500	7.5 / 750
	8' bed	01 - 06	2	13900	4	5.0 / 500	--
Silverado 2500 HD Classic	--	07 - 07	2	13901*	--	5.0 / 500	7.5 / 750
			2	13902	--	8.0 / 800	12 / 1200
	8' bed	07 - 07	2	13900	4	5.0 / 500	--

1. Receiver tube drops 5-1/2" on the rear of the vehicle
2. Receiver tube drops 7-1/2" on the rear of the vehicle
3. Two sets of mounting brackets included, only one set will be used based on application

4. Adjustable frame
 5. Spare tire may need relocating
 6. Excluding 20" spare tire
- * Continued while supplies last

Applications continued on the following page

Make / Model	Style	Years	Rec. Size	Part #	Foot Notes	GTW / TW (lbs.)	WD / WDTW (lbs.)
Chevrolet (continued)							
Silverado 3500	--	01 - 06	2	13901*	--	5.0 / 500	7.5 / 750
			2	13902	--	8.0 / 800	12 / 1200
Silverado 3500 Classic	8' bed	01 - 06	2	13900	4	5.0 / 500	--
	--		2	13901*	--	5.0 / 500	7.5 / 750
Silverado 3500 HD	8' bed	01 - 07	2	13900	4	5.0 / 500	--
		07 - 19	2	13902	--	8.0 / 800	12 / 1200
Suburban	--	92 - 06	2	13901*	--	5.0 / 500	7.5 / 750
			2	12923	4	3.5 / 350	--
Tahoe	--	95 - 06	2	13900	4	5.0 / 500	--
			2	13900	4	5.0 / 500	--
Venture	--	97 - 04	1.25	12923	4	3.5 / 350	--
			2	13900	4	5.0 / 500	--
Chrysler							
Town & Country	Excluding Stow-n-Go	88 - 07	1.25	12923	4	3.5 / 350	--
			2	13900	4	5.0 / 500	--
Voyager	--	00 - 03	2	13900	4	5.0 / 500	--
Dodge							
Caravan	Excluding Stow-n-Go	88 - 07	1.25	12923	4	3.5 / 350	--
			2	13900	4	5.0 / 500	--
Dakota	--	86 - 04	1.25	12923	4	3.5 / 350	--
			2	13900	4	5.0 / 500	--
D/W Series Pickups	Excluding 1-ton	62 - 87	2	13900	4	5.0 / 500	--
	--	72 - 93	2	15510	1	15 / 1500	16 / 1600
			2	15511	2	15 / 1500	16 / 1600
Ram 1500	--	02 - 10	2	13902	--	8.0 / 800	12 / 1200
		94 - 01	1.25	12923	4	3.5 / 350	--
Ram 2500	--	03 - 10	2	13902	--	8.0 / 800	12 / 1200
		94 - 01	1.25	12923	4	3.5 / 350	--
Ram 3500	--	03 - 10	2	13902	--	8.0 / 800	12 / 1200
		94 - 01	1.25	12923	4	3.5 / 350	--
Ramcharger	--	78 - 93	1.25	12923	4	3.5 / 350	--
			2	13900	4	5.0 / 500	--
Ford							
Aerostar	Extended chassis	86 - 97	2	13900	4	5.0 / 500	--
Bronco	--	78 - 97	1.25	12923	4	3.5 / 350	--
			2	13900	4	5.0 / 500	--
Bronco II	--	84 - 90	1.25	12923	4	3.5 / 350	--
			2	13900	4	5.0 / 500	--
Escape	--	01 - 04	2	13900	4	5.0 / 500	--
E-150	--	03 - 14	2	13900	4	5.0 / 500	--
E-150 Econoline	--	80 - 98	1.25	12923	4	3.5 / 350	--
		80 - 02	2	13900	4	5.0 / 500	--
E-250	--	03 - 14	2	13900	4	5.0 / 500	--
E-250 Econoline	--	80 - 98	1.25	12923	4	3.5 / 350	--
		80 - 02	2	13900	4	5.0 / 500	--

1. Receiver tube drops 5-1/2" on the rear of the vehicle
2. Receiver tube drops 7-1/2" on the rear of the vehicle
3. Two sets of mounting brackets included, only one set will be used based on application

4. Adjustable frame
 5. Spare tire may need relocating
 6. Excluding 20" spare tire
- * Continued while supplies last

Applications continued on the following page

Make / Model	Style	Years	Rec. Size	Part #	Foot Notes	GTW / TW (lbs.)	WD / WDTW (lbs.)
Ford (continued)							
F-100	--	67 - 83	2	15510	1	15 / 1500	16 / 1600
			2	15511	2	15 / 1500	16 / 1600
	Excluding flareside	67 - 83	1.25	12923	4	3.5 / 350	--
			2	13900	4	5.0 / 500	--
F-150	--	06 - 20	2	13903*	3	8.0 / 800	12 / 1200
			2	13901*	--	5.0 / 500	7.5 / 750
		2	13902	--	8.0 / 800	12 / 1200	
	6' flareside bed	97 - 03	2	13900	4, 5	5.0 / 500	--
	8' bed	99 - 03	2	13900	4	5.0 / 500	--
	--	75 - 96	2	15510	1	15 / 1500	16 / 1600
			2	15511	2	15 / 1500	16 / 1600
	Excluding flareside	75 - 96	1.25	12923	4	3.5 / 350	--
			2	13900	4	5.0 / 500	--
	F-150 Heritage	--	04 - 04	2	13901*	--	5.0 / 500
2				13902	--	8.0 / 800	12 / 1200
F-250	--	97 - 99	2	13901*	--	5.0 / 500	7.5 / 750
			2	15510	1	15 / 1500	16 / 1600
		2	15511	2	15 / 1500	16 / 1600	
	Excluding flareside	74 - 99	1.25	12923	4	3.5 / 350	--
2			13900	4	5.0 / 500	--	
F-250 Super Duty	--	99 - 16	2	13901*	--	5.0 / 500	7.5 / 750
			2	13902	--	8.0 / 800	12 / 1200
	8' bed	99 - 16	2	13900	4, 6	5.0 / 500	--
F-350	--	67 - 97	2	15510	1	15 / 1500	16 / 1600
			2	15511	2	15 / 1500	16 / 1600
F-350 Super Duty	8' bed	99 - 16	2	13900	4, 6	5.0 / 500	--
			2	13901*	--	5.0 / 500	7.5 / 750
			2	13902	--	8.0 / 800	12 / 1200
F-450 Super Duty	Crew cab	08 - 16	2	13901*	--	5.0 / 500	7.5 / 750
			2	13902	--	8.0 / 800	12 / 1200
	2WD, cab & chassis	99 - 07	2	15510	1	15 / 1500	16 / 1600
2	15511		2	15 / 1500	16 / 1600		
Ranger	--	83 - 11	1.25	12923	4	3.5 / 350	--
	Short bed, excluding flareside	83 - 06	2	13900	4	5.0 / 500	--
	Long bed	83 - 11	2	13900	4, 5	5.0 / 500	--
Windstar	--	99 - 03	2	13900	4	5.0 / 500	--
GMC							
C/K 1500	Excluding stepside and king cab	62 - 99	1.25	12923	4	3.5 / 350	--
	8' bed	88 - 99	2	13900	4	5.0 / 500	--
	8' bed, excluding stepside	62 - 87	2	13900	4	5.0 / 500	--
			2	15511	2	15 / 1500	16 / 1600
			2	15510	1	15 / 1500	16 / 1600
C/K 2500	Excluding stepside and king cab	62 - 99	1.25	12923	4	3.5 / 350	--
	8' bed	88 - 99	2	13900	4	5.0 / 500	--
	8' bed, excluding stepside	62 - 87	2	13900	4	5.0 / 500	--
			2	15511	2	15 / 1500	16 / 1600
			2	15510	1	15 / 1500	16 / 1600
	Cab & chassis	88 - 99	2	15510	1	15 / 1500	16 / 1600
			2	15511	2	15 / 1500	16 / 1600

1. Receiver tube drops 5-1/2" on the rear of the vehicle
2. Receiver tube drops 7-1/2" on the rear of the vehicle
3. Two sets of mounting brackets included, only one set will be used based on application

4. Adjustable frame
 5. Spare tire may need relocating
 6. Excluding 20" spare tire
- * Continued while supplies last

Applications continued on the following page

Make / Model	Style	Years	Rec. Size	Part #	Foot Notes	GTW / TW (lbs.)	WD / WDTW (lbs.)
GMC (continued)							
C/K 3500	8' bed	62 - 87	2	15510	1	15 / 1500	16 / 1600
			2	15511	2	15 / 1500	16 / 1600
	Cab & chassis	88 - 99	2	15510	1	15 / 1500	16 / 1600
			2	15511	2	15 / 1500	16 / 1600
G-Series	Full-size van	78 - 96	2	13900	4	5.0 / 500	--
Jimmy	--	92 - 94	2	13900	4	5.0 / 500	--
		83 - 94	1.25	12923	4	3.5 / 350	--
	Full-size	80 - 91	2	13900	4	5.0 / 500	--
Safari	Extended chassis	85 - 05	1.25	12923	4, 5	3.5 / 350	--
			2	13900	4, 5	5.0 / 500	--
Savana	Full-size van	96 - 25	2	13900	4	5.0 / 500	--
Sierra 1500	--	99 - 18	2	13901*	--	5.0 / 500	7.5 / 750
			2	13902	--	8.0 / 800	12 / 1200
	8' bed	99 - 06	2	13900	4	5.0 / 500	--
Sierra 1500 Classic	--	07 - 07	2	13901*	--	5.0 / 500	7.5 / 750
			2	13902	--	8.0 / 800	12 / 1200
	8' bed	07 - 07	2	13900	4	5.0 / 500	--
Sierra 1500 HD	--	05 - 06	2	13901*	--	5.0 / 500	7.5 / 750
		01 - 03	2	13901*	--	5.0 / 500	7.5 / 750
Sierra 1500 HD Classic	--	07 - 07	2	13901*	--	5.0 / 500	7.5 / 750
Sierra 1500 Limited	--	19 - 19	2	13901*	--	5.0 / 500	7.5 / 750
			2	13902	--	8.0 / 800	12 / 1200
Sierra 2500	--	99 - 04	2	13901*	--	5.0 / 500	7.5 / 750
			2	13902	--	8.0 / 800	12 / 1200
	8' bed	99 - 04	2	13900	4	5.0 / 500	--
Sierra 2500 HD	--	01 - 19	2	13902	--	8.0 / 800	12 / 1200
		01 - 14	2	13901*	--	5.0 / 500	7.5 / 750
	8' bed	01 - 06	2	13900	4	5.0 / 500	--
Sierra 2500 HD Classic	--	07 - 07	2	13901*	--	5.0 / 500	7.5 / 750
			2	13902	--	8.0 / 800	12 / 1200
	8' bed	07 - 07	2	13900	4	5.0 / 500	--
Sierra 3500	--	01 - 06	2	13901*	--	5.0 / 500	7.5 / 750
			2	13902	--	8.0 / 800	12 / 1200
	8' bed	01 - 06	2	13900	4	5.0 / 500	--
Sierra 3500 Classic	--	07 - 07	2	13901*	--	5.0 / 500	7.5 / 750
			2	13902	--	8.0 / 800	12 / 1200
	8' bed	01 - 07	2	13900	4	5.0 / 500	--
Sierra 3500 HD	--	07 - 19	2	13902	--	8.0 / 800	12 / 1200
		07 - 14	2	13901*	--	5.0 / 500	7.5 / 750
Sonoma	4WD, short bed	98 - 04	2	13900	4	5.0 / 500	--
	Long bed	83 - 04	1.25	12923	4	3.5 / 350	--
			2	13900	4	5.0 / 500	--
Suburban	--	92 - 99	1.25	12923	4	3.5 / 350	--
			2	13900	4	5.0 / 500	--
Yukon	--	92 - 06	2	13900	4	5.0 / 500	--
Yukon XL 1500	--	00 - 06	2	13900	4	5.0 / 500	--
Yukon XL 2500	--	00 - 06	2	13900	4	5.0 / 500	--

1. Receiver tube drops 5-1/2" on the rear of the vehicle
2. Receiver tube drops 7-1/2" on the rear of the vehicle
3. Two sets of mounting brackets included, only one set will be used based on application

4. Adjustable frame
 5. Spare tire may need relocating
 6. Excluding 20" spare tire
- * Continued while supplies last

Applications continued on the following page

Make / Model	Style	Years	Rec. Size	Part #	Foot Notes	GTW / TW (lbs.)	WD / WDTW (lbs.)
Isuzu							
Hombre	4WD	98 - 00	2	13900	4	5.0 / 500	--
Jeep							
Cherokee XJ	--	84 - 01	2	13900	4	5.0 / 500	--
Grand Cherokee	--	93 - 98	2	13900	4	5.0 / 500	--
Liberty	--	02 - 06	2	13900	4	5.0 / 500	--
Wagoneer	--	87 - 90	1.25	12923	4	3.5 / 350	--
Mazda							
Pickup	--	90 - 06	2	13900	4	5.0 / 500	--
Tribute	--	01 - 04	2	13900	4	5.0 / 500	--
Nissan							
Frontier	4.5' or 6.25' bed	87 - 04	2	13900	4	5.0 / 500	--
Pickup	4.5' bed	87 - 04	2	13900	4	5.0 / 500	--
	6' bed	87 - 94	1.25	12923	4	3.5 / 350	--
		87 - 04	2	13900	4	5.0 / 500	--
Oldsmobile							
Bravada	--	91 - 94	1.25	12923	4	3.5 / 350	--
Silhouette	--	97 - 05	1.25	12923	4	3.5 / 350	--
Plymouth							
Trail Duster	--	74 - 91	1.25	12923	4	3.5 / 350	--
			2	13900	4	5.0 / 500	--
Voyager	--	88 - 98	1.25	12923	4	3.5 / 350	--
		84 - 03	2	13900	4	5.0 / 500	--
Pontiac							
6000	--	82 - 84	1.25	12923	4	3.5 / 350	--
Montana	--	99 - 06	1.25	12923	4	3.5 / 350	--
Trans Sport	--	97 - 98	1.25	12923	4	3.5 / 350	--
Ram							
1500	--	11 - 18	2	13902	--	8.0 / 800	12 / 1200
1500 Classic	--	19 - 23	2	13902	--	8.0 / 800	12 / 1200
2500	--	11 - 19	2	13902	--	8.0 / 800	12 / 1200
3500	--	11 - 19	2	13902	--	8.0 / 800	12 / 1200
Toyota							
Pickup	6' bed, excluding T100	87 - 95	1.25	12923	4	3.5 / 350	--
	8' bed, excluding T100	87 - 94	2	13900	4	5.0 / 500	--
Tundra	--	00 - 06	2	13900	4	5.0 / 500	--

1. Receiver tube drops 5-1/2" on the rear of the vehicle
2. Receiver tube drops 7-1/2" on the rear of the vehicle
3. Two sets of mounting brackets included, only one set will be used based on application

4. Adjustable frame
 5. Spare tire may need relocating
 6. Excluding 20" spare tire
- * Continued while supplies last



2
INCH

UNIVERSAL WELD-ON TRAILER HITCHES

- Compatible with most service body trucks and other large pickup trucks
- Adjustable frame fits a variety of vehicles (side plates do not come pre-welded)
- Class 5 ratings with capacities available up to 20,000 lbs. Side plates must be welded 42" apart or less to achieve 20K rating (select models)
- Weld locations must be sanded prior to welding for optimal strength
- Co-cured in a rust-resistant liquid A-coat
- Protected by a durable black powder coat finish
- Protected by a durable carbide black powder coat finish (#15901, #15902, #15903 only)
- Tested for safety in accordance with SAE J684
- Limited lifetime warranty (see last page for details)

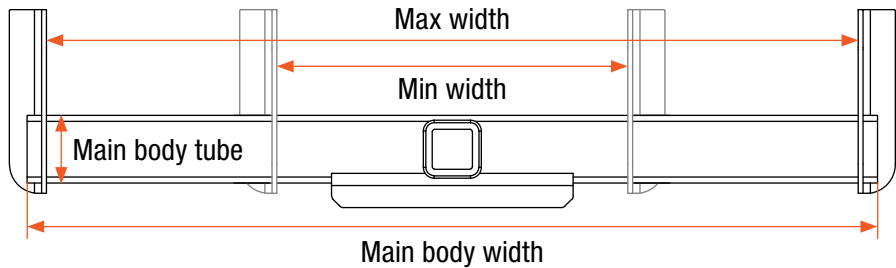
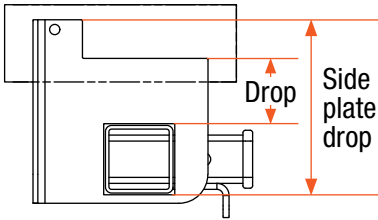

Part #	GTW	Receiver Tube Size	Main Body Width	Main Body Tube	Side Plate Drop	Drop	Max Width	Min Width	Finish
15901	15,000 lbs.	2"	45"	4" x 4"	9-1/2"	3-1/8"	43"	18"	Carbide black
15902	15,000 lbs.	2"	45"	4" x 4"	18"	11-1/2"	43"	18"	Carbide black
15903	15,000 lbs.	2"	62"	4" x 4"	18"	11-1/2"	60"	18"	Carbide black
15920	16,000 lbs.	2"	44"	3-1/2" x 3-1/2"	Not included	--	--	--	Gloss black
15927	16,000 lbs.	2"	44"	3-1/2" x 3-1/2"	9"	3 1/8"	42"	18"	Gloss black
15928	16,000 lbs.	2"	44"	3-1/2" x 3-1/2"	18"	11-1/2"	42"	18"	Gloss black
15921*	16,000 lbs.	2-1/2"	44"	3-1/2" x 3-1/2"	Not included	--	--	--	Gloss black
15922*	16,000 lbs.	2-1/2"	62"	3-1/2" x 3-1/2"	Not included	--	--	--	Gloss black
15923*	20,000 lbs.	2-1/2"	44"	3-1/2" x 3-1/2"	9"	3-1/4"	42"	18"	Gloss black
15924*	20,000 lbs.	2-1/2"	44"	3-1/2" x 3-1/2"	18"	11-1/2"	42"	18"	Gloss black
15925*	20,000 lbs.	2-1/2"	62"	3-1/2" x 3-1/2"	9"	3-1/4"	60"	18"	Gloss black
15926*	20,000 lbs.	2-1/2"	62"	3-1/2" x 3-1/2"	18"	11-1/2"	60"	18"	Gloss black

*Side plates must be welded 42" apart or less to achieve 20K rating



2
INCH

ADJUSTABLE RV TRAILER HITCHES

- Co-cured in a rust-resistant liquid A-coat and protected by a gloss black powder coat finish
- May include imported installation hardware
- Limited lifetime warranty (see last page for details)



Designed for towing a trailer or small vehicle behind an RV

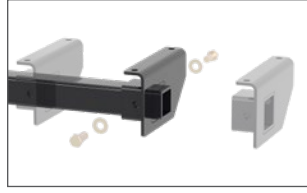

Three-piece, adjustable design fits multiple frame sizes



13704

Part #	GTW / TW	WD / WDTW	Frame	Drop
13701	5,000 / 500 lbs.	6,000 / 600 lbs.	Fits box frames up to 51" wide	2"
13702	5,000 / 500 lbs.	6,000 / 600 lbs.	Fits box frames up to 51" wide	--
13704	5,000 / 500 lbs.	--	Fits box frames up to 66" wide	--
13703	3,500 / 350 lbs.	--	Fits box, C-channel and I-beam frames up to 72" wide	--



2
INCH

RV BUMPER HITCHES

- Includes safety chain hookups and imported grade 8 mounting hardware
- Limited lifetime warranty (see last page for details)

Pkg #	GTW / TW	Fits
19100	3,500 / 350 lbs.	4" x 4" channel bumpers
19101	3,500 / 350 lbs.	2" x 4" channel bumpers



19100



19101

FISH WIRE

- Makes it easier to lead bolts and spacers through tough-to-reach holes
- Ideal for installing a trailer hitch on a vehicle with a hollow frame
- Coiled end accepts threaded bolts



58390



58410



58400



58430

Part #	Length	Coil Diameter	Material
58390	18"	3/8"	Spring steel
58410	18"	7/16"	Spring steel
58400	18"	1/2"	Spring steel
58430	18"	5/8"	Spring steel



Ideal for installing a trailer hitch on a vehicle with a hollow frame

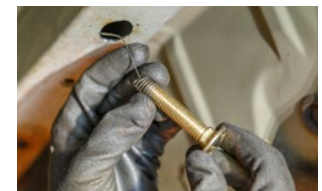

Makes it easier to lead hardware through tough-to-reach holes



ADD MORE FUNCTIONALITY TO YOUR VEHICLE



2

INCH

FRONT MOUNT HITCHES

Scan for current applications
or visit curtmfg.com



- 2" x 2" receiver tube opening
- Up to 5,000 lbs. GTW / 500 lbs. TW
- Compatible with a tow hook or shackle mount (9,000 lbs. straight-line pull)
- Allows for easy maneuvering of a trailer into a tight spot
- Tested for safety in accordance with SAE J684
- Precisely welded for superior strength and fit
- May include imported installation hardware (grade-8)
- Limited lifetime warranty (see last page for details)



Ideal for attaching a snow plow, cargo carrier or other front hitch mount accessories

Make / Model	Style	Years	Part #	Foot Notes	GTW / TW (lbs.)	Price Code	Install Time	Main Body
Buick								
Rainier	--	04 - 07	31055	D, ●	350 / 3,500	77	45	Exposed
Cadillac								
Escalade	Excluding Hybrid	07 - 20	31012	D	500 / 5,000	51	45	Concealed
	--	00 - 06	31302	D, ●	500 / 5,000	65	60	Concealed
Escalade EXT	--	07 - 13	31012	D	500 / 5,000	51	45	Concealed
Chevrolet								
Avalanche	Excluding Z71	07 - 13	31012	D	500 / 5,000	51	45	Concealed
Avalanche 1500	--	02 - 06	31302	D, ●	500 / 5,000	65	60	Concealed
Avalanche 2500	--	02 - 06	31302	D, ●	500 / 5,000	65	60	Concealed
Blazer	4WD, excluding ZR2	96 - 04	31021	●	350 / 3,500	27	30	Exposed
	--	92 - 94	31042	●	500 / 5,000	37	30	Concealed
C1500	--	88 - 99	31042	●	500 / 5,000	37	30	Concealed
C1500 Suburban	--	92 - 99	31043	--	500 / 5,000	45	30	Exposed
C2500	--	88 - 00	31043	--	500 / 5,000	45	30	Exposed
C2500 Suburban	--	92 - 99	31043	--	500 / 5,000	45	30	Exposed

● = No drilling required
D = Minor fascia trim

* Continued while supplies last

Applications continued on the following page

Make / Model	Style	Years	Part #	Foot Notes	GTW / TW (lbs.)	Price Code	Install Time	Main Body
Chevrolet (continued)								
C3500	--	88 - 00	31043	--	500 / 5,000	45	30	Exposed
Colorado	Excluding ZR2	15 - 22	31074	D, ●	500 / 5,000	37	45	Concealed
	Excluding Z71 with front stabilizer bar	10 - 12	31221	D, ●	500 / 5,000	56	30	Concealed
	--	04 - 09	31221	D, ●	500 / 5,000	56	30	Concealed
Express 1500	--	96 - 03	31016	--	500 / 5,000	25	35	Exposed
Express 2500	--	96 - 03	31016	--	500 / 5,000	25	35	Exposed
Express 3500	--	96 - 03	31016	--	500 / 5,000	25	35	Exposed
K1500	--	88 - 99	31042	●	500 / 5,000	37	30	Concealed
K1500 Suburban	--	92 - 99	31042	●	500 / 5,000	37	30	Concealed
K2500	--	88 - 00	31042	●	500 / 5,000	37	30	Concealed
K2500 Suburban	--	92 - 99	31042	●	500 / 5,000	37	30	Concealed
K3500	--	88 - 00	31042	●	500 / 5,000	37	30	Concealed
S10	4WD, excluding ZR2	94 - 04	31021	●	350 / 3,500	27	30	Exposed
Silverado 1500	Excluding LTZ, High Country, ZR2, diesel, or Max Trailering package	22 - 25	31092	--	500 / 5,000	43	60	Concealed
	Excluding 2.7L or 3.0L	19 - 21	31088	●	500 / 5,000	43	30	Concealed
	--	14 - 18	31069	D	500 / 5,000	37	45	Concealed
	--	14 - 18	31012	D	500 / 5,000	51	45	Concealed
	--	07 - 13	31322	D, ●	500 / 5,000	45	30	Concealed
--	99 - 06	31302	D, ●	500 / 5,000	65	60	Concealed	
Silverado 1500 Classic	--	07 - 07	31302	D, ●	500 / 5,000	65	60	Concealed
Silverado 1500 HD	--	01 - 06	31108	D, ●	500 / 5,000	45	30	Concealed
Silverado 1500 HD Classic	--	07 - 07	31108	D, ●	500 / 5,000	45	30	Concealed
Silverado 1500 LD	--	19 - 19	31069	D	500 / 5,000	37	45	Concealed
		19 - 19	31012	D	500 / 5,000	51	45	Concealed
Silverado 1500 LTD	Excluding 2.7L or 3.0L	22 - 22	31088	●	500 / 5,000	43	30	Concealed
Silverado 2500	--	99 - 04	31108	D, ●	500 / 5,000	45	30	Concealed
Silverado 2500 HD	--	20 - 25	31091	●	500 / 5,000	35	60	Concealed
		15 - 19	31071	●	500 / 5,000	35	30	Concealed
		11 - 14	31023	D, ●	500 / 5,000	17	30	Concealed
		07 - 10	31109	●	500 / 5,000	37	30	Concealed
		01 - 06	31108	D, ●	500 / 5,000	45	30	Concealed
Silverado 2500 HD Classic	--	07 - 07	31108	D, ●	500 / 5,000	45	30	Concealed
Silverado 3500	--	01 - 06	31108	D, ●	500 / 5,000	45	30	Concealed
Silverado 3500 Classic	--	07 - 07	31108	D, ●	500 / 5,000	45	30	Concealed
Silverado 3500 HD	--	20 - 25	31091	●	500 / 5,000	35	60	Concealed
		15 - 19	31071	●	500 / 5,000	35	30	Concealed
		11 - 14	31023	D, ●	500 / 5,000	17	30	Concealed
		08 - 10	31109	●	500 / 5,000	37	30	Concealed
Suburban	--	15 - 20	31073	D	500 / 5,000	35	45	Concealed
Suburban 1500	--	07 - 14	31012	D	500 / 5,000	51	45	Concealed
		00 - 06	31302	D, ●	500 / 5,000	65	60	Concealed
		01 - 06	31108	D, ●	500 / 5,000	45	30	Concealed
Suburban 2500	--	01 - 06	31108	D, ●	500 / 5,000	45	30	Concealed
Tahoe	Excluding PPV or SSV	15 - 20	31073	D	500 / 5,000	35	45	Concealed
	Excluding Hybrid	07 - 14	31012	D	500 / 5,000	51	45	Concealed
	--	00 - 06	31302	D, ●	500 / 5,000	65	60	Concealed
	--	95 - 99	31042	●	500 / 5,000	37	30	Concealed
Trailblazer	--	02 - 09	31055	D, ●	350 / 3,500	77	45	Exposed

● = No drilling required
D = Minor fascia trim

* Continued while supplies last

Applications continued on the following page

Make / Model	Style	Years	Part #	Foot Notes	GTW / TW (lbs.)	Price Code	Install Time	Main Body
Dodge								
Dakota	4WD	00 - 04	31080	●	350 / 3,500	71	40	Concealed
Durango	Excluding SRT	11 - 24	31033	D	300 / 3,000	67	35	Concealed
	--	00 - 03	31080	●	350 / 3,500	71	40	Concealed
Ram 1500	4WD	09 - 10	31374	D	500 / 5,000	39	30	Concealed
	Extended Crew Cab Pickup	06 - 08	31017	D	350 / 3,500	49	30	Exposed
	Excluding Extended Crew Cab Pickup	06 - 08	31320	D, ●	500 / 5,000	63	30	Concealed
	--	02 - 05	31320	D, ●	500 / 5,000	63	30	Concealed
	Excluding Sport	94 - 01	31604	--	500 / 5,000	61	45	Concealed
Ram 2500	4WD	10 - 10	31015	D, ●	500 / 5,000	46	30	Concealed
	--	03 - 09	31017	D	350 / 3,500	49	30	Exposed
	--	94 - 02	31604	--	500 / 5,000	61	45	Concealed
Ram 3500	Excluding Laramie	03 - 09	31017	D	350 / 3,500	49	30	Exposed
	--	94 - 02	31604	--	500 / 5,000	61	45	Concealed
Ford								
E-150	--	08 - 14	31053	D	500 / 5,000	33	30	Exposed
	--	03 - 07	33055	--	500 / 5,000	33	30	Concealed
E-150 Econoline	--	91 - 02	33055	--	500 / 5,000	33	30	Concealed
E-250	--	08 - 14	31053	D	500 / 5,000	33	30	Exposed
	--	03 - 07	33055	--	500 / 5,000	33	30	Concealed
E-250 Econoline	--	91 - 02	33055	--	500 / 5,000	33	30	Concealed
E-350 Econoline	--	91 - 98	33055	--	500 / 5,000	33	30	Concealed
E-350 Super Duty	--	08 - 14	31053	D	500 / 5,000	33	30	Exposed
	--	99 - 07	33055	--	500 / 5,000	33	30	Concealed
Excursion	--	00 - 05	31114	●	500 / 5,000	71	60	Concealed
Expedition	--	18 - 20	31083	●	500 / 5,000	45	30	Concealed
	--	09 - 17	31068	D, ●	500 / 5,000	56	30	Exposed
	4WD with Factory Tow Hooks	03 - 06	31352	D, ●	500 / 5,000	56	30	Concealed
		99 - 02	31038	●	500 / 5,000	46	45	Concealed
		97 - 98	31049	●	500 / 5,000	45	30	Concealed
		--	92 - 96	31026	--	500 / 5,000	63	30
Explorer	Excluding Sport	02 - 06	31540	D	500 / 5,000	37	30	Concealed
F-150	Excluding automatic deploying air dam	15 - 21	31083	●	500 / 5,000	45	30	Concealed
	--	09 - 14	31068	D, ●	500 / 5,000	56	30	Exposed
	--	04 - 08	31352	D, ●	500 / 5,000	56	30	Concealed
	4WD with Factory Tow Hooks	99 - 03	31038	●	500 / 5,000	46	45	Concealed
		97 - 98	31049	●	500 / 5,000	45	30	Concealed
	--	92 - 96	31026	--	500 / 5,000	63	30	Concealed
F-150 Heritage	4WD with Factory Tow Hooks	04 - 04	31038	●	500 / 5,000	46	45	Concealed
F-250	4WD with Factory Tow Hooks	99 - 99	31038	●	500 / 5,000	46	45	Concealed
		97 - 98	31049	●	500 / 5,000	45	30	Concealed
	4WD	92 - 97	31310	●	500 / 5,000	37	30	Concealed
F-250 Super Duty	--	17 - 24	31078	D, ●	500 / 5,000	49	30	Concealed
	4WD	11 - 16	31018	D, ●	500 / 5,000	55	45	Concealed
	--	08 - 10	31008	D, ●	500 / 5,000	37	30	Concealed
	--	04 - 07	31114	●	500 / 5,000	71	60	Concealed
	With Blocker Beam	99 - 03	31014	--	500 / 5,000	71	45	Concealed
	Without Blocker Beam	99 - 03	31114	●	500 / 5,000	71	60	Concealed

● = No drilling required
D = Minor fascia trim

* Continued while supplies last

Applications continued on the following page

Make / Model	Style	Years	Part #	Foot Notes	GTW / TW (lbs.)	Price Code	Install Time	Main Body
Ford (continued)								
F-350	4WD	92 - 97	31310	●	500 / 5,000	37	30	Concealed
F-350 Super Duty	Excluding dual rear wheels	20 - 24	31078	D, ●	500 / 5,000	49	30	Concealed
	--	17 - 19	31078	D, ●	500 / 5,000	49	30	Concealed
	4WD	11 - 16	31018	D, ●	500 / 5,000	55	45	Concealed
	--	08 - 10	31008	D, ●	500 / 5,000	37	30	Concealed
		04 - 07	31114	●	500 / 5,000	71	60	Concealed
	With Blocker Beam	99 - 03	31014	--	500 / 5,000	71	45	Concealed
	Without Blocker Beam	99 - 03	31114	●	500 / 5,000	71	60	Concealed
F-450 Super Duty	--	17 - 19	31078	D, ●	500 / 5,000	49	30	Concealed
		08 - 10	31008	D, ●	500 / 5,000	37	30	Concealed
		99 - 07	31114	●	500 / 5,000	71	60	Concealed
F-550 Super Duty	Cab & Chassis with 34 In. Frame (O.D.)	08 - 10	31008	D, ●	500 / 5,000	37	30	Concealed
		99 - 07	31114	●	500 / 5,000	71	60	Concealed
Ranger	Except models with front cross member and Canadian built 2WD models	92 - 11	31063	D	350 / 3,500	63	30	Concealed
GMC								
C1500	--	88 - 99	31042	●	500 / 5,000	37	30	Concealed
C1500 Suburban	--	92 - 99	31043	--	500 / 5,000	45	30	Exposed
C2500	--	88 - 00	31043	--	500 / 5,000	45	30	Exposed
C2500 Suburban	--	92 - 99	31043	--	500 / 5,000	45	30	Exposed
C3500	--	88 - 00	31043	--	500 / 5,000	45	30	Exposed
Canyon	--	15 - 22	31074	D, ●	500 / 5,000	37	45	Concealed
	Excluding Z71 with front stabilizer bar	10 - 12	31221	D, ●	500 / 5,000	56	30	Concealed
	--	04 - 09	31221	D, ●	500 / 5,000	56	30	Concealed
Envoy	--	02 - 09	31055	D, ●	350 / 3,500	77	45	Exposed
Jimmy	4WD	94 - 01	31021	●	350 / 3,500	27	30	Exposed
K1500	--	88 - 99	31042	●	500 / 5,000	37	30	Concealed
K1500 Suburban	--	92 - 99	31042	●	500 / 5,000	37	30	Concealed
K2500	--	88 - 00	31042	●	500 / 5,000	37	30	Concealed
K2500 Suburban	--	92 - 99	31042	●	500 / 5,000	37	30	Concealed
K3500	--	88 - 00	31042	●	500 / 5,000	37	30	Concealed
Savana 1500	--	96 - 03	31016	--	500 / 5,000	25	35	Exposed
Savana 2500	--	96 - 03	31016	--	500 / 5,000	25	35	Exposed
Savana 3500	--	96 - 03	31016	--	500 / 5,000	25	35	Exposed
Sierra 1500	Excluding AT4, AT4X, Denali, Elevation, diesel, or Max Trailering package	22 - 25	31092	--	500 / 5,000	43	60	Concealed
	Excluding 2.7L, 3.0L, or Elevation	19 - 21	31088	●	500 / 5,000	43	30	Concealed
	--	14 - 18	31069	D	500 / 5,000	37	45	Concealed
		14 - 18	31012	D	500 / 5,000	51	45	Concealed
		07 - 13	31322	D, ●	500 / 5,000	45	30	Concealed
		99 - 06	31302	D, ●	500 / 5,000	65	60	Concealed
Sierra 1500 Classic	--	07 - 07	31302	D, ●	500 / 5,000	65	60	Concealed
Sierra 1500 HD	--	01 - 06	31108	D, ●	500 / 5,000	45	30	Concealed
Sierra 1500 HD Classic	--	07 - 07	31108	D, ●	500 / 5,000	45	30	Concealed
Sierra 1500 Limited	Excluding 2.7L, 3.0L, or Elevation	22 - 22	31088	●	500 / 5,000	43	30	Concealed
	--	19 - 19	31069	D	500 / 5,000	37	45	Concealed
		19 - 19	31012	D	500 / 5,000	51	45	Concealed

● = No drilling required
D = Minor fascia trim

* Continued while supplies last

Applications continued on the following page

Make / Model	Style	Years	Part #	Foot Notes	GTW / TW (lbs.)	Price Code	Install Time	Main Body
GMC (continued)								
Sierra 2500	--	99 - 04	31108	D, ●	500 / 5,000	45	30	Concealed
Sierra 2500 HD	--	20 - 25	31091	●	500 / 5,000	35	60	Concealed
		15 - 19	31071	●	500 / 5,000	35	30	Concealed
		11 - 14	31023	D, ●	500 / 5,000	17	30	Concealed
		07 - 10	31109	●	500 / 5,000	37	30	Concealed
		01 - 06	31108	D, ●	500 / 5,000	45	30	Concealed
Sierra 2500 HD Classic	--	07 - 07	31108	D, ●	500 / 5,000	45	30	Concealed
Sierra 3500	--	01 - 06	31108	D, ●	500 / 5,000	45	30	Concealed
Sierra 3500 Classic	--	07 - 07	31108	D, ●	500 / 5,000	45	30	Concealed
Sierra 3500 HD	--	20 - 25	31091	●	500 / 5,000	35	60	Concealed
		15 - 19	31071	●	500 / 5,000	35	30	Concealed
		11 - 14	31023	D, ●	500 / 5,000	17	30	Concealed
		07 - 10	31109	●	500 / 5,000	37	30	Concealed
Sonoma	4WD	94 - 04	31021	●	350 / 3,500	27	30	Exposed
Yukon	--	15 - 20	31073	D	500 / 5,000	35	45	Concealed
	Excluding Hybrid	07 - 14	31012	D	500 / 5,000	51	45	Concealed
	--	00 - 06	31302	D, ●	500 / 5,000	65	60	Concealed
Yukon XL	--	92 - 99	31042	●	500 / 5,000	37	30	Concealed
		15 - 20	31073	D	500 / 5,000	35	45	Concealed
Yukon XL 1500	--	00 - 06	31302	D, ●	500 / 5,000	65	60	Concealed
Yukon XL 2500	--	01 - 06	31108	D, ●	500 / 5,000	45	30	Concealed
Honda								
Pilot	--	03 - 08	33328	D, ●	350 / 3,500	65	35	Exposed
Ridgeline	--	17 - 20	31082	D	500 / 5,000	51	30	Exposed
		06 - 14	33328	D, ●	350 / 3,500	65	35	Exposed
Jeep								
Cherokee	--	84 - 01	31084	D	300 / 3,000	25	30	Exposed
Comanche	--	86 - 92	31084	D	300 / 3,000	25	30	Exposed
Gladiator	Excluding Mojave or Rubicon	20 - 24	31086	D, ●	350 / 3,500	17	45	Concealed
Grand Cherokee	Excluding SRT, SRT8, Trailhawk, and models with factory tow hooks	11 - 17	31033	D	300 / 3,000	67	35	Concealed
	--	05 - 10	31047	--	300 / 3,000	61	90	Exposed
	--	02 - 04	31048	--	350 / 3,500	77	45	Concealed
Liberty	--	03 - 07	31022		350 / 3,500	49	30	Exposed
Wagoneer	Except Grand Wagoneer	84 - 90	31084	D	300 / 3,000	25	30	Exposed
Wrangler	JL, excluding Rubicon 392	18 - 24	31086	D, ●	350 / 3,500	17	45	Concealed
	JK, excluding Hard Rock and 75th Anniversary bumpers	07 - 18	31432	D, ●	350 / 3,500	45	45	Concealed
	JK, with hard rock bumper	07 - 18	31433	●	350 / 3,500	59	30	Exposed
	--	97 - 06	31028	--	350 / 3,500	43	30	Exposed
	--	87 - 06	31408	D, ●	350 / 3,500	22	30	Exposed
Lincoln								
Mark LT	--	06 - 08	31352	D, ●	500 / 5,000	56	30	Concealed
Navigator	--	09 - 17	31068	D, ●	500 / 5,000	56	30	Exposed

● = No drilling required
D = Minor fascia trim

* Continued while supplies last

Applications continued on the following page

Make / Model	Style	Years	Part #	Foot Notes	GTW / TW (lbs.)	Price Code	Install Time	Main Body
Nissan								
Frontier	--	05 - 20	31241	●	350 / 3,500	51	35	Exposed
NV1500	--	16 - 21	31077	●	500 / 5,000	43	30	Exposed
NV2500	--	16 - 21	31077	●	500 / 5,000	43	30	Exposed
NV3500	--	16 - 21	31077	●	500 / 5,000	43	30	Exposed
Pathfinder	--	05 - 12	31241	●	350 / 3,500	51	35	Exposed
Titan	4WD	09 - 15	31061	--	500 / 5,000	67	45	Exposed
	--	04 - 08	31199	--	500 / 5,000	61	45	Exposed
Titan XD	--	16 - 17	31077	●	500 / 5,000	43	30	Exposed
Xterra	--	05 - 15	31514	●	350 / 3,500	69	35	Exposed
Ram								
1500	Excluding Rebel or diesel	19 - 25	31090	●	500 / 5,000	51	30	Concealed
	4WD	11 - 18	31374	D	500 / 5,000	39	30	Concealed
1500 Classic	4WD, excluding Warlock	19 - 24	31374	D	500 / 5,000	39	30	Concealed
2500	Excluding diesel	19 - 24	31093	--	500 / 5,000	46	90	Concealed
	4WD	11 - 18	31015	D, ●	500 / 5,000	46	30	Concealed
3500	Excluding diesel	19 - 24	31093	--	500 / 5,000	46	90	Concealed
	4WD	13 - 18	31067	D, ●	500 / 5,000	59	30	Concealed
Suzuki								
Equator	--	09 - 12	31241	●	350 / 3,500	51	35	Exposed
Toyota								
4Runner	--	14 - 21	31076	●	350 / 3,500	71	30	Exposed
	Limited	10 - 21	31054	●	350 / 3,500	69	30	Exposed
	SR5	10 - 13	31054	●	350 / 3,500	69	30	Exposed
	Trail	10 - 13	31367	●	350 / 3,500	69	30	Exposed
	--	07 - 09	31367	●	350 / 3,500	69	30	Exposed
FJ Cruiser	--	07 - 14	31367	●	350 / 3,500	69	30	Exposed
Land Cruiser	--	08 - 18	31198	●	500 / 5,000	37	30	Exposed
Sequoia	--	08 - 21	31198	●	500 / 5,000	37	30	Exposed
		01 - 07	31180	--	500 / 5,000	46	40	Exposed
Tacoma	--	16 - 23	31075	D, ●	350 / 3,500	45	30	Exposed
		05 - 15	31313	●	350 / 3,500	71	35	Exposed
		01 - 04	31013	--	500 / 5,000	43	45	Exposed
Tundra	--	07 - 21	31198	●	500 / 5,000	37	30	Exposed
		00 - 06	31180	--	500 / 5,000	46	40	Exposed

● = No drilling required
D = Minor fascia trim

* Continued while supplies last

TRAILER HITCHES & CUSTOM WIRING APPLICATION GUIDE

With over 1,000 different custom-fit hitch designs and over 400 custom wiring products, CURT has an application for virtually every vehicle on the road today. Our Application Guide makes it easy to locate the correct part for your customer's vehicle, simply by using the make, model, style, and year. For the most up-to-date fitment data, we also offer an online version at curtmfg.com.

CLASS 1 & 2 TRAILER HITCH ORDERING OPTIONS

Scan for current applications or visit curtmfg.com



Hitch only

With ball mount, pin & clip



Ordering Option	Add-On#	Example Order#
Hitch only	None	11290
Hitch with ball mount, pin & clip	3	112903

HOW TO CONFIRM VEHICLE MODEL YEAR

Each VIN (vehicle identification number) is unique and has become standard in all vehicles manufactured since 1981. Of this 17-digit number, the 10th digit represents the model year. Use the table below to find the year that corresponds with each letter or number. **Note:** A VIN will never contain the letters I (i), O (o), Q (q), U (u) or Z (z).

Example VIN tag

DATE: 06/25	GVWR 7200LB / 3266KG
FRONT GAWR: 3750LB	REAR GAWR: 3850LB
1701 KB	WITH 1745KG
P275 / 65R18	TIRES WITH
18X7.5J	RIMS 18X7.5J
AT 240 KPO/35PSI COLD	AT 240 KPO/35PSI COLD

THIS VEHICLE CONFORMS TO ALL APPLICABLE FEDERAL MOTOR VEHICLE SAFETY STANDARDS IN EFFECT ON THE DATE OF MANUFACTURE SHOWN ABOVE.

VIN: XXXXXXXXXX**S**XXXXXXX
TYPE: TRUCK

VIN-to-year chart

Code	Year	Code	Year	Code	Year	Code	Year
A	1980	R	1994	8	2008	N	2022
B	1981	S	1995	9	2009	P	2023
C	1982	T	1996	A	2010	R	2024
D	1983	V	1997	B	2011	S	2025
E	1984	W	1998	C	2012	T	2026
F	1985	X	1999	D	2013	V	2027
G	1986	Y	2000	E	2014	W	2028
H	1987	1	2001	F	2015	X	2029
J	1988	2	2002	G	2016	Y	2030
K	1989	3	2003	H	2017	1	2031
L	1990	4	2004	J	2018	2	2032
M	1991	5	2005	K	2019	3	2033
N	1992	6	2006	L	2020	4	2034
P	1993	7	2007	M	2021	5	2035

S indicates a 2025 model year

TRAILER HITCH GUIDE FOOTNOTE KEY

Trailer Hitches Application Guide Footnote Key

A	Allow additional installation time	H	Will not fit vehicles with twin tailpipes	S	May interfere w/ hands free liftgate sensors
AA	Main body concealed	HE	Hole enlargement required	T	Minor modifications required
B	Relocate or modify exhaust	I	Will not fit with full size spare	TG	Compatible with Tommy Gate lifts
BB	Main body exposed	J	No spare tire relocation	U	May required battery removal
CC	Roll pan modification required	K	OEM-style hitch	V	Under car trimming (not fascia) required
CF	Carbide black finish	L	Fixed draw bar	VT	Vertical receiver tube
D	Minor fascia trim required	M	Round tube main body	W	Only vehicles with boxed rear bumper
E	Noticeable fascia trim required	N	Continued while supplies last	X	158" WB models must remove brace 118" WB models must relocate spare tire
F	Will not fit vehicles with ground effects	P	Not with roll pan bumper	●	No drilling required
FR	Temporary bumper fascia removal	Q	Temporary bumper removal	--	
G	Add'l install w/ load level air compressors	R	Boxed due to bolt-on arms	--	

CUSTOM WIRING GUIDE FOOTNOTE KEY

Custom Wiring Application Guide Footnote Key

T1	Multiple parts available. Visit curtmfg.com	T23	CX & CXL only	T45	Excluding 2012 base model
T2	Replaces factory connector with 4-flat	T24	2-door	T46	Excluding GSR & R-Line models
T3	Replaces factory connector with 6-way	T25	Excluding Premier	T47	Titanium only
T4	Replaces factory connector with 7-way	T26	Premier only	T48	S or SE only
T5	Adds 4-flat to factory equipped 7-way	T27	LTZ only	T49	Built in USA
T6	Without LED taillights	T28	LX & Touring only	T50	Built in Mexico
T7	With LED taillights	T29	Excluding LX & Touring	T51	Excluding Canadian models
T8	With factory tow package	T30	Excluding SE & SEL	T52	With backup sensors
T9	Without factory tow package	T31	SE & SEL only	T53	US market only
T10	Hybrid only	T32	Flareside bed	T54	With onboard scale
T11	Excluding hybrid	T33	Excluding flareside bed	T55	Excluding Hybrid SE
T12	Excluding EX and Limited	T34	Built before 11/02	T56	Excluding XLE
T13	Excluding right hand drive	T35	Excluding Police Package	T57	Hybrid SE
T14	AWD models only	T36	Built after 11/02	T58	LX or S only
T15	Excluding Grand Touring	T37	US vehicles only	T59	Excluding LX or S
T16	WRX only	T38	Excluding Limited	T60	XLE or XSE only
T17	Single rear wheels	T39	Limited only	T61	Excluding EX, LX, or S
T18	SE models only	T40	Hybrid Blue only	T62	Avenir only
T19	Excluding SE models	T41	Excluding Hybrid Blue	T63	Excluding Avenir
T20	Limited 2.0L and EX 2.0L models only	T42	Excluding SX	N	Continued while supplies last
T21	Excluding LTZ	T43	V6 only	--	
T22	Excluding plug-in models	T44	Excluding WRX models	--	

APPLICATION GUIDE ELECTRICAL SYSTEM NOTES

Electrical System Notes & Abbreviations

1	2-wire system - No converter needed, 20-minute install See page 174 and 176 for suggested splice-in plugs	5	3-wire system - Use powered converter, 45-minute install
2	2-wire system - Use powered converter, 45-minute install See page 154 for suggested splice-in converter	6	3-wire system - Use HD powered converter, 45-minute install
3	2-wire system - Use multi-function converter, 45-minute install See page 154 for suggested splice-in converter	7	System requires PWM-ST converter, 45-minute install
4	3-wire system - Use non-powered converter, 20-minute install	8	System requires PWM-STT converter, 45-minute install
		9	System requires low-side switching converter, 45-minute install
		10	System type to be determined at time of install
		11	Vehicle plug may require dealer activation

PULSE WIDTH MODULATION (PWM) SYSTEM TYPES: **ST** - Stop, Tail and **STT** - Stop, Tail, Turn



TRAILER HITCHES

For 1.25" ordering options, see page 32

CUSTOM WIRING

No splicing required

CWH - For vehicles without OE tow package

ADD - Adds to OE tow package

REPL - Replacement for OE tow package

Splice-in Converters

Make / Model	Style / Notes	Years	TRAILER HITCHES							CUSTOM WIRING						Part#	Sys. Note	
			Rec. Size	Part#	Foot Note	PC	GTW / TW	WD / WDTW	INS	Years	Part#	Prod Type	Plug	FN	PC			INS
ACURA																		
CL	--	01 - 03	1.25	11290	AA	137	2.0 / 200	--	30	97 - 03	55336	CWH	4-FLAT	E8	10	56496	4	
CSX	--	06 - 11	1.25	11391	BB, V	137	2.0 / 200	--	30	06 - 11	--	--				--	10	
EL	--	97 - 00	1.25	11207	BB, ●	145	2.0 / 200	--	45	97 - 00	--	--				56496	4	
ILX	--	13 - 22	1.25	11391	BB, V	137	2.0 / 200	--	30	13 - 22	56269	CWH	4-FLAT	E20	45	56496	5	
MDX	--	22 - 25	2	13472	AA, S, ●	53	6.0 / 900	8.0 / 900	30	14 - 20	56192	CWH	4-FLAT	E13	15	56236	6	
		14 - 20	2	13146	AA, ●	49	6.0 / 900	8.0 / 900	30	07 - 13	56038	CWH	4-FLAT	E11	30	56496	5	
		07 - 13	2	13354	BB, M, I, ●	63	4.0 / 400	5.0 / 500	30	01 - 06	55336	CWH	4-FLAT	E8	10	56496	4	
		01 - 06	2	13328	AA, ●	45	3.5 / 350	5.0 / 500	30									
		19 - 25	2	13423	BB, M, ●	16	3.5 / 350	--	45	19 - 22	56509	CWH	4-FLAT	E17	45	56496	5	
RDX	--	13 - 18	1.25	12083	AA, ●	135	3.5 / 350	--	30	07 - 18	56008	CWH	4-FLAT	E12	30	56496	5	
			2	13130	AA, ●	22	4.0 / 600	--	30									
		10 - 12	2	13154	BB, M, ●	22	4.0 / 400	--	30									
		07 - 09	1.25	12004	AA, N, ●	145	3.5 / 300	--	30									
			2	13536	AA, ●	39	3.5 / 300	--	30									
SLX	--	96 - 99	2	13098	BB, ●	51	5.0 / 500	6.0 / 600	30	96 - 99	55339	CWH	4-FLAT	E9	10	56496	4	
TL	--	09 - 14	1.25	11496	M, V	125	2.0 / 200	--	45	09 - 09	--	--				56496	5	
		99 - 03	1.25	11290	AA	137	2.0 / 200	--	30	96 - 03	55336	CWH	4-FLAT	E8	10	56496	4	
TSX	SEDAN	09 - 14	1.25	11496	M, V	125	2.0 / 200	--	45	06 - 14	55502	CWH	4-FLAT	E12	10	56496	4	
	WAGON	11 - 14	1.25	11085	BB, HE, M, V, ●	133	2.0 / 200	--	45	11 - 14	--	--				--	10	
TLX	--	21 - 25	1.25	11670	BB, HE, V	135	2.0 / 200	--	60	21 - 24	56528	CWH	4-FLAT	E28	60	56496	5	
		15 - 20	1.25	11535	BB, M, ●	145	2.0 / 200	--	45	15 - 20	56525	CWH	4-FLAT	E26	45	56496	5	

ALFA ROMEO

STELVIO	EXCL. QUADRIFOGLIO	18 - 24	2	13391	BB, M, ●	65	4.0 / 600	--	45	--	--	--				--	--
---------	--------------------	---------	---	-------	----------	----	-----------	----	----	----	----	----	--	--	--	----	----

AUDI

A3	SEDAN	15 - 20	1.25	11399	AA, ●	157	2.0 / 200	--	30	15 - 22	--	--				56236	7
	HATCHBACK	06 - 13	1.25	11192	AA, E, FR, Q	175	2.0 / 200	--	150	06 - 13	--	--				--	10
A3 QUATTRO	SEDAN	15 - 20	1.25	11399	AA, ●	157	2.0 / 200	--	30	15 - 16	--	--				56496	7
A4	SEDAN, EXCL. S LINE	17 - 20	1.25	11448	BB, ●	137	2.0 / 200	--	45	02 - 22	--	--				56236	10
	SEDAN	09 - 16	1.25	11186	AA, D, ●	145	2.0 / 200	--	30								
		02 - 08	1.25	11164	AA	178	2.0 / 200	--	30								
	WAGON	02 - 06	1.25	11164	AA	178	2.0 / 200	--	30	02 - 06	--	--				56236	10
A4 ALLROAD	--	17 - 22	1.25	11448	BB, ●	137	2.0 / 200	--	45	--	--	--				--	--
A4 QUATTRO	SEDAN, EXCL. S LINE	17 - 24	1.25	11448	BB, ●	137	2.0 / 200	--	45	02 - 12	--	--				56236	10
	SEDAN	09 - 16	1.25	11186	AA, D, ●	145	2.0 / 200	--	30								
		02 - 08	1.25	11164	AA	178	2.0 / 200	--	30								
	WAGON	09 - 12	1.25	11195	BB, M, V, ●	171	2.0 / 200	--	45	02 - 11	--	--				56236	10
		02 - 06	1.25	11164	AA	178	2.0 / 200	--	30								
A5 QUATTRO	COUPE	18 - 22	1.25	11448	BB, ●	137	2.0 / 200	--	45	08 - 17	--	--				56236	6
	COUPE, SINGLE MUFFLER	08 - 16	1.25	11037	BB, M, N, V, ●	161	2.0 / 200	--	30								
A5 SPORTBACK	--	18 - 22	1.25	11448	BB, ●	137	2.0 / 200	--	45	18 - 18	--	--				56236	10
A6	SEDAN	12 - 16	1.25	11423	AA, D, ●	187	2.0 / 200	--	45	15 - 22	--	--				56236	5
A6 QUATTRO	SEDAN	12 - 16	1.25	11423	AA, D, ●	187	2.0 / 200	--	45	15 - 16	--	--				56496	5
A7 QUATTRO	EXCL. DIESEL MODELS	12 - 16	1.25	11197	BB, N, ●	165	2.0 / 200	--	30	12 - 12	--	--				56496	5
ALLROAD	--	13 - 16	1.25	11195	BB, M, V, ●	171	2.0 / 200	--	45	13 - 13	--	--				56496	2
Q3	--	15 - 18	2	13238	AA, D, HE, M, V, ●	46	3.5 / 525	--	45	15 - 23	--	--				56236	2
		15 - 16	2	13209	AA, N, V, ●	61	3.5 / 525	--	45								
Q3 QUATTRO	--	15 - 18	2	13238	AA, D, HE, M, V, ●	46	3.5 / 525	--	45	15 - 18	--	--				56496	2
Q4 E-TRON	WITHOUT FACTORY RECEIVER	23 - 24	2	13492	AA, FR, Q, ●	49	3.0 / 300	--	90	23 - 24	--	--				--	10

TRAILER HITCH APPLICATION GUIDE FOOTNOTE KEY For the most up-to-date application information, please visit curtmfg.com

A Allow additional installation time	CC Roll pan mods required	F Will not fit vehicles with ground effects	HE Hole enlargement required	L Fixed draw bar	Q Temporary bumper removal	TG Compatible with Tommy Gate lifts	VT Vertical receiver tube
AA Main body concealed	CF Carbide black finish	FR Temporary bumper fascia removal	I Will not fit with full size spare	M Round tube main body	R Boxed due to bolt-on arms	U May require battery removal	W Only with boxed rear bumper
B Relocate or modify exhaust	D Minor fascia trim required	G Add'l install w/ load level air compressors	J No spare tire relocation	N Continued while supplies last	S May interfere hands free liftgate sensor	V Under-car trim (not fascia) req'd	● No drilling required
BB Main body exposed	E Noticeable fascia trim required	H Will not fit vehicles with twin tailpipes	K OEM-style hitch	P Not with roll pan bumper	T Modifications required (minor)	X 158" WB models require brace removal, 118" WB models require spare tire reloc.	



TRAILER HITCHES

For 1.25" ordering options, see page 32

CUSTOM WIRING

No splicing required

CWH - For vehicles without OE tow package

ADD - Adds to OE tow package

REPL - Replacement for OE tow package

Splice-in Converters

Make / Model	Style / Notes	Years	Rec. Size	Part#	Foot Note	PC	GTW / TW	WD / WDTW	INS	CUSTOM WIRING						Part#	Sys. Note	
										Years	Part#	Prod Type	Plug	FN	PC			INS
AUDI (CONTINUED)																		
Q4 E-TRON SPORTBACK	WITHOUT FACTORY RECEIVER	23 - 24	2	13492	AA, FR, Q, ●	49	3.0 / 300	--	90	23 - 24	--	--				--	10	
Q5	--	18 - 24	2	13499	AA, FR, Q, ●	45	5.0 / 750	--	90	18 - 23	--	--				56236	7	
		11 - 17	2	13612	AA, D, FR, Q, ●	45	5.0 / 750	--	60	13 - 17	56404	CWH	4-FLAT		E28	45	56236	7
Q7	EXCL. HYBRID	09 - 17	2	13136	BB, FR, M	45	5.0 / 750	--	45	09 - 12	--	--				56236	7	
		17 - 25	2	13277	AA, D, FR, Q, ●	46	7.0 / 700	--	60	17 - 25	--	--				56236	10	
		07 - 15	2	13220	A, D, ●	63	6.0 / 600	--	90	10 - 15	--	--				56236	6	
S4	EXCL. CONVERTIBLE	04 - 08	1.25	11164	AA	178	2.0 / 200	--	30	03 - 08	--	--				--	10	
S5	COUPE	18 - 22	1.25	11448	BB, ●	137	2.0 / 200	--	45	11 - 17	--	--				56236	6	
S5 SPORTBACK	--	18 - 22	1.25	11448	BB, ●	137	2.0 / 200	--	45	--	--	--				--	--	
SQ5	--	18 - 24	2	13499	AA, FR, Q, ●	45	5.0 / 750	--	90	14 - 17	56404	CWH	4-FLAT		E28	45	56236	7
BMW																		
128i	--	08 - 11	1.25	11184	AA, V, ●	153	2.0 / 200	--	60	08 - 09	--	--				56496	5	
135i	--	08 - 11	1.25	11184	AA, V, ●	153	2.0 / 200	--	60	08 - 09	--	--				56496	5	
228i	--	14 - 16	1.25	11367	AA, FR, Q, ●	135	2.0 / 200	--	45	--	--	--				--	--	
228i XDRIVE	--	15 - 16	1.25	11367	AA, FR, Q, ●	135	2.0 / 200	--	45	--	--	--				--	--	
230i	--	17 - 21	1.25	11367	AA, FR, Q, ●	135	2.0 / 200	--	45	--	--	--				--	--	
230i XDRIVE	--	17 - 21	1.25	11367	AA, FR, Q, ●	135	2.0 / 200	--	45	--	--	--				--	--	
320i	--	13 - 18	1.25	11367	AA, FR, Q, ●	135	2.0 / 200	--	45	01 - 05	--	--				56496	5	
320i XDRIVE	--	13 - 18	1.25	11367	AA, FR, Q, ●	135	2.0 / 200	--	45	--	--	--				--	--	
323CI	COUPE	00 - 00	1.25	11174	AA	189	2.0 / 200	--	45	00 - 00	--	--				56496	5	
323i	SEDAN	00 - 00	1.25	11174	AA	189	2.0 / 200	--	45	98 - 00	--	--				56496	5	
	WAGON	00 - 00	1.25	11174	AA	189	2.0 / 200	--	45	98 - 00	--	--				56496	5	
325CI	COUPE	01 - 05	1.25	11174	AA	189	2.0 / 200	--	45	01 - 05	--	--				56496	5	
325i	SEDAN	06 - 06	1.25	11033	AA, V	171	2.0 / 200	--	30	06 - 06	--	--				--	10	
		01 - 05	1.25	11174	AA	189	2.0 / 200	--	45	01 - 05	--	--				56496	5	
	WAGON	01 - 05	1.25	11174	AA	189	2.0 / 200	--	45	01 - 05	--	--				56496	5	
325XI	SEDAN	01 - 05	1.25	11174	AA	189	2.0 / 200	--	45	01 - 05	--	--				56496	5	
	WAGON	01 - 05	1.25	11174	AA	189	2.0 / 200	--	45	01 - 05	--	--				56496	5	
328D	--	14 - 18	1.25	11367	AA, FR, Q, ●	135	2.0 / 200	--	45	--	--	--				--	--	
328D XDRIVE	--	14 - 18	1.25	11367	AA, FR, Q, ●	135	2.0 / 200	--	45	--	--	--				--	--	
328i	SEDAN	12 - 16	1.25	11367	AA, FR, Q, ●	135	2.0 / 200	--	45	12 - 13	--	--				--	10	
		00 - 00	1.25	11174	AA	189	2.0 / 200	--	45	00 - 00	--	--				56496	5	
	WAGON	11 - 12	1.25	11367	AA, FR, Q, ●	135	2.0 / 200	--	45	--	--	--				--	--	
328i XDRIVE	SEDAN	12 - 13	1.25	11367	AA, FR, Q, ●	135	2.0 / 200	--	45	13 - 13	--	--				56496	5	
	WAGON	14 - 16	1.25	11367	AA, FR, Q, ●	135	2.0 / 200	--	45	--	--	--				--	--	
		11 - 12	1.25	11367	AA, FR, Q, ●	135	2.0 / 200	--	45	--	--	--				--	--	
328XI	SEDAN, SINGLE MUFFLER	07 - 08	1.25	11033	AA, V	171	2.0 / 200	--	30	07 - 08	--	--				56496	5	
330CI	COUPE	01 - 05	1.25	11174	AA	189	2.0 / 200	--	45	01 - 05	--	--				56496	5	
330i	--	17 - 18	1.25	11367	AA, FR, Q, ●	135	2.0 / 200	--	45	--	--	--				--	--	
		01 - 05	1.25	11174	AA	189	2.0 / 200	--	45	01 - 05	--	--				56496	5	
330XI	--	01 - 05	1.25	11174	AA	189	2.0 / 200	--	45	01 - 05	--	--				56496	5	
335i GT XDRIVE	--	14 - 16	1.25	11367	AA, FR, Q, ●	135	2.0 / 200	--	45	--	--	--				--	--	
335i XDRIVE	SEDAN	13 - 15	1.25	11367	AA, FR, Q, ●	135	2.0 / 200	--	45	--	--	--				--	--	
335XI	SEDAN, SINGLE MUFFLER, GAS MODELS	07 - 08	1.25	11033	AA, V	171	2.0 / 200	--	30	07 - 08	--	--				56496	5	
340i	--	16 - 18	1.25	11367	AA, FR, Q, ●	135	2.0 / 200	--	45	--	--	--				--	--	
340i XDRIVE	--	16 - 18	1.25	11367	AA, FR, Q, ●	135	2.0 / 200	--	45	--	--	--				--	--	
428i	COUPE	14 - 18	1.25	11367	AA, FR, Q, ●	135	2.0 / 200	--	45	--	--	--				--	--	
428i GRAN COUPE	--	15 - 16	1.25	11367	AA, FR, Q, ●	135	2.0 / 200	--	45	--	--	--				--	--	
428i XDRIVE	COUPE	14 - 16	1.25	11367	AA, FR, Q, ●	135	2.0 / 200	--	45	--	--	--				--	--	
	CONVERTIBLE	14 - 15	1.25	11367	AA, FR, Q, ●	135	2.0 / 200	--	45	--	--	--				--	--	
428i XDRIVE GRAN COUPE	--	15 - 15	1.25	11367	AA, FR, Q, ●	135	2.0 / 200	--	45	--	--	--				--	--	

CUSTOM WIRING APPLICATION GUIDE FOOTNOTE KEY						For the most up-to-date application information, please visit curtmfg.com					
T1 Multiple parts available. Visit curtmfg.com	T5 Adds 4-flat to factory equipped 7-way	T9 Without factory tow package	T13 Excluding right hand drive	T17 Single rear wheels	T21 Excluding LTZ						
T2 Replaces factory connector with 4-flat	T6 Without LED taillights	T10 Hybrid only	T14 All wheel drive (AWD) models only	T18 SE models only	T22 Excluding plug-in models						
T3 Replaces factory connector with 6-way	T7 With LED taillights	T11 Excluding hybrid	T15 Excluding Grand Touring	T19 Excluding SE models	See page 33 for T23 - T63 footnote key comments						
T4 Replaces factory connector with 7-way	T8 With factory tow package	T12 Excluding EX and Limited	T16 WRX only	T20 Limited 2.0L and EX 2.0L models only	See page 33 for 'Electrical System Notes'						



TRAILER HITCHES

For 1.25" ordering options, see page 32

CUSTOM WIRING

No splicing required

CWH - For vehicles without OE tow package

ADD - Adds to OE tow package

REPL - Replacement for OE tow package

Splice-in Converters

Make / Model	Style / Notes	Years	Rec. Size	Part#	Foot Note	PC	GTW / TW	WD / WDTW	INS	CUSTOM WIRING						Splice-in Converters	
										Years	Part#	Prod Type	Plug	FN	PC	INS	Part#
BMW (CONTINUED)																	
430I	--	17 - 20	1.25	11367	AA, FR, Q, ●	135	2.0 / 200	--	45	--	--	--				--	--
430I GRAN COUPE	--	17 - 20	1.25	11367	AA, FR, Q, ●	135	2.0 / 200	--	45	--	--	--				--	--
430I XDRIVE	--	17 - 20	1.25	11367	AA, FR, Q, ●	135	2.0 / 200	--	45	--	--	--				--	--
430I XDRIVE GRAN COUPE	--	17 - 20	1.25	11367	AA, FR, Q, ●	135	2.0 / 200	--	45	--	--	--				--	--
435I	COUPE	14 - 16	1.25	11367	AA, FR, Q, ●	135	2.0 / 200	--	45	--	--	--				--	--
435I GRAN COUPE	--	15 - 16	1.25	11367	AA, FR, Q, ●	135	2.0 / 200	--	45	--	--	--				--	--
435I XDRIVE	COUPE	14 - 16	1.25	11367	AA, FR, Q, ●	135	2.0 / 200	--	45	--	--	--				--	--
435I XDRIVE GRAN COUPE	--	15 - 16	1.25	11367	AA, FR, Q, ●	135	2.0 / 200	--	45	--	--	--				--	--
440I	--	17 - 20	1.25	11367	AA, FR, Q, ●	135	2.0 / 200	--	45	--	--	--				--	--
440I GRAN COUPE	--	17 - 20	1.25	11367	AA, FR, Q, ●	135	2.0 / 200	--	45	--	--	--				--	--
440I XDRIVE	--	17 - 20	1.25	11367	AA, FR, Q, ●	135	2.0 / 200	--	45	--	--	--				--	--
440I XDRIVE GRAN COUPE	--	17 - 20	1.25	11367	AA, FR, Q, ●	135	2.0 / 200	--	45	--	--	--				--	--
525I	SEDAN	04 - 07	1.25	11498	AA	179	2.0 / 200	--	60	04 - 07	--	--				56496	5
525XI	--	06 - 07	1.25	11498	AA	179	2.0 / 200	--	60	06 - 07	--	--				56496	5
528I	SEDAN	08 - 10	1.25	11498	AA	179	2.0 / 200	--	60	08 - 10	--	--				56496	5
528I XDRIVE	--	09 - 10	1.25	11498	AA	179	2.0 / 200	--	60	09 - 10	--	--				56496	5
528XI	--	08 - 08	1.25	11498	AA	179	2.0 / 200	--	60	08 - 08	--	--				56496	5
530I	SEDAN, SINGLE MUFFLER	17 - 23	1.25	11478	AA, V, ●	145	2.0 / 200	--	60	01 - 07	--	--				56496	5
		04 - 07	1.25	11498	AA	179	2.0 / 200	--	60								
530I XDRIVE	--	17 - 23	1.25	11478	AA, V, ●	145	2.0 / 200	--	60	--	--	--				--	--
530XI	SEDAN	06 - 07	1.25	11498	AA	179	2.0 / 200	--	60	06 - 07	--	--				56496	5
535I	SEDAN, EXCL. GT	11 - 16	1.25	11381	AA, V	145	2.0 / 200	--	60	11 - 16	--	--				56236	10
		08 - 10	1.25	11498	AA	179	2.0 / 200	--	60	08 - 10	--	--				56496	5
535I XDRIVE	EXCL. GT	11 - 16	1.25	11381	AA, V	145	2.0 / 200	--	60	11 - 16	--	--				56236	10
535XI	SEDAN	08 - 08	1.25	11498	AA	179	2.0 / 200	--	60	08 - 08	--	--				56496	5
540I	SEDAN	17 - 23	1.25	11478	AA, V, ●	145	2.0 / 200	--	60	--	--	--				--	--
540I XDRIVE	--	17 - 23	1.25	11478	AA, V, ●	145	2.0 / 200	--	60	--	--	--				--	--
545I	--	04 - 05	1.25	11498	AA	179	2.0 / 200	--	60	04 - 05	--	--				56496	5
550I	--	11 - 16	1.25	11381	AA, V	145	2.0 / 200	--	60	11 - 14	--	--				56236	10
		07 - 10	1.25	11498	AA	179	2.0 / 200	--	60	07 - 10	--	--				56496	5
550I XDRIVE	--	11 - 14	1.25	11381	AA, V	145	2.0 / 200	--	60	11 - 14	--	--				56236	10
IX	--	22 - 25	2	13532	AA, D, ●	57	0.0 / 150	--	90	--	--	--				--	--
M5	--	06 - 10	1.25	11498	AA	179	2.0 / 200	--	60	06 - 10	--	--				--	10
M240I	--	17 - 20	1.25	11367	AA, FR, Q, ●	135	2.0 / 200	--	45	--	--	--				--	--
M240I XDRIVE	--	17 - 20	1.25	11367	AA, FR, Q, ●	135	2.0 / 200	--	45	--	--	--				--	--
X1	--	16 - 22	2	13303	AA, HE	35	3.5 / 525	--	40	13 - 13	--	--				56496	5
	WITH PANORAMIC SUNROOF ONLY	13 - 15	2	13140	AA, ●	45	2.5 / 250	--	40								
X2	--	18 - 23	1.25	11530	AA, FR, HE, Q, ●	169	2.0 / 200	--	90	18 - 23	--	--				56236	10
X3	EXCL. M40I	18 - 25	2	13387	AA, FR, N, Q, V, ●	51	5.0 / 750	--	90	18 - 21	--	--				56236	2
	--	11 - 25	2	13578	AA, FR, Q, V, ●	47	5.0 / 750	--	90	11 - 17	--	--				56496	5
	--	11 - 17	2	13316	AA, FR, Q, V, ●	43	3.5 / 350	4.0 / 400	90								
	--	04 - 10	2	13573	AA, D, FR, Q	25	3.5 / 350	4.0 / 400	180								
X4	--	19 - 24	2	13578	AA, FR, Q, V, ●	47	5.0 / 750	--	90	--	--	--				--	--
	--	15 - 18	2	13316	AA, FR, Q, V, ●	43	3.5 / 350	4.0 / 400	90								

TRAILER HITCH APPLICATION GUIDE FOOTNOTE KEY

For the most up-to-date application information, please visit curtmfg.com

A Allow additional installation time	CC Roll pan mods required	F Will not fit vehicles with ground effects	HE Hole enlargement required	L Fixed draw bar	Q Temporary bumper removal	TG Compatible with Tommy Gate lifts	VT Vertical receiver tube
AA Main body concealed	CF Carbide black finish	FR Temporary bumper fascia removal	I Will not fit with full size spare	M Round tube main body	R Boxed due to bolt-on arms	U May require battery removal	W Only with boxed rear bumper
B Relocate or modify exhaust	D Minor fascia trim required	G Add'l install w/ load level air compressors	J No spare tire relocation	N Continued while supplies last	S May interfere hands free liftgate sensor	V Under-car trim (not fascia) req'd	● No drilling required
BB Main body exposed	E Noticeable fascia trim required	H Will not fit vehicles with twin tailpipes	K OEM-style hitch	P Not with roll pan bumper	T Modifications required (minor)	X 158" WB models require brace removal, 118" WB models require spare tire reloc.	



TRAILER HITCHES

For 1.25" ordering options, see page 32

CUSTOM WIRING

No splicing required

CWH - For vehicles without OE tow package

ADD - Adds to OE tow package

REPL - Replacement for OE tow package

Splice-in Converters

Make / Model	Style / Notes	Years	TRAILER HITCHES							CUSTOM WIRING							Part#	Sys. Note
			Rec. Size	Part#	Foot Note	PC	GTW / TW	WD / WDTW	INS	Years	Part#	Prod Type	Plug	FN	PC	INS		
BMW (CONTINUED)																		
X5	EXCL. M	19 - 25	2	13451	AA, FR, Q, V, ●	65	7.0 / 700	7.0 / 700	120	15 - 18	--	--				56236	2	
	--	07 - 18	2	13077	A, E, FR, M, ●	69	6.0 / 600	6.0 / 600	90	04 - 09	--	--				56236	10	
			00 - 06	2	13162	BB, D, FR, Q	35	6.0 / 600	6.0 / 600	60								
X6	--	14 - 19	2	13077	A, E, FR, M, ●	69	6.0 / 600	6.0 / 600	90	08 - 19	--	--				--	10	
		08 - 13	2	13114	AA, D, FR, Q, ●	69	6.0 / 600	--	90									
BUICK																		
ALLURE	--	05 - 09	1.25	12239	AA	159	3.5 / 350	--	45	05 - 09	--	--				--	1	
CASCADA	--	16 - 19	1.25	11441	●	178	2.0 / 200	--	30	--	--	--				--	--	
CENTURY	SEDAN	97 - 05	1.25	12239	AA	159	3.5 / 350	--	45	97 - 05	--	--				--	1	
		78 - 81	1.25	12005	BB, HE, ●	177	3.5 / 350	--	45	78 - 81	--	--				56496	4	
	WAGON	78 - 81	1.25	12005	BB, HE, ●	177	3.5 / 350	--	45	78 - 81	--	--				--	1	
ELECTRA	RWD	77 - 84	1.25	12009	BB	175	3.5 / 350	--	30	77 - 84	--	--				--	10	
ENCLAVE	--	25 - 25	2	13614	AA, FR, Q, ●	39	5.0 / 500	5.0 / 500	120	25 - 25	56538	CWH	4-FLAT	E10	20	--	1	
		18 - 24	2	13433	AA, FR, Q, ●	39	5.0 / 750	5.0 / 750	40		56537	CWH	7-WAY	E18	20	--	--	
		08 - 17	2	13424	AA, ●	25	5.0 / 500	6.0 / 600	30	18 - 24	56393	CWH	7-WAY	E13	20	--	--	
											56394	CWH	4-FLAT	E6	20	--	--	
		13 - 17							56245	REPL	4-FLAT	E11	20	56496	2			
		08 - 12							56027	CWH	4-FLAT	E8	10	--	1			
ENCORE	--	13 - 22	1.25	11527	HE, M, V	155	2.0 / 200	--	30	17 - 22	56363	CWH	4-FLAT	E23	45	56496	5	
										13 - 16	56216	CWH	4-FLAT	E20	45	56496	5	
ENCORE GX	EXCL. HANDS FREE LIFTGATE	20 - 25	1.25	11612	AA, D, FR, Q, ●	149	2.0 / 200	--	90	20 - 24	56456	CWH	4-FLAT	T7	E25	45	56496	5
			2	13584	AA, D, FR, Q, ●	46	2.0 / 200	--	50		56488	CWH	4-FLAT	T6	E25	45	56496	5
ENVISION	--	21 - 24	2	13522	AA, M, ●	29	2.0 / 200	--	30	21 - 24	56325	CWH	4-FLAT	E4	10	--	--	
		21 - 22	2	13479	BB, M, ●	22	2.0 / 200	--	30	17 - 20	56364	CWH	4-FLAT	E8	10	56496	5	
		19 - 20	2	13405	AA, ●	29	3.5 / 525	--	30									
		16 - 18	2	13292	AA, ●	35	3.5 / 525	--	30									
ENVISTA	--	24 - 25	2	13585	BB, M, ●	45	2.0 / 200	--	30	24 - 24	56522	CWH	4-FLAT	T62	E28	45	56236	5
											56542	CWH	4-FLAT	T63	E28	45	56236	5
ESTATE WAGON	--	77 - 89	1.25	12041	AA	165	3.5 / 350	--	40	77 - 89	--	--				--	1	
LACROSSE	--	10 - 16	1.25	12115	BB, D, HE, R, ●	163	3.5 / 350	--	30	10 - 16	56098	CWH	4-FLAT	E20	45	56496	5	
		05 - 09	1.25	12239	AA	159	3.5 / 350	--	45	05 - 09	56340	CWH	4-FLAT	T23	E10	10	--	1
LESABRE	SEDAN	00 - 05	1.25	12044	BB, V	157	3.5 / 350	--	30	00 - 05	--	--				--	1	
		77 - 85	1.25	12009	BB	175	3.5 / 350	--	30	77 - 85	--	--				--	10	
	WAGON	85 - 90	1.25	12041	AA	165	3.5 / 350	--	40	85 - 90	--	--				--	10	
LUCERNE	--	10 - 11	1.25	12022	AA, ●	133	3.5 / 350	--	30	06 - 11	56047	CWH	4-FLAT	E7	10	--	1	
		06 - 09	1.25	12044	BB, V	157	3.5 / 350	--	30									
PARK AVENUE	--	97 - 05	1.25	12157	AA	183	3.5 / 350	--	45	97 - 05	--	--				56496	5	
		77 - 84	1.25	12009	BB	175	3.5 / 350	--	30	77 - 84	--	--				--	10	
REGAL	--	11 - 17	1.25	12115	BB, D, HE, R, ●	163	3.5 / 350	--	30	14 - 17	--	--				56496	5	
		78 - 87	1.25	12005	BB, HE, ●	177	3.5 / 350	--	45	11 - 13	--	--				--	1	
REGAL SPORTBACK	EXCL. AWD	18 - 20	1.25	12185	BB, V, ●	129	3.5 / 350	--	30	18 - 20	56389	CWH	4-FLAT	E28	45	56496	2	
REGAL TOURX	--	18 - 20	1.25	12173	AA, ●	161	3.5 / 350	--	30	18 - 20	56389	CWH	4-FLAT	E28	45	56496	2	
RENDEZVOUS	--	02 - 07	2	13469	BB	39	3.5 / 350	--	30	02 - 07	55383	CWH	4-FLAT	E12	20	--	1	
ROADMASTER	SEDAN	92 - 96	1.25	12009	BB	175	3.5 / 350	--	30	92 - 96	55347	CWH	4-FLAT	N	E6	10	--	1
	WAGON	91 - 96	1.25	12041	AA	165	3.5 / 350	--	40	91 - 96	--	--				--	1	
TERRAZA	--	05 - 07	2	13336	●	43	4.0 / 400	6.0 / 600	30	05 - 07	56077	CWH	4-FLAT	E5	15	--	1	
			2	13344	AA	46	4.0 / 400	6.0 / 600	30									
VERANO	EXCL. DUAL EXHAUST	12 - 17	1.25	11282	AA, V, ●	135	2.0 / 200	--	30	12 - 17	56288	CWH	4-FLAT	E19	45	56496	5	

CUSTOM WIRING APPLICATION GUIDE FOOTNOTE KEY						For the most up-to-date application information, please visit curtmfg.com					
T1 Multiple parts available. Visit curtmfg.com	T5 Adds 4-flat to factory equipped 7-way	T9 Without factory tow package	T13 Excluding right hand drive	T17 Single rear wheels	T21 Excluding LTZ						
T2 Replaces factory connector with 4-flat	T6 Without LED taillights	T10 Hybrid only	T14 All wheel drive (AWD) models only	T18 SE models only	T22 Excluding plug-in models						
T3 Replaces factory connector with 6-way	T7 With LED taillights	T11 Excluding hybrid	T15 Excluding Grand Touring	T19 Excluding SE models	See page 33 for T23 - T63 footnote key comments						
T4 Replaces factory connector with 7-way	T8 With factory tow package	T12 Excluding EX and Limited	T16 WRX only	T20 Limited 2.0L and EX 2.0L models only	See page 33 for 'Electrical System Notes'						



TRAILER HITCHES

For 1.25" ordering options, see page 32

CUSTOM WIRING

No splicing required

CWH - For vehicles without OE tow package

ADD - Adds to OE tow package

REPL - Replacement for OE tow package

Splice-in Converters

Make / Model	Style / Notes	Years	TRAILER HITCHES							CUSTOM WIRING														
			Rec. Size	Part#	Foot Note	PC	GTW / TW	WD / WDTW	INS	Years	Part#	Prod Type	Plug	FN	PC	INS	Part#	Sys. Note						
CADILLAC																								
ATS	EXCL. 'V' MODELS	13 - 19	1.25	11311	BB, D, V, ●	145	2.0 / 200	--	30	13 - 19	56180	CWH	4-FLAT	E18	45	56496	2							
CTS	SEDAN	14 - 19	1.25	11900	AA, D, FR, Q, ●	141	2.0 / 200	--	45	14 - 19	56207	CWH	4-FLAT	E16	45	56496	2							
		03 - 13	1.25	11307	BB	147	2.0 / 200	--	45	08 - 13	56044	CWH	4-FLAT	E15	20	56496	2							
DEVILLE	--	00 - 05	1.25	12058	●	145	3.5 / 350	--	45	97 - 05	--	--				56496	2							
										06 - 11	1.25	12058	●	145	3.5 / 350	--	45	06 - 09	--	--				56496
ESCALADE	--	03 - 06	2	13422	BB, K, M, ●	45	6.0 / 600	10 / 1000	30	00 - 02	--	--				56496	2							
			2	15324	BB, CF, ●	71	16 / 2400	17 / 2400	30	99 - 00	55319	CWH	4-FLAT	E5	5	--	1							
		02 - 02	2	13402	●	43	6.0 / 600	10 / 1000	30															
			2	14080	BB, ●	65	10 / 1000	12 / 1200	30															
		99 - 00	2	13029	BB, HE, ●	39	6.0 / 600	10 / 1000	30															
			2	13121	M, ●	46	5.0 / 500	6.0 / 600	30															
ESCALADE ESV	--	03 - 06	2	13422	BB, K, M, ●	45	6.0 / 600	10 / 1000	30	--	--	--				--	--							
			2	15324	BB, CF, ●	71	16 / 2400	17 / 2400	30															
ESCALADE EXT	--	03 - 06	2	13422	BB, K, M, ●	45	6.0 / 600	10 / 1000	30	--	--	--				--	--							
			2	15324	BB, CF, ●	71	16 / 2400	17 / 2400	30															
LYRIQ	--	23 - 24	2	13617	BB, HE, V, ●	55	3.5 / 350	--	60	23 - 24	56427	CWH	4-FLAT	E5	5	--	10							
SRX	--	10 - 16	1.25	12070	AA, ●	137	3.5 / 350	--	30	10 - 16	56096	CWH	4-FLAT	E3	5	--	1							
			2	13002	AA, ●	35	5.0 / 500	6.0 / 600	30	04 - 09	--	--				56496	5							
		04 - 09	2	13050	M, T, ●	71	3.5 / 350	5.0 / 500	120															
STS	--	05 - 11	1.25	11307	BB	147	2.0 / 200	--	45	05 - 09	--	--				56496	2							
XTS	--	13 - 19	1.25	12115	BB, D, HE, R, ●	163	3.5 / 350	--	30	18 - 19	--	--				56236	10							
										13 - 17	--	--				56496	5							
XT4	--	19 - 25	2	13415	AA, FR, Q, ●	22	4.0 / 400	--	60	19 - 24	56427	CWH	4-FLAT	E5	5	--	10							
XT5	EXCL. PLATINUM	17 - 25	2	13285	BB, ●	43	5.0 / 750	6.0 / 750	30	17 - 25	56325	CWH	4-FLAT	E4	10	--	1							
											56326	CWH	7-WAY	E18	10	--	1							
XT6	--	20 - 25	2	13482	AA, FR, Q, ●	49.0	4.5 / 675	--	90	20 - 25	56325	CWH	4-FLAT	E4	10	--	1							
											56326	CWH	7-WAY	E18	10	--	1							
CHEVROLET																								
ASTRO	16" SPARE REQUIRES RELOCATION	85 - 05	2	13035	AA, R, ●	49	4.0 / 400	6.0 / 600	45	95 - 05	55411	CWH	4-FLAT	E2	15	--	1							
AVALANCHE	--	03 - 06	2	13422	BB, K, M, ●	45	6.0 / 600	10 / 1000	30	--	--	--				--	--							
			2	15324	BB, CF, ●	71	16 / 2400	17 / 2400	30															
		02 - 02	2	13402	●	43	6.0 / 600	10 / 1000	30															
AVE05	HATCHBACK	04 - 11	1.25	11306	AA	117	2.0 / 200	--	60	04 - 11	--					56496	4							
BLAZER	EXCL. PREMIER	19 - 25	2	13418	AA, ●	33	5.0 / 750	6.0 / 750	30	19 - 25	56325	CWH	4-FLAT	E4	10	--	--							
											56326	CWH	7-WAY	T14	E18	10	--	1						
	FULL SIZE	92 - 94	2	13029	BB, HE, ●	39	6.0 / 600	10 / 1000	30	92 - 94	55319	CWH	4-FLAT	E5	5	--	1							
											13121	M, ●	46	5.0 / 500	6.0 / 600	30	85 - 91	55312	CWH	4-FLAT	E5	5	--	1
											14029	BB, HE, ●	63	10 / 1000	12 / 1200	30	73 - 84	55311	CWH	4-FLAT	E5	5	--	1
	DOWN SIZE	95 - 04	2	13020	●	37	5.0 / 500	6.0 / 600	30	95 - 02	55411	CWH	4-FLAT	E2	15	--	1							
											13300	M, ●	43	4.0 / 400	6.0 / 600	30								
	83 - 94	2	13083	●	65	5.0 / 500	6.0 / 600	30																
BLAZER EV	--	24 - 24	2	13589	AA, D, HE, ●	35	3.5 / 350	--	60	24 - 24	56427	CWH	4-FLAT	E5	5	--	10							
BOLT EV	--	17 - 23	1.25	11457	AA, D, ●	147	1.0 / 100	--	30	--	--	--				--	--							
BOLT EUV	--	22 - 23	2	13495	AA, D, FR, Q, ●	33	2.0 / 300	--	60	22 - 23	56521	CWH	4-FLAT	E28	60	56236	5							
C10	WITH 10" STEP BUMPER	75 - 86	2	13099	J, R	69	6.0 / 600	10 / 1000	60	85 - 87	55312	CWH	4-FLAT	E5	5	--	1							
	EXCL. 10" STEP BUMPER	75 - 86	2	13028	AA	45	6.0 / 600	10 / 1000	60	75 - 84	55311	CWH	4-FLAT	E5	5	--	1							
											14082	AA	75	10 / 1000	12 / 1200	60								

TRAILER HITCH APPLICATION GUIDE FOOTNOTE KEY

For the most up-to-date application information, please visit curtmfg.com

A Allow additional installation time	CC Roll pan mods required	F Will not fit vehicles with ground effects	HE Hole enlargement required	L Fixed draw bar	Q Temporary bumper removal	TG Compatible with Tommy Gate lifts	VT Vertical receiver tube
AA Main body concealed	CF Carbide black finish	FR Temporary bumper fascia removal	I Will not fit with full size spare	M Round tube main body	R Boxed due to bolt-on arms	U May require battery removal	W Only with boxed rear bumper
B Relocate or modify exhaust	D Minor fascia trim required	G Add'l install w/ load level air compressors	J No spare tire relocation	N Continued while supplies last	S May interfere hands free liftgate sensor	V Under-car trim (not fascia) req'd	● No drilling required
BB Main body exposed	E Noticeable fascia trim required	H Will not fit vehicles with twin tailpipes	K OEM-style hitch	P Not with roll pan bumper	T Modifications required (minor)	X 158" WB models require brace removal, 118" WB models require spare tire reloc.	



TRAILER HITCHES

For 1.25" ordering options, see page 32

CUSTOM WIRING

No splicing required

CWH - For vehicles without OE tow package

ADD - Adds to OE tow package

REPL - Replacement for OE tow package

Splice-in Converters

Make / Model	Style / Notes	Years	Rec. Size	Part#	Foot Note	PC	GTW / TW	WD / WDTW	INS	CUSTOM WIRING						Part#	Sys. Note	
										Years	Part#	Prod Type	Plug	FN	PC			INS
CHEVROLET (CONTINUED)																		
C1500	EXCL. DUAL EXHAUST OR 10" STEP BUMPER	88 - 99	2	13082	BB, K, ●	46	6.0 / 600	10 / 1000	30	88 - 99	55315	CWH	4-FLAT	E5	5	--	1	
			2	14081	AA, ●	59	10 / 1000	12 / 1200	30									
			2	15325	BB, CF, R, ●	87	16 / 2400	17 / 2400	60									
	2	13042	●	43	6.0 / 600	10 / 1000	30											
	2	13942	CC, ●	45	5.0 / 500	8.0 / 800	30											
C20	WITH DUAL EXHAUST WITH ROLL PAN BUMPER	88 - 99	2	13099	J, R	69	6.0 / 600	10 / 1000	60	85 - 86	55312	CWH	4-FLAT	E5	5	--	1	
	WITH 10" STEP BUMPER	88 - 99	2	13028	AA	45	6.0 / 600	10 / 1000	60	75 - 84	55311	CWH	4-FLAT	E5	5	--	1	
	CAB & CHASSIS	75 - 86	2	14082	AA	75	10 / 1000	12 / 1200	60									
C2500	EXCL. WITH DUAL EXHAUST, 10" STEP BUMPER OR CAB & CHASSIS	88 - 00	2	13082	BB, K, ●	46	6.0 / 600	10 / 1000	30	88 - 00	55315	CWH	4-FLAT	E5	5	--	1	
			2	14081	AA, ●	59	10 / 1000	12 / 1200	30									
			2	15325	BB, CF, R, ●	87	16 / 2400	17 / 2400	60									
	2	13042	●	43	6.0 / 600	10 / 1000	30											
	2	13099	J, R	69	6.0 / 600	10 / 1000	60											
C30	WITH 10" STEP BUMPER	88 - 00	2	15317	BB, CF, R, ●	94	16 / 2400	17 / 2400	30									
	EXCL. WITH 10" STEP BUMPER	88 - 00	2	13028	AA	45	6.0 / 600	10 / 1000	60	85 - 86	55312	CWH	4-FLAT	E5	5	--	1	
	CAB & CHASSIS	75 - 86	2	14082	AA	75	10 / 1000	12 / 1200	60	75 - 84	55311	CWH	4-FLAT	E5	5	--	1	
C3500	EXCL. WITH DUAL EXHAUST, 4-DOOR CREW CAB, 10" STEP BUMPER OR CAB & CHASSIS	88 - 00	2	13082	BB, K, ●	46	6.0 / 600	10 / 1000	30	88 - 00	55315	CWH	4-FLAT	E5	5	--	1	
			2	14081	AA, ●	59	10 / 1000	12 / 1200	30									
			2	15325	BB, CF, R, ●	87	16 / 2400	17 / 2400	60									
	2	13042	●	43	6.0 / 600	10 / 1000	30											
	2	13028	AA	45	6.0 / 600	10 / 1000	60											
C3500HD	WITH 10" STEP BUMPER	88 - 91	2	14082	AA	75	10 / 1000	12 / 1200	60									
			2	13099	J, R	69	6.0 / 600	10 / 1000	60									
			2	15317	BB, CF, R, ●	94	16 / 2400	17 / 2400	30									
	CAB & CHASSIS	88 - 00	2	13028	AA	45	6.0 / 600	10 / 1000	60									
		91 - 02	2	14082	AA	75	10 / 1000	12 / 1200	60	--	--	--				--	--	
CAPRICE	SEDAN	77 - 96	1.25	12009	BB	175	3.5 / 350	--	30	91 - 96	55347	CWH	4-FLAT	N	E6	10	--	1
	WAGON	77 - 96	1.25	12041	AA	165	3.5 / 350	--	40	91 - 96	--	--				--	1	
CAPTIVA SPORT	--	12 - 15	1.25	12095	AA, M, ●	135	3.5 / 300	--	30	13 - 15	56257	CWH	4-FLAT		E21	45	56496	5
			2	13594	A, M, ●	35	3.5 / 350	4.0 / 400	30	12 - 12	56026	CWH	4-FLAT		E18	30	56496	5
CAMARO	--	16 - 24	1.25	11900	AA, D, FR, Q, ●	141	2.0 / 200	--	45	14 - 15	56197	CWH	4-FLAT	T6	E11	15	56496	5
			1.25	11222	AA, F, ●	141	2.0 / 200	--	30	97 - 02	--	--					56496	4
	--	87 - 02	1.25	11117	BB, H	161	2.0 / 200	--	45	87 - 96	--	--					--	1
CITY EXPRESS	--	15 - 18	2	13165	BB, D, HE, ●	35	3.5 / 525	--	30	15 - 18	56279	CWH	4-FLAT		E22	45	56496	10
COBALT	COUPE, EXCL. SS	05 - 10	1.25	11430	BB, U	133	2.0 / 200	--	60	05 - 10	55432	CWH	4-FLAT		E7	15	--	1
	COUPE, SS ONLY	05 - 10	1.25	11447	BB	149	2.0 / 200	--	30									
	SEDAN, EXCL. SS	05 - 10	1.25	11430	BB, U	133	2.0 / 200	--	60	05 - 10	55434	CWH	4-FLAT		E9	10	--	1
COLORADO	--	23 - 24	2	13576	AA, Q, ●	45	8.0 / 800	10 / 1000	60	04 - 12	55510	CWH	4-FLAT	E12	10	56496	5	
			2	13203	AA, M, Q, T, ●	37	6.0 / 900	8.0 / 900	30									
	2	13176	AA, N, T, ●	43	8.0 / 800	10 / 1000	30											
	2	13252	BB, M, ●	35	4.0 / 400	6.0 / 600	30											

CUSTOM WIRING APPLICATION GUIDE FOOTNOTE KEY						For the most up-to-date application information, please visit curtmfg.com					
T1 Multiple parts available. Visit curtmfg.com	T5 Adds 4-flat to factory equipped 7-way	T9 Without factory tow package	T13 Excluding right hand drive	T17 Single rear wheels	T21 Excluding LTZ						
T2 Replaces factory connector with 4-flat	T6 Without LED taillights	T10 Hybrid only	T14 All wheel drive (AWD) models only	T18 SE models only	T22 Excluding plug-in models						
T3 Replaces factory connector with 6-way	T7 With LED taillights	T11 Excluding hybrid	T15 Excluding Grand Touring	T19 Excluding SE models	See page 33 for T23 - T63 footnote key comments						
T4 Replaces factory connector with 7-way	T8 With factory tow package	T12 Excluding EX and Limited	T16 WRX only	T20 Limited 2.0L and EX 2.0L models only	See page 33 for 'Electrical System Notes'						



TRAILER HITCHES

CUSTOM WIRING

For 1.25" ordering options, see page 32

No splicing required

CWH - For vehicles without OE tow package

ADD - Adds to OE tow package

REPL - Replacement for OE tow package

Splice-in Converters

Main table with columns: Make / Model, Style / Notes, Years, Rec. Size, Part#, Foot Note, PC, GTW / TW, WD / WDTW, INS, Years, Part#, Prod Type, Plug, FN, PC, INS, Part#, Sys. Note. Includes sections for CHEVROLET (CONTINUED), K10, K1500, K20, K2500.

TRAILER HITCH APPLICATION GUIDE FOOTNOTE KEY

For the most up-to-date application information, please visit curtmfg.com

Footnote key table with columns: A Allow additional installation time, CC Roll pan mods required, F Will not fit vehicles with ground effects, HE Hole enlargement required, L Fixed draw bar, Q Temporary bumper removal, TG Compatible with Tommy Gate lifts, VT Vertical receiver tube, AA Main body concealed, CF Carbide black finish, FR Temporary bumper fascia removal, I Will not fit with full size spare, M Round tube main body, R Boxed due to bolt-on arms, U May require battery removal, W Only with boxed rear bumper, B Relocate or modify exhaust, D Minor fascia trim required, G Add'l install w/ load level air compressors, J No spare tire relocation, N Continued white supplies last, S May interfere hands free liftgate sensor, V Under-car trim (not fascia) req'd, No drilling required, BB Main body exposed, E Noticeable fascia trim required, H Will not fit vehicles with twin tailpipes, K OEM-style hitch, P Not with roll pan bumper, T Modifications required (minor), X 158" WB models require brace removal, 118" WB models require spare tire reloc.





TRAILER HITCHES

For 1.25" ordering options, see page 32

CUSTOM WIRING

No splicing required

CWH - For vehicles without OE tow package

ADD - Adds to OE tow package

REPL - Replacement for OE tow package

Splice-in Converters

Make / Model	Style / Notes	Years	Rec. Size	Part#	Foot Note	PC	GTW / TW	WD / WDTW	INS	CUSTOM WIRING						Part#	Sys. Note		
										Years	Part#	Prod Type	Plug	FN	PC			INS	
CHEVROLET (CONTINUED)																			
K30	WITH 10" STEP BUMPER	75 - 86	2	13099	J, R	69	6.0 / 600	10 / 1000	60	85 - 86	55312	CWH	4-FLAT	E5	5	--	1		
	EXCL. WITH 10" STEP BUMPER	75 - 86	2	13028	AA	45	6.0 / 600	10 / 1000	60	75 - 84	55311	CWH	4-FLAT	E5	5	--	1		
	CAB & CHASSIS	75 - 86	2	14082	AA	75	10 / 1000	12 / 1200	60										
			2	13028	AA	45	6.0 / 600	10 / 1000	60										
K3500	EXCL. WITH DUAL EXHAUST, 10" STEP BUMPER OR CAB & CHASSIS	88 - 00	2	13082	BB, K, ●	46	6.0 / 600	10 / 1000	30	88 - 00	55315	CWH	4-FLAT	E5	5	--	1		
			2	14081	AA, ●	59	10 / 1000	12 / 1200	30										
			2	15325	BB, CF, R, ●	87	16 / 2400	17 / 2400	60										
	WITH DUAL EXHAUST	88 - 00	2	13042	●	43	6.0 / 600	10 / 1000	30										
	WITH 10" STEP BUMPER	88 - 00	2	13099	J, R	69	6.0 / 600	10 / 1000	60										
			2	15317	BB, CF, R, ●	94	16 / 2400	17 / 2400	30										
			2	13028	AA	45	6.0 / 600	10 / 1000	60										
	CAB & CHASSIS	88 - 00	2	14082	AA	75	10 / 1000	12 / 1200	60										
MALIBU	SEDAN	16 - 25	1.25	12185	BB, V, ●	129	3.5 / 350	--	30	16 - 24	56387	CWH	4-FLAT	T6	E21	45	56236	7	
		13 - 15	1.25	12115	BB, D, HE, R, ●	163	3.5 / 350	--	30		56313	CWH	4-FLAT	T7	E18	45	56496	7	
	SEDAN, EXCL. HYBRID	08 - 12	1.25	12051	AA	153	3.5 / 300	--	60	13 - 15	56176	CWH	4-FLAT	T21	E17	45	56236	7	
	SEDAN	04 - 07	1.25	12272	BB, HE, ●	159	3.5 / 350	--	30	08 - 12	56027	CWH	4-FLAT	T21	E8	10	56496	7	
MALIBU LIMITED	--	16 - 16	1.25	12115	BB, D, HE, R, ●	163	3.5 / 350	--	30	04 - 07	56013	CWH	4-FLAT	E8	20	--	2		
										16 - 16	56176	CWH	4-FLAT	T21	E17	45	56236	6	
MONTE CARLO	--	77 - 88	1.25	12005	BB, HE, ●	177	3.5 / 350	--	45	77 - 88	--	--					--	1	
ORLANDO	--	12 - 15	1.25	11278	BB, M, N, V, ●	135	2.0 / 200	--	30	12 - 12	--	--					56496	5	
PRIZM	SEDAN	98 - 02	1.25	11181	AA, V	129	2.0 / 200	--	30	98 - 02	--	--					56496	4	
S10	--	82 - 04	1.25	12011	●	145	3.5 / 350	--	45	98 - 04	55359	CWH	4-FLAT	E7	5	--	1		
			2	13021	AA, P, Q, ●	45	4.0 / 400	6.0 / 600	45	85 - 97	55312	CWH	4-FLAT	E5	5	--	1		
			2	13132	AA, M, P, ●	45	4.0 / 400	6.0 / 600	45										
	WITH ROLL PAN BUMPER	82 - 04	2	13920	A, D	56	3.5 / 350	5.0 / 500	60										
SILVERADO 1500	EXCL. FACTORY RECEIVER	19 - 25	2	13393	AA, ●	35	6.0 / 600	10 / 1000	60	--	--	--					--	--	
	WITH FACTORY RECEIVER	19 - 25	2	14019	BB, ●	79	10 / 1000	12 / 1200	60										
			2	15307	BB, CF, ●	88	16 / 2000	17 / 2000	75										
			2	13175	AA, ●	45	6.0 / 600	10 / 1000	30										
			2	14006	AA, ●	49	10 / 1000	12 / 1200	30										
			EXCL. ROLL PAN BUMPER, TOMMY GATE LIFT OR 10" DROP BUMPER	07 - 18	2	13301	T, ●	29	6.0 / 600	10 / 1000	30								
					2	14301	AA, ●	49	10 / 1000	12 / 1200	30								
					2	13322	BB, D, M, ●	35	6.0 / 600	10 / 1000	30								
			WITH ROLL PAN BUMPER	99 - 06	2	15323	BB, CF, ●	83	16 / 2400	17 / 2400	30								
					2	13332	AA, K, ●	37	6.0 / 600	10 / 1000	30								
			WITH TOMMY GATE LIFT OR 10" DROP BUMPER	99 - 06	2	14332	AA, ●	67	10 / 1000	12 / 1200	30								
	2	13932			AA, CC, ●	43	5.0 / 500	8.0 / 800	30										
WITH ROLL PAN BUMPER	99 - 12	2	13339	TG, ●	56	8.0 / 800	12 / 1200	30											
SILVERADO 1500 CLASSIC	EXCL. ROLL PAN BUMPER, TOMMY GATE LIFT OR 10" DROP BUMPER	07 - 07	2	13322	BB, D, M, ●	35	6.0 / 600	10 / 1000	30	--	--	--					--	--	
			2	13332	AA, K, ●	37	6.0 / 600	10 / 1000	30										
			2	14332	AA, ●	67	10 / 1000	12 / 1200	30										
			2	15323	BB, CF, ●	83	16 / 2400	17 / 2400	30										
	WITH ROLL PAN BUMPER	07 - 07	2	13932	AA, CC, ●	43	5.0 / 500	8.0 / 800	30										
	WITH TOMMY GATE LIFT OR 10" DROP BUMPER	07 - 07	2	13339	TG, ●	56	8.0 / 800	12 / 1200	30										
SILVERADO 1500 HD	EXCL. ROLL PAN BUMPER, TOMMY GATE LIFT OR 10" DROP BUMPER	01 - 06	2	13322	BB, D, M, ●	35	6.0 / 600	10 / 1000	30	--	--	--					--	--	
			2	13332	AA, K, ●	37	6.0 / 600	10 / 1000	30										
			2	14332	AA, ●	67	10 / 1000	12 / 1200	30										
			2	15323	BB, CF, ●	83	16 / 2400	17 / 2400	30										
	WITH ROLL PAN BUMPER	01 - 06	2	13932	AA, CC, ●	43	5.0 / 500	8.0 / 800	30										
	WITH TOMMY GATE LIFT OR 10" DROP BUMPER	01 - 06	2	13339	TG, ●	56	8.0 / 800	12 / 1200	30										

CUSTOM WIRING APPLICATION GUIDE FOOTNOTE KEY						For the most up-to-date application information, please visit curtmfg.com					
T1 Multiple parts available. Visit curtmfg.com	T5 Adds 4-flat to factory equipped 7-way	T9 Without factory tow package	T13 Excluding right hand drive	T17 Single rear wheels	T21 Excluding LTZ						
T2 Replaces factory connector with 4-flat	T6 Without LED taillights	T10 Hybrid only	T14 All wheel drive (AWD) models only	T18 SE models only	T22 Excluding plug-in models						
T3 Replaces factory connector with 6-way	T7 With LED taillights	T11 Excluding hybrid	T15 Excluding Grand Touring	T19 Excluding SE models	See page 33 for T23 - T63 footnote key comments						
T4 Replaces factory connector with 7-way	T8 With factory tow package	T12 Excluding EX and Limited	T16 WRX only	T20 Limited 2.0L and EX 2.0L models only	See page 33 for 'Electrical System Notes'						



TRAILER HITCHES

For 1.25" ordering options, see page 32

CUSTOM WIRING

No splicing required

CWH - For vehicles without OE tow package

ADD - Adds to OE tow package

REPL - Replacement for OE tow package

Splice-in Converters

Make / Model	Style / Notes	Years	Rec. Size	Part#	Foot Note	PC	GTW / TW	WD / WDTW	INS	CUSTOM WIRING						Part#	Sys. Note
										Years	Part#	Prod Type	Plug	FN	PC		
CHEVROLET (CONTINUED)																	
SILVERADO 1500 HD CLASSIC	EXCL. ROLL PAN BUMPER, TOMMY GATE LIFT OR 10" DROP BUMPER	07 - 07	2	13322	BB, D, M, ●	35	6.0 / 600	10 / 1000	30	--	--	--				--	--
			2	13332	AA, K, ●	37	6.0 / 600	10 / 1000	30								
			2	14332	AA, ●	67	10 / 1000	12 / 1200	30								
			2	15323	BB, CF, ●	83	16 / 2400	17 / 2400	30								
		WITH ROLL PAN BUMPER	07 - 07	2	13932	AA, CC, ●	43	5.0 / 500	8.0 / 800	30							
	WITH TOMMY GATE LIFT OR 10" DROP BUMPER	07 - 07	2	13339	TG, ●	56	8.0 / 800	12 / 1200	30								
SILVERADO 1500 LD	--	19 - 19	2	13175	AA, ●	45	6.0 / 600	10 / 1000	30	--	--	--				--	--
			2	13301	T, ●	29	6.0 / 600	10 / 1000	30								
			2	14006	AA, ●	49	10 / 1000	12 / 1200	30								
			2	14301	AA, ●	49	10 / 1000	12 / 1200	30								
SILVERADO 1500 LTD	EXCL. FACTORY RECEIVER	22 - 22	2	13393	AA, ●	35	6.0 / 600	10 / 1000	60	--	--	--				--	--
			2	14019	BB, ●	79	10 / 1000	12 / 1200	60								
		WITH FACTORY RECEIVER	22 - 22	2	15307	BB, CF, ●	88	16 / 2000	17 / 2000	75							
SILVERADO 2500	EXCL. TOMMY GATE LIFT, 10" DROP BUMPER OR CAB & CHASSIS	99 - 04	2	13322	BB, D, M, ●	35	6.0 / 600	10 / 1000	30	--	--	--				--	--
			2	13332	AA, K, ●	37	6.0 / 600	10 / 1000	30								
			2	14332	AA, ●	67	10 / 1000	12 / 1200	30								
			2	15323	BB, CF, ●	83	16 / 2400	17 / 2400	30								
		WITH TOMMY GATE LIFT OR 10" DROP BUMPER	99 - 04	2	13339	TG, ●	56	8.0 / 800	12 / 1200	30							
	CAB & CHASSIS	99 - 99	2	13028	AA	45	6.0 / 600	10 / 1000	60								
			2	14082	AA	75	10 / 1000	12 / 1200	60								
			2	15400	BB, CF	83	17 / 2550	17 / 2550	30								
			2.5	15800	BB, CF	88	20 / 2700	20 / 2700	30								
SILVERADO 2500 HD (CONTINUED ON THE NEXT PAGE)	6' BED, EXCL. FACTORY RECEIVER, TOMMY GATE LIFT OR CAB & CHASSIS	20 - 25	2	13447	BB, ●	88	8.0 / 800	12 / 1200	30	--	--	--				--	--
			2	14005	BB, ●	89	10 / 1000	12 / 1200	30								
			2	15007	BB, ●	97	17 / 2550	17 / 2550	30								
			2.5	15010	BB, ●	97	20 / 2700	20 / 2700	30								
			2	13178	AA, ●	56	8.0 / 800	12 / 1200	30								
			2	14009	AA, ●	63	10 / 1000	12 / 1200	30								
		15 - 19	2	15460	BB, CF	97	17 / 2550	17 / 2550	45								
			2.5	15860	BB, CF	99	20 / 2700	20 / 2700	45								
		11 - 19	2	13062	BB, ●	55	8.0 / 800	12 / 1200	30								
			2	14062	BB, ●	65	10 / 1000	12 / 1200	30								
		01 - 10	2	13208	D, ●	71	8.0 / 800	12 / 1200	40								
			2	13210	D, ●	63	6.0 / 600	10 / 1000	30								
		2	13211	BB, M, ●	63	6.0 / 600	10 / 1000	30									
		2	14211	AA, D	85	10 / 1000	12 / 1200	40									
		2.5	15703	BB, CF, ●	89	18 / 2700	18 / 2700	30									
	01 - 06	2	13108	AA, ●	45	6.0 / 600	10 / 1000	30									
		2	14108	AA, ●	71	10 / 1000	12 / 1200	30									
		6' BED, FACT. REPL. HITCH	01 - 10	2	15302	AA, CF, K, ●	79	16 / 2400	17 / 2400	30							
	8' BED, EXCL. FACTORY RECEIVER, TOMMY GATE LIFT OR CAB & CHASSIS	20 - 25	2	13447	BB, ●	88	8.0 / 800	12 / 1200	30	--	--	--				--	--
			2	14005	BB, ●	89	10 / 1000	12 / 1200	30								
			2	15007	BB, ●	97	17 / 2550	17 / 2550	30								
			2.5	15010	BB, ●	97	20 / 2700	20 / 2700	30								
			2	13187	AA, ●	63	8.0 / 800	12 / 1200	30								
			2	14010	AA, ●	67	10 / 1000	12 / 1200	30								
15 - 19		2	15460	BB, CF	97	17 / 2550	17 / 2550	45									
		2.5	15860	BB, CF	99	20 / 2700	20 / 2700	45									
11 - 19		2	13061	BB, ●	56	8.0 / 800	12 / 1200	30									
		2	14061	BB, ●	67	10 / 1000	12 / 1200	30									
01 - 10		2	13208	D, ●	71	8.0 / 800	12 / 1200	40									
		2	13210	D, ●	63	6.0 / 600	10 / 1000	30									
	2	13211	BB, M, ●	63	6.0 / 600	10 / 1000	30										
	2	14211	AA, D	85	10 / 1000	12 / 1200	40										
	2.5	15703	BB, CF, ●	89	18 / 2700	18 / 2700	30										
01 - 06	2	14008	AA, ●	69	10 / 1000	12 / 1200	30										

TRAILER HITCH APPLICATION GUIDE FOOTNOTE KEY

For the most up-to-date application information, please visit curtmfg.com

A Allow additional installation time	CC Roll pan mods required	F Will not fit vehicles with ground effects	HE Hole enlargement required	L Fixed draw bar	Q Temporary bumper removal	TG Compatible with Tommy Gate lifts	VT Vertical receiver tube
AA Main body concealed	CF Carbide black finish	FR Temporary bumper fascia removal	I Will not fit with full size spare	M Round tube main body	R Boxed due to bolt-on arms	U May require battery removal	W Only with boxed rear bumper
B Relocate or modify exhaust	D Minor fascia trim required	G Add'l install w/ load level air compressors	J No spare tire relocation	N Continued while supplies last	S May interfere hands free liftgate sensor	V Under-car trim (not fascia) req'd	● No drilling required
BB Main body exposed	E Noticeable fascia trim required	H Will not fit vehicles with twin tailpipes	K OEM-style hitch	P Not with roll pan bumper	T Modifications required (minor)	X 158" WB models require brace removal, 118" WB models require spare tire reloc.	



TRAILER HITCHES

For 1.25" ordering options, see page 32

CUSTOM WIRING

No splicing required

CWH - For vehicles without OE tow package

ADD - Adds to OE tow package

REPL - Replacement for OE tow package

Splice-in Converters

Make / Model	Style / Notes	Years	Rec. Size	Part#	Foot Note	PC	GTW / TW	WD / WDTW	INS	CUSTOM WIRING						Part#	Sys. Note
										Years	Part#	Prod Type	Plug	FN	PC		
CHEVROLET (CONTINUED)																	
SILVERADO 2500 HD	8' BED, BOX DELETE	11 - 12	2	15363	BB, CF, ●	79	16 / 2400	17 / 2400	30								
	8' BED, FACTORY REPL. HITCH	01 - 10	2	15312	BB, CF, K, ●	79	16 / 2400	17 / 2400	30								
(CONTINUED FROM THE PREVIOUS PAGE)	8' BED, WITH TOMMY GATE LIFT	01 - 10	2	13213	A, TG, ●	71	8.0 / 800	12 / 1200	30								
	8' BED, WITH 10" STEP BUMPER	01 - 10	2	15313	BB, CF, ●	85	16 / 2400	17 / 2400	30								
SILVERADO 2500 HD CLASSIC	6' BED, EXCL. FACTORY RECEIVER, TOMMY GATE LIFT OR CAB & CHASSIS	07 - 07	2	13208	D, ●	71	8.0 / 800	12 / 1200	40	--	--	--				--	--
			2	13210	D, ●	63	6.0 / 600	10 / 1000	30								
			2	13211	BB, M, ●	63	6.0 / 600	10 / 1000	30								
			2	13108	AA, ●	45	6.0 / 600	10 / 1000	30								
			2	14108	AA, ●	71	10 / 1000	12 / 1200	30								
			2	14211	AA, D	85	10 / 1000	12 / 1200	40								
	2.5	15703	BB, CF, ●	89	18 / 2700	18 / 2700	30										
	6' BED, FACT. REPL. HITCH	07 - 07	2	15302	AA, CF, K, ●	79	16 / 2400	17 / 2400	30								
	8' BED, EXCL. FACTORY RECEIVER, TOMMY GATE LIFT OR CAB & CHASSIS	07 - 07	2	13208	D, ●	71	8.0 / 800	12 / 1200	40	--	--	--				--	--
			2	13210	D, ●	63	6.0 / 600	10 / 1000	30								
			2	13211	BB, M, ●	63	6.0 / 600	10 / 1000	30								
			2	14008	AA, ●	69	10 / 1000	12 / 1200	30								
	8' BED, FACTORY REPL. HITCH	07 - 07	2	15312	BB, CF, K, ●	79	16 / 2400	17 / 2400	30								
8' BED, WITH TOMMY GATE LIFT	07 - 07	2	13213	A, TG, ●	71	8.0 / 800	12 / 1200	30									
8' BED, WITH 10" STEP BUMPER	07 - 07	2	15313	BB, CF, ●	85	16 / 2400	17 / 2400	30									
SILVERADO 3500	6' BED, EXCL. FACTORY RECEIVER, TOMMY GATE LIFT OR CAB & CHASSIS	01 - 06	2	13208	D, ●	71	8.0 / 800	12 / 1200	40	--	--	--				--	--
			2	13210	D, ●	63	6.0 / 600	10 / 1000	30								
			2	13211	BB, M, ●	63	6.0 / 600	10 / 1000	30								
			2	13108	AA, ●	45	6.0 / 600	10 / 1000	30								
			2	14108	AA, ●	71	10 / 1000	12 / 1200	30								
			2	14211	AA, D	85	10 / 1000	12 / 1200	40								
	2.5	15703	BB, CF, ●	89	18 / 2700	18 / 2700	30										
	6' BED, FACTORY REPL. HITCH	01 - 06	2	15302	AA, CF, K, ●	79	16 / 2400	17 / 2400	30								
	8' BED, EXCL. FACTORY RECEIVER, TOMMY GATE LIFT, 10" DROP BUMPER AND CAB & CHASSIS	01 - 06	2	13208	D, ●	71	8.0 / 800	12 / 1200	40	--	--	--				--	--
			2	13210	D, ●	63	6.0 / 600	10 / 1000	30								
			2	13211	BB, M, ●	63	6.0 / 600	10 / 1000	30								
			2	14211	AA, D	85	10 / 1000	12 / 1200	40								
			2.5	15703	BB, CF, ●	89	18 / 2700	18 / 2700	30								
2	14008	AA, ●	69	10 / 1000	12 / 1200	30											
8' BED, FACTORY REPL. HITCH	01 - 06	2	15312	BB, CF, K, ●	79	16 / 2400	17 / 2400	30									
8' BED, WITH TOMMY GATE LIFT	01 - 06	2	13213	A, TG, ●	71	8.0 / 800	12 / 1200	30									
8' BED, WITH 10" DROP BUMPER	01 - 06	2	15313	BB, CF, ●	85	16 / 2400	17 / 2400	30									
CAB & CHASSIS	01 - 06	2	13028	AA	45	6.0 / 600	10 / 1000	60	--	--	--				--	--	
		2	14082	AA	75	10 / 1000	12 / 1200	60									
		2	15400	BB, CF	83	17 / 2550	17 / 2550	30									
2.5	15800	BB, CF	88	20 / 2700	20 / 2700	30											

CUSTOM WIRING APPLICATION GUIDE FOOTNOTE KEY						For the most up-to-date application information, please visit curtmfg.com					
T1 Multiple parts available. Visit curtmfg.com	T5 Adds 4-flat to factory equipped 7-way	T9 Without factory tow package	T13 Excluding right hand drive	T17 Single rear wheels	T21 Excluding LTZ						
T2 Replaces factory connector with 4-flat	T6 Without LED taillights	T10 Hybrid only	T14 All wheel drive (AWD) models only	T18 SE models only	T22 Excluding plug-in models						
T3 Replaces factory connector with 6-way	T7 With LED taillights	T11 Excluding hybrid	T15 Excluding Grand Touring	T19 Excluding SE models	See page 33 for T23 - T63 footnote key comments						
T4 Replaces factory connector with 7-way	T8 With factory tow package	T12 Excluding EX and Limited	T16 WRX only	T20 Limited 2.0L and EX 2.0L models only	See page 33 for 'Electrical System Notes'						



TRAILER HITCHES

For 1.25" ordering options, see page 32

CUSTOM WIRING

No splicing required

CWH - For vehicles without OE tow package

ADD - Adds to OE tow package

REPL - Replacement for OE tow package

Splice-in Converters

Make / Model	Style / Notes	Years	TRAILER HITCHES							CUSTOM WIRING										
			Rec. Size	Part#	Foot Note	PC	GTW / TW	WD / WDTW	INS	Years	Part#	Prod Type	Plug	FN	PC	INS	Part#	Sys. Note		
CHEVROLET (CONTINUED)																				
SILVERADO 3500 CLASSIC	EXCL. FACTORY RECEIVER, TOMMY GATE LIFT, 10" DROP BUMPER AND CAB & CHASSIS	07 - 07	2	13208	D, ●	71	8.0 / 800	12 / 1200	40	--	--	--					--	--		
			2	13210	D, ●	63	6.0 / 600	10 / 1000	30											
			2	13211	BB, M, ●	63	6.0 / 600	10 / 1000	30											
			2	14211	AA, D	85	10 / 1000	12 / 1200	40											
			2.5	15703	BB, CF, ●	89	18 / 2700	18 / 2700	30											
		2	14008	AA, ●	69	10 / 1000	12 / 1200	30												
			FACTORY REPL. HITCH	07 - 07	2	15312	BB, CF, K, ●	79	16 / 2400	17 / 2400	30									
			WITH TOMMY GATE LIFT	07 - 07	2	13213	A, TG, ●	71	8.0 / 800	12 / 1200	30									
			WITH 10" DROP BUMPER	07 - 07	2	15313	BB, CF, ●	85	16 / 2400	17 / 2400	30									
			CAB & CHASSIS	07 - 07	2	13028	AA	45	6.0 / 600	10 / 1000	60	--	--	--					--	--
			2	14082	AA	75	10 / 1000	12 / 1200	60											
			2	15400	BB, CF	83	17 / 2550	17 / 2550	30											
			2.5	15800	BB, CF	88	20 / 2700	20 / 2700	30											
SILVERADO 3500 HD	6' BED, EXCL. FACTORY RECEIVER, TOMMY GATE LIFT OR CAB & CHASSIS	20 - 25	2	13447	BB, ●	88	8.0 / 800	12 / 1200	30	--	--	--					--	--		
			2	14005	BB, ●	89	10 / 1000	12 / 1200	30											
			2	15007	BB, ●	97	17 / 2550	17 / 2550	30											
			2.5	15010	BB, ●	97	20 / 2700	20 / 2700	30											
				15 - 19	2	13178	AA, ●	56	8.0 / 800	12 / 1200	30									
					2	14009	AA, ●	63	10 / 1000	12 / 1200	30									
				11 - 19	2	15460	BB, CF	97	17 / 2550	17 / 2550	45									
					2.5	15860	BB, CF	99	20 / 2700	20 / 2700	45									
					2	13062	BB, ●	55	8.0 / 800	12 / 1200	30									
					2	14062	BB, ●	65	10 / 1000	12 / 1200	30									
				20 - 25	2	13447	BB, ●	88	8.0 / 800	12 / 1200	30	--	--	--					--	--
					2	14005	BB, ●	89	10 / 1000	12 / 1200	30									
				2	15007	BB, ●	97	17 / 2550	17 / 2550	30										
				2.5	15010	BB, ●	97	20 / 2700	20 / 2700	30										
			15 - 19	2	13187	AA, ●	63	8.0 / 800	12 / 1200	30										
				2	14010	AA, ●	67	10 / 1000	12 / 1200	30										
			11 - 19	2	15460	BB, CF	97	17 / 2550	17 / 2550	45										
				2.5	15860	BB, CF	99	20 / 2700	20 / 2700	45										
			11 - 14	2	13061	BB, ●	56	8.0 / 800	12 / 1200	30										
				2	14061	BB, ●	67	10 / 1000	12 / 1200	30										
			07 - 10	2	13208	D, ●	71	8.0 / 800	12 / 1200	40										
				2	13210	D, ●	63	6.0 / 600	10 / 1000	30										
				2	13211	BB, M, ●	63	6.0 / 600	10 / 1000	30										
				2	14211	AA, D	85	10 / 1000	12 / 1200	40										
				2.5	15703	BB, CF, ●	89	18 / 2700	18 / 2700	30										
		8' BED, BOX DELETE	11 - 12	2	15363	BB, CF, ●	79	16 / 2400	17 / 2400	30										
		8' BED, FACTORY REPL. HITCH	07 - 10	2	15312	BB, CF, K, ●	79	16 / 2400	17 / 2400	30										
		8' BED, WITH TOMMY GATE LIFT	07 - 10	2	13213	A, TG, ●	71	8.0 / 800	12 / 1200	30										
	8' BED, WITH 10" STEP BUMPER	07 - 10	2	15313	BB, CF, ●	85	16 / 2400	17 / 2400	30											
	CAB & CHASSIS	07 - 25	2	15400	BB, CF	83	17 / 2550	17 / 2550	30	--	--	--					--	--		
			2.5	15800	BB, CF	88	20 / 2700	20 / 2700	30											
SPARK	--	16 - 22	1.25	11433	AA, D, HE, ●	129	2.0 / 200	--	40	13 - 22	--	--					56236	10		
	WITHOUT GROUND EFFECTS	13 - 15	1.25	11334	AA, HE, ●	129	2.0 / 200	--	30											
SONIC	HATCHBACK	17 - 20	1.25	11464	BB, ●	135	2.0 / 200	--	30	12 - 16	56303	CWH	4-FLAT	E24	45		56236	7		
	HATCHBACK, EXCL. RS	12 - 16	1.25	11258	BB, ●	149	2.0 / 200	--	30											
	SEDAN	12 - 20	1.25	11240	BB, HE, ●	137	2.0 / 200	--	30	12 - 16	56303	CWH	4-FLAT	E24	45		56236	7		

TRAILER HITCH APPLICATION GUIDE FOOTNOTE KEY					For the most up-to-date application information, please visit curtmfg.com				
A Allow additional installation time	CC Roll pan mods required	F Will not fit vehicles with ground effects	HE Hole enlargement required	L Fixed draw bar	Q Temporary bumper removal	TG Compatible with Tommy Gate lifts	VT Vertical receiver tube		
AA Main body concealed	CF Carbide black finish	FR Temporary bumper fascia removal	I Will not fit with full size spare	M Round tube main body	R Boxed due to bolt-on arms	U May require battery removal	W Only with boxed rear bumper		
B Relocate or modify exhaust	D Minor fascia trim required	G Add'l install w/ load level air compressors	J No spare tire relocation	N Continued white supplies last	S May interfere hands free liftgate sensor	V Under-car trim (not fascia) req'd	● No drilling required		
BB Main body exposed	E Noticeable fascia trim required	H Will not fit vehicles with twin tailpipes	K OEM-style hitch	P Not with roll pan bumper	T Modifications required (minor)	X 158" WB models require brace removal, 118" WB models require spare tire reloc.			



TRAILER HITCHES

For 1.25" ordering options, see page 32

CUSTOM WIRING

No splicing required

CWH - For vehicles without OE tow package

ADD - Adds to OE tow package

REPL - Replacement for OE tow package

Splice-in Converters

Make / Model	Style / Notes	Years	Rec. Size	Part#	Foot Note	PC	GTW / TW	WD / WDTW	INS	CUSTOM WIRING						Splice-in Converters		
										Years	Part#	Prod Type	Plug	FN	PC	INS	Part#	Sys. Note
CHEVROLET (CONTINUED)																		
SUBURBAN	--	03 - 06	2	13422	BB, K, M, ●	45	6.0 / 600	10 / 1000	30	03 - 06	55319	CWH	4-FLAT	E5	5	--	1	
			2	15324	BB, CF, ●	71	16 / 2400	17 / 2400	30	92 - 99	55319	CWH	4-FLAT	E5	5	--	1	
		00 - 02	2	13402	●	43	6.0 / 600	10 / 1000	30	85 - 91	55312	CWH	4-FLAT	E5	5	--	1	
			2	14080	BB, ●	65	10 / 1000	12 / 1200	30	73 - 84	55311	CWH	4-FLAT	E5	5	--	1	
			2	13029	BB, HE, ●	39	6.0 / 600	10 / 1000	30									
		92 - 99	2	13121	M, ●	46	5.0 / 500	6.0 / 600	30									
			2	14029	BB, HE, ●	63	10 / 1000	12 / 1200	30									
73 - 91	2	13017	●	53	6.0 / 600	10 / 1000	40											
TAHOE	POLICE PACKAGE	07 - 14	2	13161	BB, M, ●	37	6.0 / 600	--	30	95 - 00	55319	CWH	4-FLAT	E5	5	--	1	
	--	03 - 06	2	13422	BB, K, M, ●	45	6.0 / 600	10 / 1000	30									
			2	15324	BB, CF, ●	71	16 / 2400	17 / 2400	30									
	NEW BODY STYLE, 4.8L OR 5.3L	00 - 02	2	13402	●	43	6.0 / 600	10 / 1000	30									
			2	14080	BB, ●	65	10 / 1000	12 / 1200	30									
	OLD BODY STYLE, 5.7L OR 6.5L	95 - 00	2	13029	BB, HE, ●	39	6.0 / 600	10 / 1000	30									
2			13121	M, ●	46	5.0 / 500	6.0 / 600	30										
2	14029	BB, HE, ●	63	10 / 1000	12 / 1200	30												
TRACKER	--	99 - 04	1.25	11024	BB, N, ●	159	2.0 / 200	--	30	98 - 04	55372	CWH	4-FLAT	E9	5	56496	4	
TRAILBLAZER	--	21 - 25	1.25	11612	AA, D, FR, Q, ●	149	2.0 / 200	--	90	21 - 23	--	--				56236	6	
			2	13584	AA, D, FR, Q, ●	46	2.0 / 200	--	50	99 - 01	55411	CWH	4-FLAT	E2	15	--	1	
		99 - 01	2	13020	●	37	5.0 / 500	6.0 / 600	30									
2	13300	M, ●	43	4.0 / 400	6.0 / 600	30												
TRAVERSE	--	24 - 24	2	13614	AA, FR, Q, ●	39	5.0 / 500	5.0 / 500	120	24 - 24	56538	CWH	4-FLAT	E10	20	--	1	
			2	13433	AA, FR, Q, ●	39	5.0 / 750	5.0 / 750	40		56537	CWH	7-WAY	E18	20	--	--	
		18 - 23	2	13424	AA, ●	25	5.0 / 500	6.0 / 600	30	18 - 23	56393	CWH	7-WAY	T4	E13	20	--	--
			2	13424	AA, ●	25	5.0 / 500	6.0 / 600	30		56394	CWH	4-FLAT	T2	E6	20	--	--
		09 - 17	2	13424	AA, ●	25	5.0 / 500	6.0 / 600	30	13 - 17	56245	REPL	4-FLAT	T2	E11	20	56496	2
									56181	CWH	4-FLAT	E25	45	56496	5			
TRAVERSE LIMITED	--	24 - 24	2	13433	AA, FR, Q, ●	39	5.0 / 750	5.0 / 750	40	24 - 24	56393	CWH	7-WAY	T4	E13	20	--	--
			2	13433	AA, FR, Q, ●	39	5.0 / 750	5.0 / 750	40		56394	CWH	4-FLAT	T2	E6	20	--	--
TRAX	--	24 - 25	2	13585	BB, M, ●	45	2.0 / 200	--	30	24 - 24	56514	CWH	4-FLAT	E27	45	56236	2	
		15 - 22	1.25	11527	BB, HE, M, ●	155	2.0 / 200	--	30	19 - 22	56419	CWH	4-FLAT	T7	E23	45	56236	5
									15 - 18	--	--					56496	5	
UPLANDER	121" WHEELBASE ONLY	05 - 09	2	13336	●	43	4.0 / 400	6.0 / 600	30	09 - 09	--	--				--	1	
	--	05 - 09	2	13344	AA	46	4.0 / 400	6.0 / 600	30	06 - 09	56077	CWH	4-FLAT	E5	15	--	1	
VENTURE	--	97 - 05	2	13344	AA	46	4.0 / 400	6.0 / 600	30	97 - 05	55355	CWH	4-FLAT	E12	10	56496	4	
VOLT	--	16 - 19	1.25	11436	AA, FR, Q, V, ●	125	1.0 / 100	--	30	16 - 19	56315	CWH	4-FLAT	E19	45	56496	5	
		11 - 15	1.25	11221	AA, V	147	1.0 / 100	--	45	11 - 12	--	--					56496	2
CHRYSLER																		
200	--	15 - 17	1.25	11403	AA	137	2.0 / 200	--	40	15 - 17	56242	CWH	4-FLAT	E18	45	56496	2	
		11 - 14	1.25	11133	AA, ●	135	2.0 / 200	--	30	11 - 14	56211	CWH	4-FLAT	E21	45	56496	5	
300	--	15 - 23	2	13236	BB, M, ●	37	3.5 / 350	--	30	15 - 23	56235	CWH	4-FLAT	E21	45	56496	2	
		05 - 10	1.25	12240	N, ●	153	3.5 / 350	--	30	11 - 14	56145	CWH	4-FLAT	E24	15	--	1	
300C	--	11 - 17	2	13465	●	33	3.5 / 350	--	30	05 - 10	55534	CWH	4-FLAT	E12	10	--	1	
			1.25	12064	AA, ●	133	3.5 / 350	--	45	15 - 23	56235	CWH	4-FLAT	E21	45	56496	2	
		2	13093	AA, ●	27	3.5 / 350	--	45	11 - 14	56145	CWH	4-FLAT	E24	15	--	--		
05 - 10	1.25	12240	N, ●	153	3.5 / 350	--	30	05 - 10	55546	CWH	4-FLAT	E18	15	56496	5			
300S	--	12 - 23	1.25	12064	AA, ●	133	3.5 / 350	--	45	15 - 23	56235	CWH	4-FLAT	E21	45	56496	2	
			2	13093	AA, ●	27	3.5 / 350	--	45	12 - 14	56145	CWH	4-FLAT	E24	15	--	10	

CUSTOM WIRING APPLICATION GUIDE FOOTNOTE KEY						For the most up-to-date application information, please visit curtmfg.com					
T1 Multiple parts available. Visit curtmfg.com	T5 Adds 4-flat to factory equipped 7-way	T9 Without factory tow package	T13 Excluding right hand drive	T17 Single rear wheels	T21 Excluding LTZ						
T2 Replaces factory connector with 4-flat	T6 Without LED taillights	T10 Hybrid only	T14 All wheel drive (AWD) models only	T18 SE models only	T22 Excluding plug-in models						
T3 Replaces factory connector with 6-way	T7 With LED taillights	T11 Excluding hybrid	T15 Excluding Grand Touring	T19 Excluding SE models	See page 33 for T23 - T63 footnote key comments						
T4 Replaces factory connector with 7-way	T8 With factory tow package	T12 Excluding EX and Limited	T16 WRX only	T20 Limited 2.0L and EX 2.0L models only	See page 33 for 'Electrical System Notes'						



TRAILER HITCHES

For 1.25" ordering options, see page 32

CUSTOM WIRING

No splicing required

CWH - For vehicles without OE tow package

ADD - Adds to OE tow package

REPL - Replacement for OE tow package

Splice-in Converters

Make / Model	Style / Notes	Years	TRAILER HITCHES							CUSTOM WIRING						Part#	Sys. Note	
			Rec. Size	Part#	Foot Note	PC	GTW / TW	WD / WDTW	INS	Years	Part#	Prod Type	Plug	FN	PC			INS
CHRYSLER (CONTINUED)																		
ASPEN	--	07 - 09	2	13296	M, ●	49	6.0 / 600	10 / 1000	30	07 - 09	55597	CWH	4-FLAT	E20	25	56496	5	
			2	13072	D, V	14	6.0 / 600	9.0 / 900	60		55381	ADD	4-FLAT	T5	E9	5	56496	2
			2	13072	D, V	14	6.0 / 600	9.0 / 900	60									
PACIFICA	--	17 - 24	1.25	12180	BB, HE, M, ●	145	3.5 / 350	--	45	21 - 24	56492	CWH	4-FLAT	E23	45	56236	10	
			2	13383	BB, D, HE, M, ●	35	4.0 / 400	5.0 / 500	45	17 - 20	56399	CWH	4-FLAT	T6	E25	45	56236	2
		17 - 24	2	13466	AA, M, V, ●	47	4.0 / 400	5.0 / 500	60		56322	CWH	4-FLAT	T7	E30	45	56236	2
		17 - 21	2	13462	AA, M, V, ●	35	4.0 / 400	5.0 / 500	60	04 - 08	55530	CWH	4-FLAT		E20	25	56496	5
	EXCL. HYBRID	04 - 08	2	13529	AA, M, ●	49	3.5 / 350	5.0 / 500	30		55381	ADD	4-FLAT	T5	E9	5	56496	2
PT CRUISER	--	00 - 10	1.25	11132	AA, ●	145	2.0 / 200	--	30	01 - 10	55532	CWH	4-FLAT		E18	20	56496	5
SEBRING	SEDAN	07 - 10	1.25	12189	AA, HE, N, ●	145	3.5 / 350	--	30	07 - 10	--						56496	5
TOWN & COUNTRY	--	08 - 16	1.25	12264	●	153	3.5 / 350	--	45	11 - 16	56331	CWH	4-FLAT		E23	45	56496	2
			2	13364	AA, D, ●	16	4.0 / 400	5.0 / 500	30	08 - 10	56333	CWH	4-FLAT		E20	30	56236	2
	WITH STOW 'N GO	04 - 07	1.25	12289	●	163	3.5 / 350	--	30	04 - 07	55537	CWH	4-FLAT		E11	20	--	1
			2	13389	●	71	3.5 / 350	4.0 / 400	30	01 - 03	55376	CWH	4-FLAT		E12	15	56496	4
	EXCL. STOW 'N GO	96 - 07	1.25	12362	AA	137	3.5 / 350	--	30	96 - 00	55334	CWH	4-FLAT		E17	20	56496	4
		1.25	12094	BB, ●	129	3.5 / 350	--	30	91 - 95	55323	CWH	4-FLAT		E7	10	--	1	
		2	13362	AA	43	4.0 / 400	5.0 / 500	30										
VOYAGER	--	17 - 24	1.25	12180	BB, HE, M, ●	145	3.5 / 350	--	45	20 - 24	56399	CWH	4-FLAT		E25	45	56236	2
			2	13383	BB, D, HE, M, ●	35	4.0 / 400	5.0 / 500	45									
		00 - 03	2	13362	AA	43	4.0 / 400	5.0 / 500	30									
DODGE																		
AVENGER	--	11 - 14	1.25	11133	AA, ●	135	2.0 / 200	--	30	11 - 14	56211	CWH	4-FLAT		E21	45	56496	5
	EXCL. R/T	08 - 10	1.25	12189	AA, HE, N, ●	145	3.5 / 350	--	30	08 - 10	56028	CWH	4-FLAT	N	E26	30	56496	5
CALIBER	EXCL. SRT	07 - 12	1.25	11006	AA, ●	145	2.0 / 200	--	30	08 - 12	56333	CWH	4-FLAT		E20	30	56236	2
										07 - 07	--						56496	5
CARAVAN	WITH STOW 'N GO	04 - 07	1.25	12289	●	163	3.5 / 350	--	30	04 - 07	55537	CWH	4-FLAT		E11	20	--	1
			2	13389	●	71	3.5 / 350	4.0 / 400	30	01 - 03	55376	CWH	4-FLAT		E12	15	56496	4
	EXCL. STOW 'N GO AND SPORT	96 - 07	1.25	12362	AA	137	3.5 / 350	--	30	96 - 00	55334	CWH	4-FLAT		E17	20	56496	4
		2	13362	AA	43	4.0 / 400	5.0 / 500	30	91 - 95	55323	CWH	4-FLAT		E7	10	--	1	
EXCL. STOW 'N GO	96 - 07	1.25	12094	BB, ●	129	3.5 / 350	--	30										
CHALLENGER	EXCL. DEMON, HELLCAT AND SRT	11 - 23	2	13236	BB, M, ●	37	3.5 / 350	--	30	15 - 23	56230	CWH	4-FLAT		E22	45	56496	2
	--	11 - 23	1.25	12064	AA, ●	133	3.5 / 350	--	45	08 - 14	55534	CWH	4-FLAT		E12	10	--	1
		15 - 16	2	13093	AA, ●	27	3.5 / 350	--	45									
		08 - 10	1.25	12240	N, ●	153	3.5 / 350	--	30									
			2	13465	●	33	3.5 / 350	--	30									
CHARGER	EXCL. GT AND HELLCAT	15 - 23	2	13236	BB, M, ●	37	3.5 / 350	--	30	15 - 23	56234	CWH	4-FLAT		E19	45	56496	2
	--	12 - 16	2	13093	AA, ●	27	3.5 / 350	--	45	11 - 14	56135	CWH	4-FLAT		E21	25	--	--
		11 - 15	1.25	12064	AA, ●	133	3.5 / 350	--	45	06 - 10	55534	CWH	4-FLAT		E12	10	--	1
		06 - 10	1.25	12240	N, ●	153	3.5 / 350	--	30									
			2	13465	●	33	3.5 / 350	--	30									
DAKOTA	--	05 - 10	2	13230	●	35	5.0 / 500	--	30	04 - 10	55323	CWH	4-FLAT		E7	10	--	1
			2	13229	AA, K, ●	14	5.0 / 500	5.5 / 550	30	00 - 09	55381	ADD	4-FLAT	T5	E9	5	--	1
		97 - 04	2	13280	AA	45	5.0 / 500	8.0 / 800	30	95 - 03	55329	CWH	4-FLAT		E11	5	--	1
			2	13145	M, ●	46	5.0 / 500	6.0 / 600	30	87 - 94	55317	CWH	4-FLAT		E8	5	--	1
		87 - 96	2	13280	AA	45	5.0 / 500	8.0 / 800	30									
			2	13145	M	46	5.0 / 500	6.0 / 600	30									
DART	--	13 - 16	1.25	11281	AA, V, ●	149	2.0 / 200	--	30	13 - 16	56179	CWH	4-FLAT		E18	45	--	2
DURANGO	EXCL. SRT	11 - 25	2	13182	BB, I, M, ●	27	6.0 / 600	7.5 / 750	30	14 - 24	56336	CWH	4-FLAT		E21	30	56236	2
	--	04 - 09	2	13072	D, V	14	6.0 / 600	9.0 / 900	60	11 - 13	56133	CWH	4-FLAT	N	E11	10	--	1
		07 - 09	2	13296	M, ●	49	6.0 / 600	10 / 1000	30	11 - 13	56333	CWH	4-FLAT		E20	30	56236	5
		04 - 06	2	13297	M, ●	46	6.0 / 600	9.0 / 900	30	00 - 07	55381	ADD	4-FLAT	T5	E9	5	56496	2
		98 - 03	2	13056	BB, M, N, ●	59	5.0 / 500	6.0 / 600	30	04 - 09	55597	CWH	4-FLAT		E20	25	56496	5
										98 - 03	55334	CWH	4-FLAT		E17	20	56496	4

TRAILER HITCH APPLICATION GUIDE FOOTNOTE KEY For the most up-to-date application information, please visit curtmfg.com

A Allow additional installation time	CC Roll pan mods required	F Will not fit vehicles with ground effects	HE Hole enlargement required	L Fixed draw bar	Q Temporary bumper removal	TG Compatible with Tommy Gate lifts	VT Vertical receiver tube
AA Main body concealed	CF Carbide black finish	FR Temporary bumper fascia removal	I Will not fit with full size spare	M Round tube main body	R Boxed due to bolt-on arms	U May require battery removal	W Only with boxed rear bumper
B Relocate or modify exhaust	D Minor fascia trim required	G Add'l install w/ load level air compressors	J No spare tire relocation	N Continued while supplies last	S May interfere hands free liftgate sensor	V Under-car trim (not fascia) req'd	● No drilling required
BB Main body exposed	E Noticeable fascia trim required	H Will not fit vehicles with twin tailpipes	K OEM-style hitch	P Not with roll pan bumper	T Modifications required (minor)	X 158" WB models require brace removal, 118" WB models require spare tire reloc.	



TRAILER HITCHES

For 1.25" ordering options, see page 32

CUSTOM WIRING

No splicing required

CWH - For vehicles without OE tow package

ADD - Adds to OE tow package

REPL - Replacement for OE tow package

Splice-in Converters

Make / Model	Style / Notes	Years	Rec. Size	Part#	Foot Note	PC	GTW / TW	WD / WDTW	INS	CUSTOM WIRING						Part#	Sys. Note	
										Years	Part#	Prod Type	Plug	FN	PC			INS
DODGE (CONTINUED)																		
GRAND CARAVAN	--	08 - 20	1.25	12264	●	153	3.5 / 350	--	45	11 - 20	56331	CWH	4-FLAT	E23	45	56496	2	
			2	13364	AA, D, ●	16	4.0 / 400	5.0 / 500	30	08 - 10	56333	CWH	4-FLAT	E20	30	56236	2	
	WITH STOW 'N GO	04 - 07	1.25	12289	●	163	3.5 / 350	--	30	04 - 07	55537	CWH	4-FLAT	E11	20	--	1	
			2	13389	●	71	3.5 / 350	4.0 / 400	30	01 - 03	55376	CWH	4-FLAT	E12	15	56496	4	
	EXCL. STOW 'N GO AND SPORT	96 - 07	1.25	12362	AA	137	3.5 / 350	--	30	96 - 00	55334	CWH	4-FLAT	E17	20	56496	4	
		2	13362	AA	43	4.0 / 400	5.0 / 500	30	91 - 95	55323	CWH	4-FLAT	E7	10	--	1		
	EXCL. STOW 'N GO	96 - 07	1.25	12094	BB, ●	129	3.5 / 350	--	30									
HORNET	--	23 - 24	2	13553	AA, D, ●	45	2.0 / 200	--	90	23 - 24	56498	CWH	4-FLAT	E32	45	56236	7	
JOURNEY	--	09 - 20	1.25	12134	M, ●	145	3.5 / 350	--	30	11 - 20	56330	CWH	4-FLAT	T7	E21	45	56236	5
			2	13201	BB, M, ●	35	4.0 / 400	4.0 / 400	30	12 - 20	56109	CWH	4-FLAT	T6	E9	15	--	1
										10 - 10	56109	CWH	4-FLAT		E9	15	--	1
										09 - 09	56037	CWH	4-FLAT		E28	30	56496	5
MAGNUM	--	05 - 08	1.25	12240	N, ●	153	3.5 / 350	--	30	05 - 08	55562	CWH	4-FLAT		E21	30	56496	5
			2	13465	●	33	3.5 / 350	--	30									
NITRO	--	07 - 12	2	13334	M, ●	35	3.5 / 350	5.0 / 500	30	07 - 12	56334	CWH	4-FLAT		E24	15	56236	5
RAIDER	--	87 - 89	1.25	12181	N, ●	167	3.5 / 300	--	30	87 - 89	--	--				--	1	
RAM 1500	EXCL. FACTORY RECEIVER	03 - 10	2	13333	K, ●	12	6.0 / 600	10 / 1000	30	00 - 08	55381	ADD	4-FLAT	T5	E9	5	--	1
		09 - 10	2	13374	BB, M, ●	51	6.0 / 600	10 / 1000	45	02 - 05	55504	CWH	4-FLAT		E17	10	56496	5
			2	14374	BB, M, ●	71	10 / 1000	12 / 1200	45	95 - 01	55329	CWH	4-FLAT		E11	5	--	1
			2	15572	BB, CF, M, ●	63	15 / 1500	16 / 1600	30	86 - 94	55317	CWH	4-FLAT		E8	5	--	1
	WILL NOT FIT WITH FACTORY RECEIVER (BUILT IN OR AFTER 11/02)	03 - 08	2	13361	BB, ●	69	6.0 / 600	10 / 1000	30									
			2	14361	BB, ●	77	10 / 1000	12 / 1200	30									
			2.5	15704	BB, CF, ●	97	18 / 2700	18 / 2700	30									
	WITH OR WITHOUT FACTORY RECEIVER (BUILT IN OR AFTER 11/02)	03 - 08	2	15409	BB, CF, ●	89	17 / 2550	17 / 2550	30									
			2.5	15809	BB, CF, ●	99	20 / 2700	20 / 2700	30									
	FACTORY STYLE (BUILT BEFORE 11/02)	02 - 02	2	13326	K, ●	12.5	5.0 / 500	10 / 1000	30									
	6' BED ONLY (BUILT BEFORE 11/02)	02 - 02	2	13320	N, ●	37	6.0 / 600	10 / 1000	30									
	8' BED ONLY (BUILT BEFORE 11/02)	02 - 02	2	13361	BB, ●	69	6.0 / 600	10 / 1000	30									
			2	14361	BB, ●	77	10 / 1000	12 / 1200	30									
	EXCL. ROLL PAN BUMPER	68 - 01	2	13310	AA	35	6.0 / 600	10 / 1000	60									
		2	14001	AA	59	10 / 1000	12 / 1200	60										
		2	15300	BB, CF	67	16 / 2400	17 / 2400	60										
RAM 2500	EXCL. FACTORY RECEIVER	03 - 10	2	13333	K, ●	12	6.0 / 600	10 / 1000	30	00 - 10	55381	ADD	4-FLAT	T5	E9	5	--	1
			2	13361	BB, ●	69	6.0 / 600	10 / 1000	30	03 - 05	55504	CWH	4-FLAT		E17	10	56496	5
			2	14361	BB, ●	77	10 / 1000	12 / 1200	30	95 - 02	55329	CWH	4-FLAT		E11	5	--	1
			2.5	15704	BB, CF, ●	97	18 / 2700	18 / 2700	30	86 - 94	55317	CWH	4-FLAT		E8	5	--	1
	WITH OR WITHOUT FACTORY RECEIVER	03 - 10	2	15409	BB, CF, ●	89	17 / 2550	17 / 2550	30									
			2.5	15809	BB, CF, ●	99	20 / 2700	20 / 2700	30									
	EXCL. ROLL PAN BUMPER	68 - 02	2	13310	AA	35	6.0 / 600	10 / 1000	60									
			2	14001	AA	59	10 / 1000	12 / 1200	60									
			2	15300	BB, CF	67	16 / 2400	17 / 2400	60									
	6.5' BED, FACTORY BUMPER	99 - 02	2	15318	BB, CF	75	16 / 2400	17 / 2400	30									
8' BED, FACTORY BUMPER	94 - 02	2	15319	BB, CF	75	16 / 2400	17 / 2400	30										
6.5' OR 8' BED, FACTORY BUMPER	94 - 98	2	15318	BB, CF	75	16 / 2400	17 / 2400	30										

CUSTOM WIRING APPLICATION GUIDE FOOTNOTE KEY			For the most up-to-date application information, please visit curtmfg.com			
T1 Multiple parts available. Visit curtmfg.com	T5 Adds 4-flat to factory equipped 7-way	T9 Without factory tow package	T13 Excluding right hand drive	T17 Single rear wheels	T21 Excluding LTZ	
T2 Replaces factory connector with 4-flat	T6 Without LED taillights	T10 Hybrid only	T14 All wheel drive (AWD) models only	T18 SE models only	T22 Excluding plug-in models	
T3 Replaces factory connector with 6-way	T7 With LED taillights	T11 Excluding hybrid	T15 Excluding Grand Touring	T19 Excluding SE models	See page 33 for T23 - T63 footnote key comments	
T4 Replaces factory connector with 7-way	T8 With factory tow package	T12 Excluding EX and Limited	T16 WRX only	T20 Limited 2.0L and EX 2.0L models only	See page 33 for 'Electrical System Notes'	



TRAILER HITCHES

For 1.25" ordering options, see page 32

CUSTOM WIRING

No splicing required

CWH - For vehicles without OE tow package

ADD - Adds to OE tow package

REPL - Replacement for OE tow package

Splice-in Converters

Make / Model	Style / Notes	Years	Rec. Size	Part#	Foot Note	PC	GTW / TW	WD / WDTW	INS	No splicing required						Splice-in Converters		
										Years	Part#	Prod Type	Plug	FN	PC	INS	Part#	Sys. Note
DODGE (CONTINUED)																		
RAM 3500	EXCL. FACTORY RECEIVER	03 - 10	2	13333	K, ●	12	6.0 / 600	10 / 1000	30	00 - 10	55381	ADD	4-FLAT	T5	E9	5	--	1
			2	13361	BB, ●	69	6.0 / 600	10 / 1000	30	03 - 05	55504	CWH	4-FLAT		E17	10	56496	5
			2	14361	BB, ●	77	10 / 1000	12 / 1200	30	95 - 02	55329	CWH	4-FLAT		E11	5	--	1
			2.5	15704	BB, CF, ●	97	18 / 2700	18 / 2700	30	86 - 94	55317	CWH	4-FLAT		E8	5	--	1
	FITS WITH OR WITHOUT FACTORY RECEIVER	03 - 10	2	15409	BB, CF, ●	89	17 / 2550	17 / 2550	30									
			2.5	15809	BB, CF, ●	99	20 / 2700	20 / 2700	30									
	EXCL. ROLL PAN BUMPER	68 - 02	2	13310	AA	35	6.0 / 600	10 / 1000	60									
			2	14001	AA	59	10 / 1000	12 / 1200	60									
			2	15300	BB, CF	67	16 / 2400	17 / 2400	60									
	WITH FACTORY BUMPER	94 - 02	2	15319	BB, CF	75	16 / 2400	17 / 2400	30									
		94 - 98	2	15318	BB, CF	75	16 / 2400	17 / 2400	30									
	CAB & CHASSIS	07 - 10	2	14070	BB	49	10 / 1000	12 / 1200	45									
2			15400	BB, CF	83	17 / 2550	17 / 2550	30										
2.5			15800	BB, CF	88	20 / 2700	20 / 2700	30										
RAM 4500	--	08 - 10	2	14070	BB	49	10 / 1000	12 / 1200	45	--	--	--					--	--
			2	15400	BB, CF	83	17 / 2550	17 / 2550	30									
			2.5	15800	BB, CF	88	20 / 2700	20 / 2700	30									
RAM 5500	--	08 - 10	2	14070	BB	49	10 / 1000	12 / 1200	45	--	--	--					--	--
			2	15400	BB, CF	83	17 / 2550	17 / 2550	30									
			2.5	15800	BB, CF	88	20 / 2700	20 / 2700	30									
SPRINTER 2500	STANDARD BUMPER	07 - 09	2	13388	BB, ●	69	6.0 / 600	10 / 1000	30	03 - 09	55381	ADD	4-FLAT	T5	E9	5	56496	5
	STEP BUMPER	07 - 09	2	13358	BB, K, ●	69	5.0 / 500	7.5 / 750	30									
	118" AND 140" WB WITH SINGLE REAR WHEELS, 158" WB	03 - 06	2	13250	X	59	6.0 / 600	10 / 1000	45									
	CAB & CHASSIS, 170" WB	07 - 09	2	13275	AA, K	59	6.0 / 600	10 / 1000	30									
SPRINTER 3500	STANDARD BUMPER	07 - 09	2	13388	BB, ●	69	6.0 / 600	10 / 1000	30	03 - 09	55381	ADD	4-FLAT	T5	E9	5	56496	5
	144" WB WITH FACTORY STEP BUMPER	07 - 09	2	13375	BB, ●	63	5.0 / 500	7.5 / 750	30									
	170" WB WITH FACTORY STEP BUMPER	07 - 09	2	13358	BB, K, ●	69	5.0 / 500	7.5 / 750	30									
	118" AND 140" WB WITH SINGLE REAR WHEELS, 158" WB	03 - 06	2	13250	X	59	6.0 / 600	10 / 1000	45									
			2	14250	BB, X	75	10 / 1000	12 / 1200	45									
	CAB & CHASSIS, 170" WB	07 - 09	2	13275	AA, K	59	6.0 / 600	10 / 1000	30									
VAN (FULL SIZE)	EXCL. FACTORY STEP BUMPER	99 - 03	2	13015	●	45	6.0 / 600	10 / 1000	30	01 - 03	55381	ADD	4-FLAT	T5	E9	5	--	1
	WITH FACTORY STEP BUMPER	97 - 03	2	13590	●	51	5.0 / 500	8.0 / 800	30	99 - 00	55368	CWH	4-FLAT		E2	5	--	1
	EXCL. FACTORY STEP BUMPER	78 - 97	2	13041	●	61	6.0 / 600	10 / 1000	30	93 - 98	--	--					--	1
FIAT																		
500	EXCL. ABARTH	12 - 19	1.25	11363	BB, D, HE, V, ●	153	2.0 / 200	--	40	12 - 19	56174	CWH	4-FLAT		E28	45	56496	5
	ABARTH	12 - 19	1.25	11347	AA	169	2.0 / 200	--	30									
500L	ELECTRICAL INFO. ONLY	14 - 17	--	--	--	--	--	--		14 - 17	56193	CWH	4-FLAT	N	E28	45	56496	5
500X	EXCL. TREKKING	16 - 21	2	13271	BB, HE, M	37	3.5 / 525	--	45	16 - 18	56308	CWH	4-FLAT	N	E25	45	--	--
FORD																		
BRONCO	EXCL. FACTORY RECEIVER	21 - 24	2	13493	AA, ●	11.5	3.5 / 350	4.0 / 400	30	21 - 24	56468	CWH	4-FLAT	T7	E24	45	56496	5
	--	78 - 96	2	13310	AA	35	6.0 / 600	10 / 1000	60		56471	CWH	4-FLAT	T6	E25	45	56496	5
			2	14001	AA	59	10 / 1000	12 / 1200	60	92 - 96	55350	CWH	4-FLAT		E10	5	--	1
			2	15300	BB, CF	67	16 / 2400	17 / 2400	60	80 - 86	--	--					--	1
BRONCO SPORT	--	21 - 24	2	13474	AA, D, ●	49	3.5 / 525	--	45	21 - 24	56462	CWH	4-FLAT		E30	45	56236	6
C-MAX	--	13 - 18	1.25	12092	AA	135	3.5 / 350	--	30	13 - 16	--	--					56496	5
COUNTRY SQUIRE	--	87 - 91	1.25	12130	AA	155	3.5 / 350	--	30	87 - 91	--	--					--	1
			2	13707	AA	51	4.0 / 400	6.0 / 600	30									

TRAILER HITCH APPLICATION GUIDE FOOTNOTE KEY For the most up-to-date application information, please visit curtmfg.com

A Allow additional installation time	CC Roll pan mods required	F Will not fit vehicles with ground effects	HE Hole enlargement required	L Fixed draw bar	Q Temporary bumper removal	TG Compatible with Tommy Gate lifts	VT Vertical receiver tube
AA Main body concealed	CF Carbide black finish	FR Temporary bumper fascia removal	I Will not fit with full size spare	M Round tube main body	R Boxed due to bolt-on arms	U May require battery removal	W Only with boxed rear bumper
B Relocate or modify exhaust	D Minor fascia trim required	G Add'l install w/ load level air compressors	J No spare tire relocation	N Continued while supplies last	S May interfere hands free liftgate sensor	V Under-car trim (not fascia) req'd	● No drilling required
BB Main body exposed	E Noticeable fascia trim required	H Will not fit vehicles with twin tailpipes	K OEM-style hitch	P Not with roll pan bumper	T Modifications required (minor)	X 158" WB models require brace removal, 118" WB models require spare tire reloc.	



TRAILER HITCHES

For 1.25" ordering options, see page 32

CUSTOM WIRING

No splicing required

CWH - For vehicles without OE tow package

ADD - Adds to OE tow package

REPL - Replacement for OE tow package

Splice-in Converters

Make / Model	Style / Notes	Years	TRAILER HITCHES							CUSTOM WIRING									
			Rec. Size	Part#	Foot Note	PC	GTW / TW	WD / WDTW	INS	Years	Part#	Prod Type	Plug	FN	PC	INS	Part#	Sys. Note	
FORD (CONTINUED)																			
CROWN VICTORIA	--	92 - 11	1.25	12130	AA	155	3.5 / 350	--	30	92 - 97	55326	CWH	4-FLAT	E8	20	--	1		
			2	13707	AA	51	4.0 / 400	6.0 / 600	30										
ECONOLINE VAN	--	75 - 06	2	13053	BB, B, J	43	5.0 / 500	7.5 / 750	60	04 - 06	56020	CWH	4-FLAT	E12	15	--	1		
			2	14053	BB	69	10 / 1000	12 / 1200	60	95 - 03	55344	CWH	4-FLAT	E11	10	--	1		
E-TRANSIT	--	22 - 24	2	13193	BB, M, ●	29	6.0 / 900	8.0 / 900	30	22 - 24	56327	CWH	4-FLAT	E22	45	56236	2		
E-150	--	00 - 14	2	13055	M	43	6.0 / 600	8.0 / 800	35	04 - 14	56020	CWH	4-FLAT	E12	15	--	1		
			2	14055	BB	69	10 / 1000	12 / 1200	35	00 - 03	55344	CWH	4-FLAT	E11	10	--	1		
E-250	--	00 - 14	2	13055	M	43	6.0 / 600	8.0 / 800	35	04 - 14	56020	CWH	4-FLAT	E12	15	--	1		
			2	14055	BB	69	10 / 1000	12 / 1200	35	00 - 03	55344	CWH	4-FLAT	E11	10	--	1		
E-350 SUPER DUTY	--	00 - 14	2	13055	M	43	6.0 / 600	8.0 / 800	35	04 - 14	56020	CWH	4-FLAT	E12	15	--	1		
ECOSPORT	--	18 - 22	1.25	12188	B, E	145	3.5 / 350	--	30	--	--	--	--	--	--	--	--		
EDGE	--	15 - 24	1.25	12140	BB, M, V, ●	147	3.5 / 350	--	30	19 - 24	56436	CWH	4-FLAT	T31	E25	45	56496	5	
			2	13452	AA, FR, T, ●	45	4.5 / 675	4.5 / 675	45		56437	CWH	4-FLAT	T47	E25	45	56496	5	
			2	13234	BB, M, V	37	4.0 / 600	--	30	15 - 18	56292	CWH	4-FLAT	T30	E21	45	56496	5	
		EXCL. ECOBOOST	07 - 14	1.25	12036	BB, M, V	145	3.5 / 350	--	60		56272	CWH	4-FLAT	T31	E21	45	56496	5
		FITS BENEATH FACTORY 1-1/4" RECEIVER HITCH	07 - 14	2	13067	BB, D, V	46	4.0 / 400	--	60	11 - 14	56120	CWH	4-FLAT		E22	45	56496	5
ESCAPE	EXCL. PHEV	20 - 24	2	13454	AA, HE, ●	51	3.5 / 525	--	30	23 - 24	56507	CWH	4-FLAT		E27	45	56236	5	
			1.25	12111	AA, V	157	3.5 / 350	--	40			56503	REPL	4-FLAT	T2	E5	5	56236	5
	--	13 - 19	2	13186	AA, HE, V	56	3.5 / 350	5.0 / 500	40	20 - 22	56448	CWH	4-FLAT		E23	45	56236	5	
			2	13131	BB, HR, M, ●	47	3.5 / 525	5.0 / 525	30	19 - 19	56432	CWH	4-FLAT		E20	60	56496	5	
	EXCL. S	WITHOUT FACTORY 1-1/4" RECEIVER HITCH	05 - 12	1.25	12060	M	153	3.5 / 350	--	30	17 - 18	56320	CWH	4-FLAT	T19	E22	60	56496	5
				2	13650	M	47	3.5 / 350	5.0 / 500	30	13 - 16	56335	CWH	4-FLAT		E23	45	56496	5
	WITH FACTORY 1-1/4" RECEIVER HITCH	05 - 11	2	13651	BB, M	56	3.5 / 350	5.0 / 500	60	08 - 12	56329	CWH	4-FLAT		E22	45	56236	2	
			--	01 - 04	2	13506	M	46	3.5 / 350	5.0 / 500	30	05 - 07	56345	CWH	4-FLAT		E22	45	56236
											01 - 04	55255	REPL	4-FLAT	T2	E1	5	--	1
										00 - 03	55343	CWH	4-FLAT		E17	10	56496	4	
EXCURSION	--	00 - 05	2	14011	BB, ●	88	12 / 1200	12 / 1200	60	--	--	--	--	--	--	--	--		
EXPEDITION	--	97 - 02	2	13049	●	51	6.0 / 600	10 / 1000	30	97 - 03	55344	CWH	4-FLAT	E11	10	--	1		
			2	13125	M, ●	59	5.0 / 500	7.5 / 750	30										
EXPLORER	--	20 - 24	2	13438	AA, D, V, ●	39	6.0 / 600	--	60	20 - 24	56093	CWH	4-FLAT		E17	45	56496	5	
			2	13386	BB, M, ●	17	4.0 / 400	5.0 / 500	30	11 - 19	56306	CWH	7-WAY		E21	20	--	1	
	FITS BENEATH FACTORY 1-1/4" RECEIVER HITCH	06 - 10	2	13112	M, ●	46	5.0 / 500	8.0 / 800	30	11 - 19	56172	CWH	4-FLAT		E14	10	--	1	
			2	13550	M, ●	56	5.0 / 500	8.0 / 800	40	11 - 15	56278	CWH	7-WAY		E20	20	--	1	
	--	95 - 01	2	13033	I, ●	45	5.0 / 500	6.0 / 600	30	11 - 13	56093	CWH	4-FLAT		E17	45	56496	5	
			2	13540	M, ●	43	4.0 / 400	6.0 / 600	35	02 - 03	55344	CWH	4-FLAT		E11	10	--	1	
	--	91 - 94	2	13033	I	45	5.0 / 500	6.0 / 600	30	02 - 05	55251	REPL	4-FLAT	T2	E3	5	--	1	
2			13540	M	43	4.0 / 400	6.0 / 600	35	95 - 01	55345	CWH	4-FLAT		E20	40	56496	5		
										55241	REPL	4-FLAT	T2	E4	5	56496	5		
									91 - 94	--	--	--	--	--	--	--	1		
EXPLORER SPORT	--	01 - 03	2	13033	I, ●	45	5.0 / 500	6.0 / 600	30	01 - 03	55344	CWH	4-FLAT	E11	10	--	1		
			2	13540	M, ●	43	4.0 / 400	6.0 / 600	35										
EXPLORER SPORT TRAC	--	01 - 06	2	13407	M, ●	49	5.0 / 500	6.0 / 600	30	--	--	--	--	--	--	--	--		
F SUPER DUTY	CAB & CHASSIS WITH 34" FRAME WIDTH (O.D.)	88 - 97	2	13028	AA	45	6.0 / 600	10 / 1000	60	--	--	--	--	--	--	--	--		
			2	14082	AA	75	10 / 1000	12 / 1200	60										
F-100	EXCL. 10" DROP BUMPER, OLD BODY	73 - 83	2	13310	AA	35	6.0 / 600	10 / 1000	60	80 - 86	--	--	--	--	--	--	1		
			2	14001	AA	59	10 / 1000	12 / 1200	60										
			2	15300	BB, CF	67	16 / 2400	17 / 2400	60										
	WITH 10" DROP BUMPER, OLD BODY	80 - 83	2	13099	R	69	6.0 / 600	10 / 1000	60										

CUSTOM WIRING APPLICATION GUIDE FOOTNOTE KEY						For the most up-to-date application information, please visit curtmfg.com					
T1 Multiple parts available. Visit curtmfg.com	T5 Adds 4-flat to factory equipped 7-way	T9 Without factory tow package	T13 Excluding right hand drive	T17 Single rear wheels	T21 Excluding LTZ						
T2 Replaces factory connector with 4-flat	T6 Without LED taillights	T10 Hybrid only	T14 All wheel drive (AWD) models only	T18 SE models only	T22 Excluding plug-in models						
T3 Replaces factory connector with 6-way	T7 With LED taillights	T11 Excluding hybrid	T15 Excluding Grand Touring	T19 Excluding SE models	See page 33 for T23 - T63 footnote key comments						
T4 Replaces factory connector with 7-way	T8 With factory tow package	T12 Excluding EX and Limited	T16 WRX only	T20 Limited 2.0L and EX 2.0L models only	See page 33 for 'Electrical System Notes'						



TRAILER HITCHES

For 1.25" ordering options, see page 32

CUSTOM WIRING

No splicing required

CWH - For vehicles without OE tow package

ADD - Adds to OE tow package

REPL - Replacement for OE tow package

Splice-in Converters

Make / Model	Style / Notes	Years	TRAILER HITCHES							CUSTOM WIRING										
			Rec. Size	Part#	Foot Note	PC	GTW / TW	WD / WDTW	INS	Years	Part#	Prod Type	Plug	FN	PC	INS	Part#	Sys. Note		
FORD (CONTINUED)																				
F-150	EXCL. FACTORY RECEIVER OR POLICE RESPONDER	15 - 24	2	13475	BB, ●	37	6.0 / 900	10 / 1000	30	21 - 23	56465	CWH	4-WAY	T6, T52	E24	30	--	1		
			2	14017	AA, ●	59	10 / 1000	12 / 1200	30		56481	CWH	4-WAY	T7	E28	45	--	1		
	WITH FACTORY RECEIVER	15 - 24	2	14021	BB, ●	63	10 / 1000	12 / 1200	30		56486	CWH	4-WAY	T7, T52, T54	E24	45	--	1		
				2	13371	BB, M, ●	22	6.0 / 600	11 / 1100	30	15 - 20	56413	CWH	7-WAY		E22	20	--	1	
	EXCL. FACTORY RECEIVER	09 - 14	2	13368	BB, ●	14	6.0 / 600	11 / 1100	30	10 - 19	56110	REPL	4-FLAT		E6	10	--	1		
			2	14002	BB, ●	29	10 / 1000	12 / 1200	30	05 - 07	56031	CWH	4-FLAT		E11	10	--	1		
			2	13360	●	29	6.0 / 600	10 / 1000	30	04 - 04	55551	CWH	4-FLAT	N, T2	E11	10	--	1		
	EXCL. FACTORY RECEIVER (BUILT AFTER 8/5/05)	06 - 08	2	13365	M, ●	37	6.0 / 600	10 / 1000	30	97 - 03	55344	CWH	4-FLAT	T32	E11	10	--	1		
			2	14360	BB, ●	49	10 / 1000	12 / 1200	30		55242	ADD	7-WAY	T4	E19	5	--	1		
			2	13357	●	69	6.0 / 600	10 / 1000	30		55256	REPL	4-FLAT	T2	E11	5	--	1		
	EXCL. FACTORY RECEIVER AND 2004 HERITAGE EDITION	04 - 05	2	13352	M	49	6.0 / 600	10 / 1000	45		56031	CWH	4-FLAT	T33	E11	10	--	1		
			2	14357	BB, ●	88	10 / 1000	12 / 1200	30	87 - 96	55316	CWH	4-FLAT		E8	5	--	1		
	NEW BODY, EXCL. 20" SPARE TIRE	97 - 03	2	13038	●	37	6.0 / 600	10 / 1000	30	80 - 86	--	--					--	1		
	NEW BODY	97 - 03	2	13355	AA, K, ●	43	6.0 / 600	10 / 1000	30	73 - 79	55301	CWH	4-FLAT		E5	5	--	1		
			2	13359	M, ●	37	6.0 / 600	10 / 1000	30											
2			14355	AA, ●	69	10 / 1000	12 / 1200	30												
EXCL. 10" DROP BUMPER, OLD BODY	73 - 97	2	13310	AA	35	6.0 / 600	10 / 1000	60												
		2	14001	AA	59	10 / 1000	12 / 1200	60												
		2	15300	BB, CF	67	16 / 2400	17 / 2400	60												
WITH 10" DROP BUMPER, OLD BODY	63 - 97	2	13099	R	69	6.0 / 600	10 / 1000	60												
F-150 HERITAGE EDITION	EXCL. 20" SPARE TIRE	04 - 04	2	13038	●	37	6.0 / 600	10 / 1000	30	04 - 04	55242	ADD	7-WAY	T4	E19	5	--	1		
		04 - 04	2	13355	AA, K, ●	43	6.0 / 600	10 / 1000	30		55256	REPL	4-FLAT	T2	E11	5	--	1		
	2	13359	M, ●	37	6.0 / 600	10 / 1000	30	56031	CWH		4-FLAT	T33	E11	10	--	1				
	2	14355	AA, ●	69	10 / 1000	12 / 1200	30	55344	CWH		4-FLAT	T32	E11	10	--	1				
F-250	OLD BODY, EXCL. 10" DROP BUMPER AND 73 - 79 CREW CAB	73 - 99	2	13310	AA	35	6.0 / 600	10 / 1000	60	87 - 97	55316	CWH	4-FLAT		E8	5	--	1		
		2	14001	AA	59	10 / 1000	12 / 1200	60	80 - 86	--	--					--	1			
		2	15300	BB, CF	67	16 / 2400	17 / 2400	60	73 - 79	55301	CWH	4-FLAT		E5	5	--	1			
	OLD BODY WITH 10" DROP BUMPER, EXCL. 73 - 79 CREW CAB	63 - 97	2	13099	R	69	6.0 / 600	10 / 1000	60											
		75 - 79	2	13028	AA	45	6.0 / 600	10 / 1000	60											
2	14082	AA	75	10 / 1000	12 / 1200	60														
F-250LD	NEW BODY, EXCL. 20" SPARE TIRE	97 - 99	2	13038	●	37	6.0 / 600	10 / 1000	30	97 - 99	55344	CWH	4-FLAT	T32	E11	10	--	1		
		97 - 99	2	13355	AA, K, ●	43	6.0 / 600	10 / 1000	30					55242	ADD	7-WAY	T4	E19	5	--
	2	13359	M, ●	37	6.0 / 600	10 / 1000	30	55256	REPL					4-FLAT	T2	E11	5	--	1	
	2	14355	AA, ●	69	10 / 1000	12 / 1200	30													
F-250 SUPER DUTY	--	17 - 24	2.5	15802	BB, CF, ●	99	20 / 2700	20 / 2700	30	20 - 24	56443	REPL	7-WAY		E13	30	--	--		
	EXCL. 20" SPARE TIRE	99 - 16	2	13014	●	43	6.0 / 600	10 / 1000	30	03 - 07	56032	CWH	4-FLAT		E7	10	--	1		
	--	99 - 16	2	13355	AA, K, ●	43	6.0 / 600	10 / 1000	30	02 - 04	55265	REPL	4-FLAT	T2	E7	5	--	1		
			2	13359	M, ●	37	6.0 / 600	10 / 1000	30	99 - 01	55243	ADD	7-WAY	T4	E16	5	--	1		
			2	14355	AA, ●	69	10 / 1000	12 / 1200	30	55247	REPL	4-FLAT	N, T2	E6	5	--	1			
			2.5	15810	BB, CF, ●	83	17 / 2550	17 / 2550	30											
	WITH 16" SPARE TIRE AND 10" DROP BUMPER	99 - 03	2	15316	BB, CF, R, ●	88	16 / 2400	17 / 2400	30											

TRAILER HITCH APPLICATION GUIDE FOOTNOTE KEY

For the most up-to-date application information, please visit curtmfg.com

A Allow additional installation time	CC Roll pan mods required	F Will not fit vehicles with ground effects	HE Hole enlargement required	L Fixed draw bar	Q Temporary bumper removal	TG Compatible with Tommy Gate lifts	VT Vertical receiver tube
AA Main body concealed	CF Carbide black finish	FR Temporary bumper fascia removal	I Will not fit with full size spare	M Round tube main body	R Boxed due to bolt-on arms	U May require battery removal	W Only with boxed rear bumper
B Relocate or modify exhaust	D Minor fascia trim required	G Add'l install w/ load level air compressors	J No spare tire relocation	N Continued while supplies last	S May interfere hands free liftgate sensor	V Under-car trim (not fascia) req'd	● No drilling required
BB Main body exposed	E Noticeable fascia trim required	H Will not fit vehicles with twin tailpipes	K OEM-style hitch	P Not with roll pan bumper	T Modifications required (minor)	X 158" WB models require brace removal, 118" WB models require spare tire reloc.	



TRAILER HITCHES

For 1.25" ordering options, see page 32

CUSTOM WIRING

No splicing required

CWH - For vehicles without OE tow package

ADD - Adds to OE tow package

REPL - Replacement for OE tow package

Splice-in Converters

Make / Model	Style / Notes	Years	Rec. Size	Part#	Foot Note	PC	GTW / TW	WD / WDTW	INS	CUSTOM WIRING						Part#	Sys. Note				
										Years	Part#	Prod Type	Plug	FN	PC			INS			
FORD (CONTINUED)																					
F-350	OLD BODY, EXCL. WITH 10" DROP BUMPER	73 - 97	2	13310	AA	35	6.0 / 600	10 / 1000	60	87 - 97	55316	CWH	4-FLAT	E8	5	--	1				
			2	14001	AA	59	10 / 1000	12 / 1200	60	80 - 86	--	--				--	1				
			2	15300	BB, CF	67	16 / 2400	17 / 2400	60	73 - 79	55301	CWH	4-FLAT		E5	5	--	1			
	OLD BODY WITH 10" DROP BUMPER	63 - 97	2	13099	R	69	6.0 / 600	10 / 1000	60												
			CAB & CHASSIS WITH 34" FRAME WIDTH (O.D.)	73 - 97	2	13028	AA	45	6.0 / 600	10 / 1000	60										
					2	14082	AA	75	10 / 1000	12 / 1200	60										
F-350 SUPER DUTY	EXCL. CAB & CHASSIS	17 - 24	2.5	15802	BB, CF, ●	99	20 / 2700	20 / 2700	30	20 - 24	56443	REPL	7-WAY		E13	30	--	--			
			99 - 16	2	13355	AA, K, ●	43	6.0 / 600	10 / 1000	30	03 - 07	56032	CWH	4-FLAT		E7	10	--	1		
		2	13359	M, ●	37	6.0 / 600	10 / 1000	30	02 - 04	55265	REPL	4-FLAT	T2	E7	5	--	1				
			14355	AA, ●	69	10 / 1000	12 / 1200	30	99 - 01	55243	ADD	7-WAY	T4	E16	5	--	1				
			15410	BB, CF, ●	83	17 / 2550	17 / 2550	30		55247	REPL	4-FLAT	N, T2	E6	5	--	1				
			2.5	15810	BB, CF, ●	97	20 / 2700	20 / 2700	30												
	EXCL. CAB & CHASSIS AND 20" SPARE TIRE	99 - 16	2	13014	●	43	6.0 / 600	10 / 1000	30												
			WITH 16" SPARE TIRE AND 10" DROP BUMPER	99 - 03	2	15316	BB, CF, R, ●	88	16 / 2400	17 / 2400	30										
	CAB & CHASSIS WITH 34" FRAME WIDTH (O.D.)	20 - 25			2	14018	BB, CF, ●	77	10 / 1000	12 / 1200	20										
			2	15402	BB, CF, ●	97	17 / 2550	17 / 2550	20												
			2.5	15804	BB, CF, ●	97	20 / 2700	20 / 2700	20												
		99 - 20	2	14048	BB	65	10 / 1000	12 / 1200	40												
2			15445	BB, CF	97	17 / 2550	17 / 2550	30													
2.5			15845	BB, CF	89	20 / 2700	20 / 2700	30													
F-450 SUPER DUTY	EXCL. CAB & CHASSIS	17 - 24	2.5	15802	BB, CF, ●	99	20 / 2700	20 / 2700	30	20 - 24	56443	REPL	7-WAY		E13	30	--	--			
			08 - 16	2	13355	AA, K, ●	43	6.0 / 600	10 / 1000	30											
		2	13359	M, ●	37	6.0 / 600	10 / 1000	30													
			14355	AA, ●	69	10 / 1000	12 / 1200	30													
			15410	BB, CF, ●	83	17 / 2550	17 / 2550	30													
			2.5	15810	BB, CF, ●	97	20 / 2700	20 / 2700	30												
	CAB & CHASSIS WITH 34" FRAME WIDTH (O.D.)	99 - 25	2	14048	BB	65	10 / 1000	12 / 1200	40												
			2	15445	BB, CF	97	17 / 2550	17 / 2550	30												
	F-550 SUPER DUTY	CAB & CHASSIS WITH 34" FRAME WIDTH (O.D.)	99 - 25	2	14048	BB	65	10 / 1000	12 / 1200	40	20 - 24	56443	REPL	7-WAY		E13	30	--	--		
				2	15445	BB, CF	97	17 / 2550	17 / 2550	30											
				2.5	15845	BB, CF	89	20 / 2700	20 / 2700	30											
				F-650	CAB & CHASSIS WITH 34" FRAME WIDTH (O.D.)	00 - 25	2	14048	BB	65	10 / 1000	12 / 1200	40	20 - 24	56443	REPL	7-WAY		E13	30	--
2							15445	BB, CF	97	17 / 2550	17 / 2550	30									
2.5							15845	BB, CF	89	20 / 2700	20 / 2700	30									
FIESTA	HATCHBACK	11 - 19	1.25	11067	BB, M, V, ●	129	1.5 / 150	--	30	14 - 19	56191	CWH	4-FLAT		E14	20	56496	4			
			11 - 13	56064	CWH	4-FLAT		E17	40	56496	5										
	SEDAN	13 - 16	1.25	11369	AA, ●	145	2.0 / 200	--	30	14 - 19	56047	CWH	4-FLAT		E7	10	--	1			
										11 - 13	56114	CWH	4-FLAT	N, T2	E10	10	--	1			
FIVE HUNDRED	--	05 - 07	2	13542	AA, ●	51	3.5 / 350	4.0 / 400	30	05 - 07	55587	CWH	4-FLAT		E9	10	--	1			
FLEX	WITH DUAL EXHAUST	09 - 20	2	13110	BB, M, ●	61	4.0 / 400	4.0 / 400	40	09 - 19	56343	CWH	4-FLAT		E21	45	56236	2			
	WITHOUT DUAL EXHAUST	09 - 20	2	13551	BB, M	33	5.0 / 500	--	60												
FOCUS	COUPE	08 - 11	1.25	11319	AA, V, ●	149	2.0 / 200	--	40	08 - 11	56014	CWH	4-FLAT		E10	20	--	1			
	HATCHBACK, ST	13 - 18	1.25	11431	AA	145	2.0 / 200	--	30	15 - 18	56273	CWH	4-FLAT		E21	45	56496	5			
	HATCHBACK, EXCL. RS AND ST	12 - 18	1.25	11158	AA, HE	125	2.0 / 200	--	30	12 - 14	56140	CWH	4-FLAT		E23	45	56496	5			
	HATCHBACK, EXCL. SVT AND SAP	00 - 07	1.25	11294	BB	129	2.0 / 200	--	30												
	SEDAN	12 - 18	1.25	11158	AA, HE	125	2.0 / 200	--	30	12 - 18	56138	CWH	4-FLAT		E21	45	56496	5			
	SEDAN, EXCL. ST AND ELECTRIC	08 - 11	1.25	11319	AA, V, ●	149	2.0 / 200	--	40	07 - 11	56014	CWH	4-FLAT		E10	20	56496	5			
SEDAN, EXCL. SVT AND SAP	00 - 07	1.25	11294	BB	129	2.0 / 200	--	30	00 - 06	--	--					--	1				

CUSTOM WIRING APPLICATION GUIDE FOOTNOTE KEY						For the most up-to-date application information, please visit curtmfg.com					
T1 Multiple parts available. Visit curtmfg.com	T5 Adds 4-flat to factory equipped 7-way	T9 Without factory tow package	T13 Excluding right hand drive	T17 Single rear wheels	T21 Excluding LTZ						
T2 Replaces factory connector with 4-flat	T6 Without LED taillights	T10 Hybrid only	T14 All wheel drive (AWD) models only	T18 SE models only	T22 Excluding plug-in models						
T3 Replaces factory connector with 6-way	T7 With LED taillights	T11 Excluding hybrid	T15 Excluding Grand Touring	T19 Excluding SE models	See page 33 for T23 - T63 footnote key comments						
T4 Replaces factory connector with 7-way	T8 With factory tow package	T12 Excluding EX and Limited	T16 WRX only	T20 Limited 2.0L and EX 2.0L models only	See page 33 for 'Electrical System Notes'						



TRAILER HITCHES

For 1.25" ordering options, see page 32

CUSTOM WIRING

No splicing required

CWH - For vehicles without OE tow package

ADD - Adds to OE tow package

REPL - Replacement for OE tow package

Splice-in Converters

Make / Model	Style / Notes	Years	Rec. Size	Part#	Foot Note	PC	GTW / TW	WD / WDTW	INS	CUSTOM WIRING						Part#	Sys. Note	
										Years	Part#	Prod Type	Plug	FN	PC			INS
FORD (CONTINUED)																		
FREESTAR	--	04 - 07	2	13587	●	61	3.5 / 350	5.0 / 500	30	04 - 07	56329	CWH	4-FLAT	E22	45	56236	2	
											56073	REPL	4-FLAT	T2	E3	5	--	1
											56673	CWH	4-FLAT		E8	5	--	1
FREESTYLE	--	05 - 07	2	13542	AA, ●	51	3.5 / 350	4.0 / 400	30	05 - 07	55587	CWH	4-FLAT	E9	10	--	1	
FUSION	EXCL. SPORT	13 - 20	1.25	12091	AA, ●	125	3.5 / 350	--	30	13 - 20	56351	CWH	4-FLAT	E19	45	56236	2	
	SPORT	17 - 19	1.25	12164	AA, T, ●	155	3.5 / 350	--	30	06 - 12	56048	CWH	4-FLAT	E18	30	56496	2	
	--	10 - 12	1.25	11390	AA	137	2.0 / 200	--	30									
LTD	SEDAN	79 - 86	1.25	12130	AA	155	3.5 / 350	--	30	79 - 86	--	--				--	10	
				13707	AA	51	4.0 / 400	6.0 / 600	30									
				12130	AA	155	3.5 / 350	--	30	79 - 86	--	--						--
LTD CROWN VICTORIA	--	87 - 91	1.25	12130	AA	155	3.5 / 350	--	30	87 - 91	--	--				--	10	
				13707	AA	51	4.0 / 400	6.0 / 600	30									
MAVERICK	EXCL. FACTORY RECEIVER	22 - 24	2	13504	AA, V, ●	59	4.0 / 600	4.0 / 600	35	22 - 24	56477	CWH	4-FLAT	E23	45	56496	2	
MUSTANG	CONVERTIBLE, EXCL. SHELBY	15 - 15	1.25	11405	BB, ●	171	2.0 / 200	--	30	10 - 21	56088	CWH	4-FLAT	E18	40	56496	2	
	CONVERTIBLE, EXCL. CALIFORNIA SPECIAL	11 - 14	1.25	11210	AA, M, ●	125	2.0 / 200	--	30	05 - 09	--	--				--	1	
	CONVERTIBLE, EXCL. GT MODELS AND CALIFORNIA SPECIAL	11 - 11	1.25	11048	BB, M, ●	129	2.0 / 200	--	60	94 - 04	55326	CWH	4-FLAT	E8	20	--	1	
	CONVERTIBLE	10 - 10	1.25	11048	BB, M, ●	129	2.0 / 200	--	60									
	CONVERTIBLE, EXCL. GT	05 - 08	1.25	11312	AA, ●	137	2.0 / 200	--	30									
	CONVERTIBLE	94 - 04	1.25	11041	AA, H	145	2.0 / 200	--	30									
	COUPE, EXCL. MACH-1, SHELBY, ACTIVE EXHAUST, OR QUAD EXHAUST TIPS	15 - 23	1.25	11405	BB, ●	171	2.0 / 200	--	30	10 - 21	56088	CWH	4-FLAT	E18	40	56496	2	
	COUPE, EXCL. CALIFORNIA SPECIAL	11 - 14	1.25	11210	AA, M, ●	125	2.0 / 200	--	30	05 - 09	--	--				--	1	
	COUPE, EXCL. GT AND CALIFORNIA SPECIAL	11 - 11	1.25	11048	BB, M, ●	129	2.0 / 200	--	60	94 - 04	55326	CWH	4-FLAT	E8	20	--	1	
	COUPE	10 - 10	1.25	11048	BB, M, ●	129	2.0 / 200	--	60									
MUSTANG MACH-E	--	21 - 24	2	13480	AA, D, ●	55	2.0 / 200	--	60	21 - 24	--	--				56236	10	
				13386	BB, M, ●	17	4.0 / 400	5.0 / 500	30	13 - 18	56306	CWH	7-WAY	E21	20	--	1	
				56172	CWH	4-FLAT	E14	10	--	1								
POLICE INTERCEPTOR UTILITY	--	13 - 19	2	13386	BB, M, ●	17	4.0 / 400	5.0 / 500	30	13 - 18	56306	CWH	7-WAY	E21	20	--	1	
				56172	CWH	4-FLAT	E14	10	--	1								
RANGER	--	24 - 24	2	13607	AA, ●	13	7.5 / 750	8.0 / 800	30	24 - 24	--	--				--	1	
				13417	AA, ●	16	6.0 / 900	8.0 / 900	30	19 - 23	56431	CWH	7-WAY	E20	10	--	1	
				13287	AA, ●	61	4.0 / 400	6.0 / 600	30	11 - 11	56014	CWH	4-FLAT	E10	20	--	--	
				12012	BB	145	3.5 / 350	--	30	00 - 03	55344	CWH	4-FLAT	E11	10	--	1	
				13019	BB	29	4.0 / 400	6.0 / 600	30	93 - 99	55325	CWH	4-FLAT	E13	5	56496	5	
TAURUS	SEDAN	10 - 19	1.25	12296	AA, ●	153	3.5 / 300	--	30	10 - 19	56093	CWH	4-FLAT	T35	E17	45	56496	5
				13379	AA, HE, ●	55	4.0 / 400	--	30	00 - 03	--	--				--	1	
				13542	AA, ●	51	3.5 / 350	4.0 / 400	30									
				12232	●	161	3.5 / 300	--	30									
				12232	●	161	3.5 / 300	--	30	86 - 05	--	--						--
TRANSIT-150	--	15 - 24	2	13193	BB, M, ●	29	6.0 / 900	8.0 / 900	30	15 - 24	56327	CWH	4-FLAT	E22	45	56236	2	
				14012	AA, HE, ●	49	8.0 / 800	10 / 1000	30									
TRANSIT-250	--	15 - 24	2	13193	BB, M, ●	29	6.0 / 900	8.0 / 900	30	15 - 24	56327	CWH	4-FLAT	E22	45	56236	2	
				14012	AA, HE, ●	49	8.0 / 800	10 / 1000	30									

TRAILER HITCH APPLICATION GUIDE FOOTNOTE KEY

For the most up-to-date application information, please visit curtmfg.com

A Allow additional installation time	CC Roll pan mods required	F Will not fit vehicles with ground effects	HE Hole enlargement required	L Fixed draw bar	Q Temporary bumper removal	TG Compatible with Tommy Gate lifts	VT Vertical receiver tube
AA Main body concealed	CF Carbide black finish	FR Temporary bumper fascia removal	I Will not fit with full size spare	M Round tube main body	R Boxed due to bolt-on arms	U May require battery removal	W Only with boxed rear bumper
B Relocate or modify exhaust	D Minor fascia trim required	G Add'l install w/ load level air compressors	J No spare tire relocation	N Continued while supplies last	S May interfere hands free liftgate sensor	V Under-car trim (not fascia) req'd	● No drilling required
BB Main body exposed	E Noticeable fascia trim required	H Will not fit vehicles with twin tailpipes	K OEM-style hitch	P Not with roll pan bumper	T Modifications required (minor)	X 158" WB models require brace removal, 118" WB models require spare tire reloc.	



TRAILER HITCHES

For 1.25" ordering options, see page 32

CUSTOM WIRING

No splicing required

CWH - For vehicles without OE tow package

ADD - Adds to OE tow package

REPL - Replacement for OE tow package

Splice-in Converters

Make / Model	Style / Notes	Years	Rec. Size	Part#	Foot Note	PC	GTW / TW	WD / WDTW	INS	Years	Part#	Prod Type	Plug	FN	PC	INS	Part#	Sys. Note
FORD (CONTINUED)																		
TRANSIT-350	--	15 - 24	2	13193	BB, M, ●	29	6.0/900	8.0/900	30	15 - 24	56327	CWH	4-FLAT	T17	E22	45	56236	2
			2	14012	AA, HE, ●	49	8.0/800	10/1000	30									
TRANSIT CONNECT	--	14 - 23	1.25	12123	BB, M, ●	135	3.5/350	--	30	14 - 24	56218	CWH	4-FLAT		E21	45	56496	5
			2	13167	BB, M, ●	43	3.5/525	4.0/525	30									
		EXCL. ELECTRIC MODELS	10 - 13	1.25	12076	BB, M, ●	163	3.5/350	--	30	10 - 13	56090	CWH	4-FLAT		E25	45	56496
2	13076	BB, M, ●	46	3.5/350	4.0/400	30												
WINDSTAR	--	95 - 03	2	13085	AA	51	4.0/400	6.0/600	30	95 - 98	55346	CWH	4-FLAT	N	E17	20	--	9
FREIGHTLINER																		
SPRINTER	118" AND 140" WB WITH SINGLE REAR WHEELS, 158" WB	03 - 06	2	13250	X	59	6.0/600	10/1000	45	03 - 06	55381	ADD	4-FLAT	T5	E9	5	56496	5
			2	14250	BB, X	75	10/1000	12/1200	45									
SPRINTER 1500	STANDARD BUMPER	19 - 20	2	13388	BB, ●	69	6.0/600	10/1000	30	--	--	--					--	--
SPRINTER 2500	CARGO VAN WITH STANDARD BUMPER	07 - 21	2	13388	BB, ●	69	6.0/600	10/1000	30	10 - 21	--	--					56236	5
	CARGO VAN WITH FACTORY STEP BUMPER	07 - 21	2	13358	BB, K, ●	69	5.0/500	7.5/750	30	07 - 09	--	--					56496	5
SPRINTER 3500	CARGO VAN WITH STANDARD BUMPER	07 - 21	2	13388	BB, ●	69	6.0/600	10/1000	30	10 - 21	--	--					56236	5
	CARGO VAN, 144" WB WITH FACTORY STEP BUMPER	07 - 21	2	13375	BB, ●	63	5.0/500	7.5/750	30	07 - 09	--	--					56496	5
	CARGO VAN, 170" WB WITH FACTORY STEP BUMPER	07 - 21	2	13358	BB, K, ●	69	5.0/500	7.5/750	30									
	CAB & CHASSIS, 170" WB	07 - 16	2	13275	AA, K	59	6.0/600	10/1000	30									
GENESIS																		
G80	--	17 - 20	1.25	12165	BB, M, V	157	3.5/350	--	30	17 - 17	56264	CWH	4-FLAT		E17	45	56496	5
G90	--	17 - 19	1.25	12165	BB, M, V	157	3.5/350	--	30	--	--	--					--	--
GV80	--	21 - 25	2	13464	AA, ●	63	6.0/600	--	45	--	--	--					--	--
GEO																		
PRIZM	SEDAN	93 - 02	1.25	11181	AA, V	129	2.0/200	--	30	93 - 02	--	--					56496	4
TRACKER	--	99 - 05	2	13517	BB, ●	35	3.5/350	4.0/400	30	89 - 05	--	--					56496	4
		89 - 98	1.25	11128	BB, ●	129	2.0/200	--	30									
GMC																		
ACADIA	--	24 - 24	2	13614	AA, FR, Q, ●	39	5.0/500	5.0/500	120	24 - 24	56538	CWH	4-FLAT		E10	20	--	1
	EXCL. AT4	17 - 23	2	13293	BB, M, V, ●	35	5.0/750	--	30		56537	CWH	7-WAY		E18	20	--	--
	--	07 - 16	2	13424	AA, ●	25	5.0/500	6.0/600	30	17 - 23	56325	CWH	4-FLAT		E4	10	--	1
											56326	CWH	7-WAY		E18	10	--	1
										13 - 16	56245	REPL	4-FLAT	T2	E11	20	56496	2
ACADIA LIMITED	--	17 - 17	2	13424	AA, ●	25	5.0/500	6.0/600	30	07 - 12	56056	CWH	4-FLAT		E12	15	--	1
C15	WITH 10" STEP BUMPER	75 - 87	2	13099	J, R	69	6.0/600	10/1000	60	17 - 17	56245	REPL	4-FLAT	T2	E11	20	56496	2
	EXCL. 10" STEP BUMPER	75 - 87	2	13028	AA	45	6.0/600	10/1000	60	85 - 87	55312	CWH	4-FLAT		E5	5	--	1
				2	14082	AA	75	10/1000	12/1200	60	75 - 84	55311	CWH	4-FLAT		E5	5	--
C1500	EXCL. DUAL EXHAUST OR 10" STEP BUMPER	88 - 99	2	13082	BB, K, ●	46	6.0/600	10/1000	30	88 - 99	55315	CWH	4-FLAT		E5	5	--	1
			2	14081	AA, ●	59	10/1000	12/1200	30									
			2	15325	BB, CF, R, ●	87	16/2400	17/2400	60									
	WITH DUAL EXHAUST	88 - 99	2	13042	●	43	6.0/600	10/1000	30									
	WITH ROLL PAN BUMPER	88 - 99	2	13942	CC, ●	45	5.0/500	8.0/800	30									
WITH 10" STEP BUMPER	88 - 99	2	13099	J, R	69	6.0/600	10/1000	60										
C25	WITH 10" STEP BUMPER	75 - 78	2	13099	J, R	69	6.0/600	10/1000	60	75 - 78	55311	CWH	4-FLAT		E5	5	--	1
	EXCL. WITH 10" STEP BUMPER	75 - 78	2	13028	AA	45	6.0/600	10/1000	60									
				2	14082	AA	75	10/1000	12/1200	60								
	CAB & CHASSIS	75 - 78	2	13028	AA	45	6.0/600	10/1000	60									
			2	14082	AA	75	10/1000	12/1200	60									

CUSTOM WIRING APPLICATION GUIDE FOOTNOTE KEY						For the most up-to-date application information, please visit curtmfg.com					
T1 Multiple parts available. Visit curtmfg.com	T5 Adds 4-flat to factory equipped 7-way	T9 Without factory tow package	T13 Excluding right hand drive	T17 Single rear wheels	T21 Excluding LTZ						
T2 Replaces factory connector with 4-flat	T6 Without LED taillights	T10 Hybrid only	T14 All wheel drive (AWD) models only	T18 SE models only	T22 Excluding plug-in models						
T3 Replaces factory connector with 6-way	T7 With LED taillights	T11 Excluding hybrid	T15 Excluding Grand Touring	T19 Excluding SE models	See page 33 for T23 - T63 footnote key comments						
T4 Replaces factory connector with 7-way	T8 With factory tow package	T12 Excluding EX and Limited	T16 WRX only	T20 Limited 2.0L and EX 2.0L models only	See page 33 for 'Electrical System Notes'						



TRAILER HITCHES

For 1.25" ordering options, see page 32

CUSTOM WIRING

No splicing required

CWH - For vehicles without OE tow package

ADD - Adds to OE tow package

REPL - Replacement for OE tow package

Splice-in Converters

Make / Model	Style / Notes	Years	TRAILER HITCHES							CUSTOM WIRING						Part#	Sys. Note
			Rec. Size	Part#	Foot Note	PC	GTW / TW	WD / WDTW	INS	Years	Part#	Prod Type	Plug	FN	PC		
GMC (CONTINUED)																	
C2500	EXCL. WITH DUAL EXHAUST, 10" STEP BUMPER OR CAB & CHASSIS	88 - 00	2	13082	BB, K, ●	46	6.0 / 600	10 / 1000	30	88 - 00	55315	CWH	4-FLAT	E5	5	--	1
			2	14081	AA, ●	59	10 / 1000	12 / 1200	30	79 - 84	55311	CWH	4-FLAT	E5	5	--	1
			2	15325	BB, CF, R, ●	87	16 / 2400	17 / 2400	60								
		79 - 86	2	13028	AA	45	6.0 / 600	10 / 1000	60								
			2	14082	AA	75	10 / 1000	12 / 1200	60								
			2	13042	●	43	6.0 / 600	10 / 1000	30								
	WITH 10" STEP BUMPER	88 - 00	2	13042	●	43	6.0 / 600	10 / 1000	30								
		79 - 00	2	13099	J, R	69	6.0 / 600	10 / 1000	60								
	CAB & CHASSIS	79 - 00	2	15317	BB, CF, R, ●	94	16 / 2400	17 / 2400	30								
			2	13028	AA	45	6.0 / 600	10 / 1000	60								
			2	14082	AA	75	10 / 1000	12 / 1200	60								
C35	WITH 10" STEP BUMPER	75 - 78	2	13099	J, R	69	6.0 / 600	10 / 1000	60	75 - 78	55311	CWH	4-FLAT	E5	5	--	1
	EXCL. WITH 10" STEP BUMPER	75 - 78	2	13028	AA	45	6.0 / 600	10 / 1000	60								
			2	14082	AA	75	10 / 1000	12 / 1200	60								
	CAB & CHASSIS	75 - 78	2	13028	AA	45	6.0 / 600	10 / 1000	60								
			2	14082	AA	75	10 / 1000	12 / 1200	60								
	C3500	EXCL. WITH DUAL EXHAUST, 10" STEP BUMPER OR CAB & CHASSIS	88 - 00	2	13082	BB, K, ●	46	6.0 / 600	10 / 1000	30	88 - 00	55315	CWH	4-FLAT	E5	5	--
2				14081	AA, ●	59	10 / 1000	12 / 1200	30	79 - 84	55311	CWH	4-FLAT	E5	5	--	1
2				15325	BB, CF, R, ●	87	16 / 2400	17 / 2400	60								
79 - 86			2	13028	AA	45	6.0 / 600	10 / 1000	60								
			2	14082	AA	75	10 / 1000	12 / 1200	60								
			2	13042	●	43	6.0 / 600	10 / 1000	30								
WITH 10" STEP BUMPER		79 - 00	2	13099	J, R	69	6.0 / 600	10 / 1000	60								
CAB & CHASSIS		79 - 00	2	15317	BB, CF, R, ●	94	16 / 2400	17 / 2400	30								
			2	13028	AA	45	6.0 / 600	10 / 1000	60								
				2	14082	AA	75	10 / 1000	12 / 1200	60							
C3500HD	CAB & CHASSIS	91 - 02	2	13028	AA	45	6.0 / 600	10 / 1000	60	--	--	--				--	--
			2	14082	AA	75	10 / 1000	12 / 1200	60								
CANYON	--	23 - 24	2	13576	AA, Q, ●	45	8.0 / 800	10 / 1000	60	04 - 12	55510	CWH	4-FLAT	E12	10	56496	5
		15 - 22	2	13203	AA, M, Q, T, ●	37	6.0 / 900	8.0 / 900	30								
			2	13176	AA, N, T, ●	43	8.0 / 800	10 / 1000	30								
		04 - 12	2	13252	BB, M, ●	35	4.0 / 400	6.0 / 600	30								
G-SERIES VAN	--	78 - 96	2	13016	●	61	6.0 / 600	10 / 1000	40	87 - 95	55338	CWH	4-FLAT	E7	10	--	1
JIMMY	FULL SIZE	92 - 94	2	13029	BB, HE, ●	39	6.0 / 600	10 / 1000	30	92 - 94	55319	CWH	4-FLAT	E5	5	--	1
			2	14029	BB, HE, ●	63	10 / 1000	12 / 1200	30	85 - 91	55312	CWH	4-FLAT	E5	5	--	1
			2	13121	M, ●	46	5.0 / 500	6.0 / 600	30	73 - 84	55311	CWH	4-FLAT	E5	5	--	1
			2	13401	AA	53	5.0 / 500	10 / 1000	30	95 - 02	55411	CWH	4-FLAT	E2	15	--	1
	DOWN SIZE	95 - 04	2	13020	●	37	5.0 / 500	6.0 / 600	30								
			2	13300	M, ●	43	4.0 / 400	6.0 / 600	30								
			2	13083	●	65	5.0 / 500	6.0 / 600	30								
			83 - 94	2	13083	●	65	5.0 / 500	6.0 / 600	30							
ENVOY	--	99 - 00	2	13020	●	37	5.0 / 500	6.0 / 600	30	99 - 01	55411	CWH	4-FLAT	E2	15	--	1
			2	13300	M, ●	43	4.0 / 400	6.0 / 600	30								
K15	WITH 10" STEP BUMPER	75 - 87	2	13099	J, R	69	6.0 / 600	10 / 1000	60	85 - 87	55312	CWH	4-FLAT	E5	5	--	1
	EXCL. 10" STEP BUMPER	75 - 87	2	13028	AA	45	6.0 / 600	10 / 1000	60	75 - 84	55311	CWH	4-FLAT	E5	5	--	1
			2	14082	AA	75	10 / 1000	12 / 1200	60								
K1500	EXCL. DUAL EXHAUST OR 10" STEP BUMPER OR	88 - 99	2	13082	BB, K, ●	46	6.0 / 600	10 / 1000	30	88 - 99	55315	CWH	4-FLAT	E5	5	--	1
			2	14081	AA, ●	59	10 / 1000	12 / 1200	30								
			2	15325	BB, CF, R, ●	87	16 / 2400	17 / 2400	60								
	WITH DUAL EXHAUST	88 - 99	2	13042	●	43	6.0 / 600	10 / 1000	30								
	WITH ROLL PAN BUMPER	88 - 99	2	13942	CC, ●	45	5.0 / 500	8.0 / 800	30								
	WITH 10" STEP BUMPER	88 - 99	2	13099	J, R	69	6.0 / 600	10 / 1000	60								

TRAILER HITCH APPLICATION GUIDE FOOTNOTE KEY				For the most up-to-date application information, please visit curtmfg.com			
A Allow additional installation time	CC Roll pan mods required	F Will not fit vehicles with ground effects	HE Hole enlargement required	L Fixed draw bar	Q Temporary bumper removal	TG Compatible with Tommy Gate lifts	VT Vertical receiver tube
AA Main body concealed	CF Carbide black finish	FR Temporary bumper fascia removal	I Will not fit with full size spare	M Round tube main body	R Boxed due to bolt-on arms	U May require battery removal	W Only with boxed rear bumper
B Relocate or modify exhaust	D Minor fascia trim required	G Add'l install w/ load level air compressors	J No spare tire relocation	N Continued while supplies last	S May interfere hands free liftgate sensor	V Under-car trim (not fascia) req'd	● No drilling required
BB Main body exposed	E Noticeable fascia trim required	H Will not fit vehicles with twin tailpipes	K OEM-style hitch	P Not with roll pan bumper	T Modifications required (minor)	X 158" WB models require brace removal, 118" WB models require spare tire reloc.	



TRAILER HITCHES

For 1.25" ordering options, see page 32

CUSTOM WIRING

No splicing required

CWH - For vehicles without OE tow package

ADD - Adds to OE tow package

REPL - Replacement for OE tow package

Splice-in Converters

Make / Model	Style / Notes	Years	Rec. Size	Part#	Foot Note	PC	GTW / TW	WD / WDTW	INS	CUSTOM WIRING						Part#	Sys. Note
										Years	Part#	Prod Type	Plug	FN	PC		
GMC (CONTINUED)																	
K25	WITH 10" STEP BUMPER	75 - 78	2	13099	J, R	69	6.0 / 600	10 / 1000	60	75 - 78	55311	CWH	4-FLAT	E5	5	--	1
	EXCL. WITH 10" STEP BUMPER	75 - 78	2	13028	AA	45	6.0 / 600	10 / 1000	60								
	CAB & CHASSIS	75 - 78	2	14082	AA	75	10 / 1000	12 / 1200	60								
			2	13028	AA	45	6.0 / 600	10 / 1000	60								
K2500	EXCL. WITH DUAL EXHAUST, 4-DOOR CREW CAB, 10" STEP BUMPER OR CAB & CHASSIS	88 - 00	2	13082	BB, K, ●	46	6.0 / 600	10 / 1000	30	88 - 00	55315	CWH	4-FLAT	E5	5	--	1
			2	14081	AA, ●	59	10 / 1000	12 / 1200	30	79 - 84	55311	CWH	4-FLAT	E5	5	--	1
		79 - 86	2	15325	BB, CF, R, ●	87	16 / 2400	17 / 2400	60								
			2	13028	AA	45	6.0 / 600	10 / 1000	60								
	WITH DUAL EXHAUST 4-DOOR CREW CAB	88 - 91	2	13042	●	43	6.0 / 600	10 / 1000	30								
			2	13028	AA	45	6.0 / 600	10 / 1000	60								
	WITH 10" STEP BUMPER	88 - 00	2	14082	AA	75	10 / 1000	12 / 1200	60								
			2	13099	J, R	69	6.0 / 600	10 / 1000	60								
	CAB & CHASSIS	79 - 00	2	15317	BB, CF, R, ●	94	16 / 2400	17 / 2400	30								
			2	13028	AA	45	6.0 / 600	10 / 1000	60								
		79 - 00	2	14082	AA	75	10 / 1000	12 / 1200	60								
K35	WITH 10" STEP BUMPER	75 - 78	2	13099	J, R	69	6.0 / 600	10 / 1000	60	75 - 78	55311	CWH	4-FLAT	E5	5	--	1
	EXCL. WITH 10" STEP BUMPER	75 - 78	2	13028	AA	45	6.0 / 600	10 / 1000	60								
	CAB & CHASSIS	75 - 78	2	14082	AA	75	10 / 1000	12 / 1200	60								
			2	13028	AA	45	6.0 / 600	10 / 1000	60								
K3500	EXCL. WITH DUAL EXHAUST, 4-DOOR CREW CAB, 10" STEP BUMPER OR CAB & CHASSIS	88 - 00	2	13082	BB, K, ●	46	6.0 / 600	10 / 1000	30	88 - 00	55315	CWH	4-FLAT	E5	5	--	1
			2	14081	AA, ●	59	10 / 1000	12 / 1200	30	79 - 84	55311	CWH	4-FLAT	E5	5	--	1
		79 - 86	2	15325	BB, CF, R, ●	87	16 / 2400	17 / 2400	60								
			2	13028	AA	45	6.0 / 600	10 / 1000	60								
	WITH DUAL EXHAUST 4-DOOR CREW CAB	88 - 91	2	13042	●	43	6.0 / 600	10 / 1000	30								
			2	13028	AA	45	6.0 / 600	10 / 1000	60								
	WITH 10" STEP BUMPER	88 - 00	2	14082	AA	75	10 / 1000	12 / 1200	60								
			2	13099	J, R	69	6.0 / 600	10 / 1000	60								
	CAB & CHASSIS	79 - 00	2	15317	BB, CF, R, ●	94	16 / 2400	17 / 2400	30								
			2	13028	AA	45	6.0 / 600	10 / 1000	60								
		79 - 00	2	14082	AA	75	10 / 1000	12 / 1200	60								
SAVANA 1500	--	96 - 14	2	13040	BB, ●	33	6.0 / 600	10 / 1000	30	03 - 14	55540	CWH	4-FLAT	E10	20	--	1
			2	14090	BB, ●	56	10 / 1000	12 / 1200	30	00 - 02	55377	CWH	4-FLAT	E15	10	56496	4
			2	15320	BB, CF, ●	71	16 / 2400	17 / 2400	30	96 - 99	55335	CWH	4-FLAT	E15	20	56496	4
			2	15320	BB, CF, ●	71	16 / 2400	17 / 2400	30	96 - 03	55240	REPL	4-FLAT	E2	5	56496	4
SAVANA 2500	--	96 - 24	2	13040	BB, ●	33	6.0 / 600	10 / 1000	30	03 - 24	55540	CWH	4-FLAT	E10	20	--	1
			2	14090	BB, ●	56	10 / 1000	12 / 1200	30	00 - 02	55377	CWH	4-FLAT	E15	10	56496	4
			2	15320	BB, CF, ●	71	16 / 2400	17 / 2400	30	96 - 99	55335	CWH	4-FLAT	E15	20	56496	4
			2	15320	BB, CF, ●	71	16 / 2400	17 / 2400	30	96 - 03	55240	REPL	4-FLAT	E2	5	56496	4
SAVANA 3500	EXCL. CUTAWAY MODELS	96 - 24	2	13040	BB, ●	33	6.0 / 600	10 / 1000	30	03 - 24	55540	CWH	4-FLAT	E10	20	--	1
			2	14090	BB, ●	56	10 / 1000	12 / 1200	30	00 - 02	55377	CWH	4-FLAT	E15	10	56496	4
			2	15320	BB, CF, ●	71	16 / 2400	17 / 2400	30	96 - 99	55335	CWH	4-FLAT	E15	20	56496	4
			2	15320	BB, CF, ●	71	16 / 2400	17 / 2400	30	96 - 03	55240	REPL	4-FLAT	E2	5	56496	4
S15	--	82 - 90	1.25	12011	●	145	3.5 / 350	6.0 / 600	45	98 - 04	55359	CWH	4-FLAT	E7	5	--	1
			2	13132	AA, M, P, ●	45	4.0 / 400	6.0 / 600	45	85 - 97	55312	CWH	4-FLAT	E5	5	--	1
			2	13021	AA, P, Q, ●	45	4.0 / 400	6.0 / 600	45								
			2	13920	A, D	56	3.5 / 350	5.0 / 500	60								
SAFARI	16" SPARE REQUIRES RELOCATION	85 - 05	2	13035	AA, R, ●	49	4.0 / 400	6.0 / 600	45	95 - 05	55411	CWH	4-FLAT	E2	15	--	1

CUSTOM WIRING APPLICATION GUIDE FOOTNOTE KEY			For the most up-to-date application information, please visit curtmfg.com			
T1 Multiple parts available. Visit curtmfg.com	T5 Adds 4-flat to factory equipped 7-way	T9 Without factory tow package	T13 Excluding right hand drive	T17 Single rear wheels	T21 Excluding LTZ	
T2 Replaces factory connector with 4-flat	T6 Without LED taillights	T10 Hybrid only	T14 All wheel drive (AWD) models only	T18 SE models only	T22 Excluding plug-in models	
T3 Replaces factory connector with 6-way	T7 With LED taillights	T11 Excluding hybrid	T15 Excluding Grand Touring	T19 Excluding SE models	See page 33 for T23 - T63 footnote key comments	
T4 Replaces factory connector with 7-way	T8 With factory tow package	T12 Excluding EX and Limited	T16 WRX only	T20 Limited 2.0L and EX 2.0L models only	See page 33 for 'Electrical System Notes'	



TRAILER HITCHES

For 1.25" ordering options, see page 32

CUSTOM WIRING

No splicing required

CWH - For vehicles without OE tow package

ADD - Adds to OE tow package

REPL - Replacement for OE tow package

Splice-in
Converters

Make / Model	Style / Notes	Years	Rec. Size	Part#	Foot Note	PC	GTW / TW	WD / WDTW	INS	CUSTOM WIRING						Part#	Sys. Note
										Years	Part#	Prod Type	Plug	FN	PC		
GMC (CONTINUED)																	
SIERRA 1500	EXCL. FACTORY RECEIVER	19 - 25	2	13393	AA, ●	35	6.0 / 600	10 / 1000	60	--	--	--				--	--
			2	14019	BB, ●	79	10 / 1000	12 / 1200	60								
	WITH FACTORY RECEIVER	14 - 18	2	15307	BB, CF, ●	88	16 / 2000	17 / 2000	75								
				2	13175	AA, ●	45	6.0 / 600	10 / 1000	30							
			2	07 - 18	14006	AA, ●	49	10 / 1000	12 / 1200	30							
					2	13301	T, ●	29	6.0 / 600	10 / 1000	30						
			2	99 - 13	14301	AA, ●	49	10 / 1000	12 / 1200	30							
					2	13322	BB, D, M, ●	35	6.0 / 600	10 / 1000	30						
			2	99 - 06	15323	BB, CF, ●	83	16 / 2400	17 / 2400	30							
					2	13332	AA, K, ●	37	6.0 / 600	10 / 1000	30						
2	14332	AA, ●	67	10 / 1000	12 / 1200	30											
2	13932	AA, CC, ●	43	5.0 / 500	8.0 / 800	30											
2	13339	TG, ●	56	8.0 / 800	12 / 1200	30											
SIERRA 1500 CLASSIC	EXCL. ROLL PAN BUMPER, TOMMY GATE LIFT OR 10" DROP BUMPER	07 - 07	2	13322	BB, D, M, ●	35	6.0 / 600	10 / 1000	30	--	--	--				--	--
			2	13332	AA, K, ●	37	6.0 / 600	10 / 1000	30								
			2	14332	AA, ●	67	10 / 1000	12 / 1200	30								
			2	15323	BB, CF, ●	83	16 / 2400	17 / 2400	30								
	2	13932	AA, CC, ●	43	5.0 / 500	8.0 / 800	30										
	2	13339	TG, ●	56	8.0 / 800	12 / 1200	30										
SIERRA 1500 HD	EXCL. 10" DROP BUMPER, ROLL PAN BUMPER OR TOMMY GATE LIFT	01 - 06	2	13322	BB, D, M, ●	35	6.0 / 600	10 / 1000	30	--	--	--				--	--
			2	13332	AA, K, ●	37	6.0 / 600	10 / 1000	30								
			2	14332	AA, ●	67	10 / 1000	12 / 1200	30								
			2	15323	BB, CF, ●	83	16 / 2400	17 / 2400	30								
	2	13932	AA, CC, ●	43	5.0 / 500	8.0 / 800	30										
	2	13339	TG, ●	56	8.0 / 800	12 / 1200	30										
SIERRA 1500 HD CLASSIC	EXCL. ROLL PAN BUMPER, TOMMY GATE LIFT OR 10" DROP BUMPER	07 - 07	2	13322	BB, D, M, ●	35	6.0 / 600	10 / 1000	30	--	--	--				--	--
			2	13332	AA, K, ●	37	6.0 / 600	10 / 1000	30								
			2	14332	AA, ●	67	10 / 1000	12 / 1200	30								
			2	15323	BB, CF, ●	83	16 / 2400	17 / 2400	30								
	2	13932	AA, CC, ●	43	5.0 / 500	8.0 / 800	30										
	2	13339	TG, ●	56	8.0 / 800	12 / 1200	30										
SIERRA 1500 LIMITED	EXCL. FACTORY RECEIVER	22 - 22	2	13393	AA, ●	35	6.0 / 600	10 / 1000	60	--	--	--				--	--
			2	14019	BB, ●	79	10 / 1000	12 / 1200	60								
	WITH FACTORY RECEIVER	19 - 19	2	15307	BB, CF, ●	88	16 / 2000	17 / 2000	75								
				2	13175	AA, ●	45	6.0 / 600	10 / 1000	30							
			2	07 - 18	14006	AA, ●	49	10 / 1000	12 / 1200	30							
					2	13301	T, ●	29	6.0 / 600	10 / 1000	30						
			2	99 - 13	14301	AA, ●	49	10 / 1000	12 / 1200	30							
					2	13322	BB, D, M, ●	35	6.0 / 600	10 / 1000	30						
SIERRA 2500	EXCL. TOMMY GATE LIFT, 10" DROP BUMPER OR CAB & CHASSIS	99 - 04	2	13322	BB, D, M, ●	35	6.0 / 600	10 / 1000	30	--	--	--				--	--
			2	13332	AA, K, ●	37	6.0 / 600	10 / 1000	30								
			2	14332	AA, ●	67	10 / 1000	12 / 1200	30								
			2	15323	BB, CF, ●	83	16 / 2400	17 / 2400	30								
	2	99 - 04	13339	TG, ●	56	8.0 / 800	12 / 1200	30									
			99 - 99	2	13028	AA	45	6.0 / 600	10 / 1000	60							
2	14082	AA		75	10 / 1000	12 / 1200	60										
2	15400	BB, CF		83	17 / 2550	17 / 2550	30										
2.5	15800	BB, CF	88	20 / 2700	20 / 2700	30											

TRAILER HITCH APPLICATION GUIDE FOOTNOTE KEY				For the most up-to-date application information, please visit curtmfg.com			
A Allow additional installation time	CC Roll pan mods required	F Will not fit vehicles with ground effects	HE Hole enlargement required	L Fixed draw bar	Q Temporary bumper removal	TG Compatible with Tommy Gate lifts	VT Vertical receiver tube
AA Main body concealed	CF Carbide black finish	FR Temporary bumper fascia removal	I Will not fit with full size spare	M Round tube main body	R Boxed due to bolt-on arms	U May require battery removal	W Only with boxed rear bumper
B Relocate or modify exhaust	D Minor fascia trim required	G Add'l install w/ load level air compressors	J No spare tire relocation	N Continued while supplies last	S May interfere hands free liftgate sensor	V Under-car trim (not fascia) req'd	● No drilling required
BB Main body exposed	E Noticeable fascia trim required	H Will not fit vehicles with twin tailpipes	K OEM-style hitch	P Not with roll pan bumper	T Modifications required (minor)	X 158" WB models require brace removal, 118" WB models require spare tire reloc.	



TRAILER HITCHES

For 1.25" ordering options, see page 32

CUSTOM WIRING

No splicing required

CWH - For vehicles without OE tow package

ADD - Adds to OE tow package

REPL - Replacement for OE tow package

Splice-in Converters

Make / Model	Style / Notes	Years	Rec. Size	Part#	Foot Note	PC	GTW / TW	WD / WDTW	INS	CUSTOM WIRING						Part#	Sys. Note			
										Years	Part#	Prod Type	Plug	FN	PC			INS		
GMC (CONTINUED)																				
SIERRA 2500 HD	6' BED, EXCL. FACTORY RECEIVER, TOMMY GATE LIFT OR CAB & CHASSIS	20 - 25	2	13447	BB, ●	88	8.0 / 800	12 / 1200	30	--	--	--					--	--		
			2	14005	BB, ●	89	10 / 1000	12 / 1200	30											
			2	15007	BB, ●	97	17 / 2550	17 / 2550	30											
		2.5	15010	BB, ●	97	20 / 2700	20 / 2700	30												
		15 - 19	2	13178	AA, ●	56	8.0 / 800	12 / 1200	30											
			2	14009	AA, ●	63	10 / 1000	12 / 1200	30											
		11 - 19	2	15460	BB, CF	97	17 / 2550	17 / 2550	45											
			2.5	15860	BB, CF	99	20 / 2700	20 / 2700	45											
		11 - 14	2	13062	BB, ●	55	8.0 / 800	12 / 1200	30											
			2	14062	BB, ●	65	10 / 1000	12 / 1200	30											
		01 - 10	2	13208	D, ●	71	8.0 / 800	12 / 1200	40											
			2	13210	D, ●	63	6.0 / 600	10 / 1000	30											
			2	13211	BB, M, ●	63	6.0 / 600	10 / 1000	30											
			2	14211	AA, D	85	10 / 1000	12 / 1200	40											
			2.5	15703	BB, CF, ●	89	18 / 2700	18 / 2700	30											
	01 - 06	2	13108	AA, ●	45	6.0 / 600	10 / 1000	30												
		2	14108	AA, ●	71	10 / 1000	12 / 1200	30												
	01 - 10	6' BED, FACTORY REPL. HITCH	2	15302	AA, CF, K, ●	79	16 / 2400	17 / 2400	30											
	SIERRA 2500 HD CLASSIC	8' BED, EXCL. FACTORY RECEIVER, TOMMY GATE LIFT OR CAB & CHASSIS	20 - 25	2	13447	BB, ●	88	8.0 / 800	12 / 1200	30	--	--	--					--	--	
				2	14005	BB, ●	89	10 / 1000	12 / 1200	30										
2				15007	BB, ●	97	17 / 2550	17 / 2550	30											
2.5			15010	BB, ●	97	20 / 2700	20 / 2700	30												
15 - 19			2	13187	AA, ●	63	8.0 / 800	12 / 1200	30											
			2	14010	AA, ●	67	10 / 1000	12 / 1200	30											
11 - 19			2	15460	BB, CF	97	17 / 2550	17 / 2550	45											
			2.5	15860	BB, CF	99	20 / 2700	20 / 2700	45											
11 - 14			2	13061	BB, ●	56	8.0 / 800	12 / 1200	30											
			2	14061	BB, ●	67	10 / 1000	12 / 1200	30											
01 - 10		2	13208	D, ●	71	8.0 / 800	12 / 1200	40												
		2	13210	D, ●	63	6.0 / 600	10 / 1000	30												
		2	13211	BB, M, ●	63	6.0 / 600	10 / 1000	30												
2		14211	AA, D	85	10 / 1000	12 / 1200	40													
2.5		15703	BB, CF, ●	89	18 / 2700	18 / 2700	30													
01 - 06	2	14008	AA, ●	69	10 / 1000	12 / 1200	30													
11 - 12	8' BED, BOX DELETE	2	15363	BB, CF, ●	79	16 / 2400	17 / 2400	30												
01 - 10	8' BED, FACTORY REPL. HITCH	2	15312	BB, CF, K, ●	79	16 / 2400	17 / 2400	30												
01 - 10	8' BED, WITH TOMMY GATE LIFT	2	13213	A, TG, ●	71	8.0 / 800	12 / 1200	30												
01 - 10	8' BED, WITH 10" STEP BUMPER	2	15313	BB, CF, ●	85	16 / 2400	17 / 2400	30												
(CONTINUED ON THE NEXT PAGE)	6' BED, EXCL. FACTORY RECEIVER, TOMMY GATE LIFT OR CAB & CHASSIS	07 - 07	2	13208	D, ●	71	8.0 / 800	12 / 1200	40	--	--	--					--	--		
			2	13210	D, ●	63	6.0 / 600	10 / 1000	30											
			2	13211	BB, M, ●	63	6.0 / 600	10 / 1000	30											
			2	13108	AA, ●	45	6.0 / 600	10 / 1000	30											
			2	14108	AA, ●	71	10 / 1000	12 / 1200	30											
			2	14211	AA, D	85	10 / 1000	12 / 1200	40											
			2.5	15703	BB, CF, ●	89	18 / 2700	18 / 2700	30											
	07 - 07	6' BED, FACTORY REPL. HITCH	2	15302	AA, CF, K, ●	79	16 / 2400	17 / 2400	30											

CUSTOM WIRING APPLICATION GUIDE FOOTNOTE KEY						For the most up-to-date application information, please visit curtmfg.com					
T1 Multiple parts available. Visit curtmfg.com	T5 Adds 4-flat to factory equipped 7-way	T9 Without factory tow package	T13 Excluding right hand drive	T17 Single rear wheels	T21 Excluding LTZ						
T2 Replaces factory connector with 4-flat	T6 Without LED taillights	T10 Hybrid only	T14 All wheel drive (AWD) models only	T18 SE models only	T22 Excluding plug-in models						
T3 Replaces factory connector with 6-way	T7 With LED taillights	T11 Excluding hybrid	T15 Excluding Grand Touring	T19 Excluding SE models	See page 33 for T23 - T63 footnote key comments						
T4 Replaces factory connector with 7-way	T8 With factory tow package	T12 Excluding EX and Limited	T16 WRX only	T20 Limited 2.0L and EX 2.0L models only	See page 33 for 'Electrical System Notes'						



TRAILER HITCHES

For 1.25" ordering options, see page 32

CUSTOM WIRING

No splicing required

CWH - For vehicles without OE tow package

ADD - Adds to OE tow package

REPL - Replacement for OE tow package

Splice-in Converters

Make / Model	Style / Notes	Years	Rec. Size	Part#	Foot Note	PC	GTW / TW	WD / WDTW	INS	CUSTOM WIRING						Part#	Sys. Note		
										Years	Part#	Prod Type	Plug	FN	PC			INS	
GMC (CONTINUED)																			
SIERRA 2500 HD CLASSIC (CONTINUED FROM THE PREVIOUS PAGE)	8' BED, EXCL. FACTORY RECEIVER, TOMMY GATE LIFT OR CAB & CHASSIS	07 - 07	2	13208	D, ●	71	8.0 / 800	12 / 1200	40	--	--	--					--	--	
			2	13210	D, ●	63	6.0 / 600	10 / 1000	30										
			2	13211	BB, M, ●	63	6.0 / 600	10 / 1000	30										
			2	14008	AA, ●	69	10 / 1000	12 / 1200	30										
	8' BED, FACTORY REPL. HITCH	07 - 07	2	15312	BB, CF, K, ●	79	16 / 2400	17 / 2400	30										
8' BED, WITH TOMMY GATE LIFT	07 - 07	2	13213	A, TG, ●	71	8.0 / 800	12 / 1200	30											
8' BED, WITH 10" STEP BUMPER	07 - 07	2	15313	BB, CF, ●	85	16 / 2400	17 / 2400	30											
SIERRA 3500	8' BED, EXCL. FACTORY RECEIVER, TOMMY GATE LIFT, 10" DROP BUMPER AND CAB & CHASSIS	01 - 06	2	13208	D, ●	71	8.0 / 800	12 / 1200	40	--	--	--					--	--	
			2	13210	D, ●	63	6.0 / 600	10 / 1000	30										
			2	13211	BB, M, ●	63	6.0 / 600	10 / 1000	30										
			2	14211	AA, D	85	10 / 1000	12 / 1200	40										
			2.5	15703	BB, CF, ●	89	18 / 2700	18 / 2700	30										
			2	14008	AA, ●	69	10 / 1000	12 / 1200	30										
	8' BED, FACTORY REPL. HITCH	01 - 06	2	15312	BB, CF, K, ●	79	16 / 2400	17 / 2400	30										
	8' BED, WITH TOMMY GATE LIFT	01 - 06	2	13213	A, TG, ●	71	8.0 / 800	12 / 1200	30										
	8' BED, WITH 10" DROP BUMPER	01 - 06	2	15313	BB, CF, ●	85	16 / 2400	17 / 2400	30										
SIERRA 3500 CLASSIC	EXCL. FACTORY RECEIVER, TOMMY GATE LIFT, 10" DROP BUMPER AND CAB & CHASSIS	07 - 07	2	13208	D, ●	71	8.0 / 800	12 / 1200	40	--	--	--					--	--	
			2	13210	D, ●	63	6.0 / 600	10 / 1000	30										
			2	13211	BB, M, ●	63	6.0 / 600	10 / 1000	30										
			2	14211	AA, D	85	10 / 1000	12 / 1200	40										
			2.5	15703	BB, CF, ●	89	18 / 2700	18 / 2700	30										
			2	14008	AA, ●	69	10 / 1000	12 / 1200	30										
FACTORY REPL. HITCH	07 - 07	2	15312	BB, CF, K, ●	79	16 / 2400	17 / 2400	30											
WITH TOMMY GATE LIFT	07 - 07	2	13213	A, TG, ●	71	8.0 / 800	12 / 1200	30											
WITH 10" DROP BUMPER	07 - 07	2	15313	BB, CF, ●	85	16 / 2400	17 / 2400	30											
CAB & CHASSIS	07 - 07	2	13028	AA	45	6.0 / 600	10 / 1000	60	--	--	--					--	--		
		2	14082	AA	75	10 / 1000	12 / 1200	60											
		2	15400	BB, CF	83	17 / 2550	17 / 2550	30											
		2.5	15800	BB, CF	88	20 / 2700	20 / 2700	30											

TRAILER HITCH APPLICATION GUIDE FOOTNOTE KEY								For the most up-to-date application information, please visit curtmfg.com							
A Allow additional installation time	CC Roll pan mods required	F Will not fit vehicles with ground effects	HE Hole enlargement required	L Fixed draw bar	Q Temporary bumper removal	TG Compatible with Tommy Gate lifts	VT Vertical receiver tube	AA Main body concealed	CF Carbide black finish	FR Temporary bumper fascia removal	I Will not fit with full size spare	M Round tube main body	R Boxed due to bolt-on arms	U May require battery removal	W Only with boxed rear bumper
B Relocate or modify exhaust	D Minor fascia trim required	G Add'l install w/ load level air compressors	J No spare tire relocation	N Continued while supplies last	S May interfere hands free liftgate sensor	V Under-car trim (not fascia) req'd	● No drilling required	BB Main body exposed	E Noticeable fascia trim required	H Will not fit vehicles with twin tailpipes	K OEM-style hitch	P Not with roll pan bumper	T Modifications required (minor)	X 158" WB models require brace removal, 118" WB models require spare tire reloc.	



TRAILER HITCHES

For 1.25" ordering options, see page 32

CUSTOM WIRING

No splicing required

CWH - For vehicles without OE tow package

ADD - Adds to OE tow package

REPL - Replacement for OE tow package

Splice-in Converters

Make / Model	Style / Notes	Years	TRAILER HITCHES							CUSTOM WIRING							Part#	Sys. Note
			Rec. Size	Part#	Foot Note	PC	GTW / TW	WD / WDTW	INS	Years	Part#	Prod Type	Plug	FN	PC	INS		
GMC (CONTINUED)																		
SIERRA 3500 HD	6' BED, EXCL. FACTORY RECEIVER, TOMMY GATE LIFT OR CAB & CHASSIS	20 - 25	2	13447	BB, ●	88	8.0 / 800	12 / 1200	30	--	--	--					--	--
			2	14005	BB, ●	89	10 / 1000	12 / 1200	30									
			2	15007	BB, ●	97	17 / 2550	17 / 2550	30									
			2.5	15010	BB, ●	97	20 / 2700	20 / 2700	30									
		15 - 19	2	13178	AA, ●	56	8.0 / 800	12 / 1200	30									
			2	14009	AA, ●	63	10 / 1000	12 / 1200	30									
		11 - 19	2	15460	BB, CF	97	17 / 2550	17 / 2550	45									
			2.5	15860	BB, CF	99	20 / 2700	20 / 2700	45									
		11 - 14	2	13062	BB, ●	55	8.0 / 800	12 / 1200	30									
			2	14062	BB, ●	65	10 / 1000	12 / 1200	30									
	8' BED, EXCL. FACTORY RECEIVER, TOMMY GATE LIFT OR CAB & CHASSIS	20 - 25	2	13447	BB, ●	88	8.0 / 800	12 / 1200	30									
			2	14005	BB, ●	89	10 / 1000	12 / 1200	30									
			2	15007	BB, ●	97	17 / 2550	17 / 2550	30									
			2.5	15010	BB, ●	97	20 / 2700	20 / 2700	30									
		15 - 19	2	13187	AA, ●	63	8.0 / 800	12 / 1200	30									
			2	14010	AA, ●	67	10 / 1000	12 / 1200	30									
		11 - 19	2	15460	BB, CF	97	17 / 2550	17 / 2550	45									
			2.5	15860	BB, CF	99	20 / 2700	20 / 2700	45									
		11 - 14	2	13061	BB, ●	56	8.0 / 800	12 / 1200	30									
			2	14061	BB, ●	67	10 / 1000	12 / 1200	30									
07 - 10	2	13208	D, ●	71	8.0 / 800	12 / 1200	40											
	2	13210	D, ●	63	6.0 / 600	10 / 1000	30											
8' BED, BOX DELETE	11 - 12	2	15363	BB, CF, ●	79	16 / 2400	17 / 2400	30										
		2	15312	BB, CF, K, ●	79	16 / 2400	17 / 2400	30										
8' BED, FACTORY REPL. HITCH	07 - 10	2	15312	BB, CF, K, ●	79	16 / 2400	17 / 2400	30										
		2	13213	A, TG, ●	71	8.0 / 800	12 / 1200	30										
8' BED, WITH TOMMY GATE LIFT	07 - 10	2	15313	BB, CF, ●	85	16 / 2400	17 / 2400	30										
		2	15313	BB, CF, ●	85	16 / 2400	17 / 2400	30										
8' BED, WITH 10" STEP BUMPER	07 - 10	2	15313	BB, CF, ●	85	16 / 2400	17 / 2400	30										
		2	15313	BB, CF, ●	85	16 / 2400	17 / 2400	30										
CAB & CHASSIS	07 - 25	2	15400	BB, CF	83	17 / 2550	17 / 2550	30										
		2.5	15800	BB, CF	88	20 / 2700	20 / 2700	30										
SONOMA	--	91 - 04	1.25	12011	●	145	3.5 / 350	--	45	98 - 04	55359	CWH	4-FLAT	E7	5	--	1	
			2	13132	AA, M, P, ●	45	4.0 / 400	6.0 / 600	45	91 - 97	55312	CWH	4-FLAT	E5	5	--	1	
			2	13021	AA, P, Q, ●	45	4.0 / 400	6.0 / 600	45									
	WITH ROLL PAN BUMPER	91 - 04	2	13920	A, D	56	3.5 / 350	5.0 / 500	60									
TERRAIN	EXCL. DIESEL	18 - 24	1.25	12201	AA, HE, ●	129	3.5 / 525	--	30	18 - 24	56429	CWH	4-FLAT	E12	20	--	--	
			2	13439	AA, HE, ●	25	4.5 / 675	4.5 / 675	30	18 - 18	56375	REPL	4-FLAT	E6	20	--	1	
	--	10 - 17	1.25	12291	●	145	3.5 / 350	6.0 / 600	30	10 - 17	56094	CWH	4-FLAT	E8	20	--	1	
			2	13591	M, ●	14	3.5 / 350	4.0 / 400	30		56210	REPL	4-FLAT	E2	20	--	1	
YUKON	--	03 - 06	2	13422	BB, K, M, ●	45	6.0 / 600	10 / 1000	30	92 - 00	55319	CWH	4-FLAT	E5	5	--	1	
			2	15324	BB, CF, ●	71	16 / 2400	17 / 2400	30									
NEW BODY STYLE, 4.8L OR 5.3L	00 - 02	2	13402	●	43	6.0 / 600	10 / 1000	30										
		2	14080	BB, ●	65	10 / 1000	12 / 1200	30										
		2	13029	BB, HE, ●	39	6.0 / 600	10 / 1000	30										
		2	13121	M, ●	46	5.0 / 500	6.0 / 600	30										
OLD BODY STYLE, 5.7L OR 6.5L	92 - 00	2	13121	M, ●	46	5.0 / 500	6.0 / 600	30										
		2	14029	BB, HE, ●	63	10 / 1000	12 / 1200	30										

CUSTOM WIRING APPLICATION GUIDE FOOTNOTE KEY						For the most up-to-date application information, please visit curtmfg.com					
T1 Multiple parts available. Visit curtmfg.com	T5 Adds 4-flat to factory equipped 7-way	T9 Without factory tow package	T13 Excluding right hand drive	T17 Single rear wheels	T21 Excluding LTZ						
T2 Replaces factory connector with 4-flat	T6 Without LED taillights	T10 Hybrid only	T14 All wheel drive (AWD) models only	T18 SE models only	T22 Excluding plug-in models						
T3 Replaces factory connector with 6-way	T7 With LED taillights	T11 Excluding hybrid	T15 Excluding Grand Touring	T19 Excluding SE models	See page 33 for T23 - T63 footnote key comments						
T4 Replaces factory connector with 7-way	T8 With factory tow package	T12 Excluding EX and Limited	T16 WRX only	T20 Limited 2.0L and EX 2.0L models only	See page 33 for 'Electrical System Notes'						



TRAILER HITCHES

For 1.25" ordering options, see page 32

CUSTOM WIRING

No splicing required

CWH - For vehicles without OE tow package

ADD - Adds to OE tow package

REPL - Replacement for OE tow package

Splice-in Converters

Make / Model	Style / Notes	Years	TRAILER HITCHES							CUSTOM WIRING							Part#	Sys. Note		
			Rec. Size	Part#	Foot Note	PC	GTW / TW	WD / WDTW	INS	Years	Part#	Prod Type	Plug	FN	PC	INS				
HONDA																				
ACCORD	COUPE	13 - 17	1.25	11681	BB, V, ●	125	2.0 / 200	--	30	16 - 17	56301	CWH	4-FLAT	N	E20	45	56496	5		
		08 - 12	1.25	11085	BB, HE, M, V, ●	133	2.0 / 200	--	45	13 - 15	56011	CWH	4-FLAT	T6	E13	20	56496	4		
		08 - 10	1.25	11496	M, V	125	2.0 / 200	--	45	13 - 15	56173	CWH	4-FLAT	T7	E18	45	56496	5		
		FRAME MOUNT	03 - 07	1.25	11327	BB	145	2.0 / 200	--	50	11 - 12	56011	CWH	4-FLAT		E13	20	56496	4	
		TRUNK PAN MOUNT	98 - 07	1.25	11290	AA	137	2.0 / 200	--	30	94 - 02	55336	CWH	4-FLAT		E8	10	56496	4	
		SEDAN	23 - 24	1.25	11665	AA, D, FR, Q, V	141	2.0 / 200	--	90	22 - 24	--						56236	5	
		SEDAN, EXCL. HYBRID	18 - 22	1.25	11525	BB, M	137	2.0 / 200	--	60	18 - 22	56402	CWH	4-FLAT		E27	45	56496	5	
		SEDAN	13 - 17	1.25	11681	BB, V, ●	125	2.0 / 200	--	30	17 - 17	56173	CWH	4-FLAT	T7	E18	45	56496	5	
			08 - 12	1.25	11085	BB, HE, M, V, ●	133	2.0 / 200	--	45	16 - 17	56299	CWH	4-FLAT	T37	E14	45	56496	5	
			08 - 10	1.25	11496	M, V	125	2.0 / 200	--	45	13 - 15	56011	CWH	4-FLAT	T6	E13	20	56496	4	
		FRAME MOUNT	03 - 07	1.25	11327	BB	145	2.0 / 200	--	50	13 - 15	56173	CWH	4-FLAT	T7	E18	45	56496	5	
	TRUNK PAN MOUNT	98 - 07	1.25	11290	AA	137	2.0 / 200	--	30	03 - 12	55502	CWH	4-FLAT		E12	10	56496	4		
										94 - 02	55336	CWH	4-FLAT		E8	10	56496	4		
ACCORD CROSSTOUR	--	10 - 11	1.25	11002	BB, M, V, ●	137	2.0 / 200	--	30	10 - 11	56008	CWH	4-FLAT		E12	30	56496	5		
CIVIC	COUPE, EXCL. CENTER EXHAUST	16 - 23	1.25	11591	AA, D, FR, Q, V, ●	133	2.0 / 200	--	60	16 - 19	56324	CWH	4-FLAT		E18	10	56496	5		
		16 - 17	1.25	11463	BB, HE, M, V	137	2.0 / 200	--	30	06 - 15	56051	CWH	4-FLAT	T11	E13	10	56496	4		
		COUPE	06 - 15	1.25	11391	BB, V	137	2.0 / 200	--	30	92 - 05	--	--					56496	4	
	01 - 05		1.25	11204	AA, ●	159	2.0 / 200	--	30											
		COUPE, EXCL. HYBRID	92 - 00	1.25	11207	BB, ●	145	2.0 / 200	--	45										
		HATCHBACK, EXCL. CENTER EXHAUST	16 - 25	1.25	11591	AA, D, FR, Q, V, ●	133	2.0 / 200	--	60	22 - 25	56508	CWH	4-FLAT		E26	45	56496	5	
			17 - 18	1.25	11463	BB, HE, M, V	137	2.0 / 200	--	30	17 - 21	--	--					56236	10	
		SEDAN, EXCL. CENTER EXHAUST	16 - 25	1.25	11591	AA, D, FR, Q, V, ●	133	2.0 / 200	--	60	22 - 25	56508	CWH	4-FLAT		E26	45	56496	5	
			16 - 18	1.25	11604	BB, HE, M	137	2.0 / 200	--	30	16 - 21	56396	CWH	4-FLAT		E26	45	56496	5	
		SEDAN	06 - 15	1.25	11391	BB, V	137	2.0 / 200	--	30	06 - 15	56011	CWH	4-FLAT	T11	E13	20	56496	4	
	01 - 05		1.25	11204	AA, ●	159	2.0 / 200	--	30	01 - 05	56341	CWH	4-FLAT		E18	45	56496	5		
	92 - 00		1.25	11207	BB, ●	145	2.0 / 200	--	45	88 - 00	--	--					56496	4		
	WAGON, EXCL. 4WD	84 - 87	FLAT	11574	L, N	159	1.0 / 100	--	30	84 - 87	--	--					56496	4		
CR-V	EXCL. HYBRID AND TOURING WITH KICK SENSOR	21 - 25	1.25	12169	AA, D, ●	129	3.5 / 350	--	30	17 - 25	56370	CWH	4-FLAT		E12	45	56496	5		
		--	17 - 25	2	13397	AA, B, D, V, ●	14	3.5 / 525	--	30	12 - 16	56158	CWH	4-FLAT		E15	30	56496	5	
		EXCL. HYBRID WITH KICK SENSOR	17 - 20	1.25	12169	AA, D, ●	129	3.5 / 350	--	30	07 - 11	55106	CWH	4-FLAT		E10	30	56496	4	
			--	12 - 16	1.25	11555	BB, D, HE, ●	115	2.0 / 200	--	30									
CR-Z	--	11 - 16	1.25	11077	BB, HE, M, V, ●	129	1.0 / 100	--	60	11 - 16	--	--					56496	5		
CROSSTOUR	--	12 - 15	1.25	11002	BB, M, V, ●	137	2.0 / 200	--	30	13 - 15	56215	CWH	4-FLAT		E12	30	56496	5		
ELEMENT	EXCL. SC	03 - 11	1.25	11700	●	149	2.0 / 200	--	30	05 - 11	--	--					56496	5		
			2	13574	BB, HE, ●	55	3.5 / 350	--	30	03 - 04	55336	CWH	4-FLAT		E8	10	56496	4		
FIT	--	15 - 20	1.25	11406	BB, M, ●	125	2.0 / 200	--	30	15 - 20	56395	CWH	4-FLAT		E28	45	56236	6		
		09 - 13	1.25	11064	BB	129	2.0 / 200	--	45	07 - 13	56011	CWH	4-FLAT		E13	20	56496	4		
		07 - 08	1.25	11058	AA, ●	117	1.5 / 150	--	30											

TRAILER HITCH APPLICATION GUIDE FOOTNOTE KEY

For the most up-to-date application information, please visit curtmfg.com

A Allow additional installation time	CC Roll pan mods required	F Will not fit vehicles with ground effects	HE Hole enlargement required	L Fixed draw bar	Q Temporary bumper removal	TG Compatible with Tommy Gate lifts	VT Vertical receiver tube
AA Main body concealed	CF Carbide black finish	FR Temporary bumper fascia removal	I Will not fit with full size spare	M Round tube main body	R Boxed due to bolt-on arms	U May require battery removal	W Only with boxed rear bumper
B Relocate or modify exhaust	D Minor fascia trim required	G Add'l install w/ load level air compressors	J No spare tire relocation	N Continued while supplies last	S May interfere hands free liftgate sensor	V Under-car trim (not fascia) req'd	● No drilling required
BB Main body exposed	E Noticeable fascia trim required	H Will not fit vehicles with twin tailpipes	K OEM-style hitch	P Not with roll pan bumper	T Modifications required (minor)	X 158" WB models require brace removal, 118" WB models require spare tire reloc.	



TRAILER HITCHES

For 1.25" ordering options, see page 32

CUSTOM WIRING

No splicing required

CWH - For vehicles without OE tow package

ADD - Adds to OE tow package

REPL - Replacement for OE tow package

Splice-in Converters

Make / Model	Style / Notes	Years	TRAILER HITCHES							CUSTOM WIRING								
			Rec. Size	Part#	Foot Note	PC	GTW / TW	WD / WDTW	INS	Years	Part#	Prod Type	Plug	FN	PC	INS	Part#	Sys. Note
HONDA (CONTINUED)																		
HR-V	--	23 - 25	1.25	11640	AA, D, ●	129	2.0 / 200	--	60	23 - 25	56483	CWH	4-FLAT	E25	45	56236	10	
		16 - 22	1.25	11416	BB, V, ●	135	2.0 / 200	--	30	16 - 22	56284	CWH	4-FLAT	E17	45	56496	5	
ODYSSEY	--	18 - 25	1.25	12175	BB, D, M, ●	147	3.5 / 350	--	30	18 - 25	56382	CWH	4-FLAT	E14	20	56496	5	
			2	13523	AA, D, FR, Q, V, ●	35	3.5 / 525	--	90	11 - 17	56378	CWH	4-FLAT	E16	20	56496	5	
		99 - 17	2	13370	BB, M, ●	35	3.5 / 525	5.0 / 525	30	05 - 10	56161	CWH	4-FLAT	E13	15	56236	6	
			1.25	12031	BB, M, ●	145	3.5 / 350	--	30	95 - 04	55336	CWH	4-FLAT	E8	10	56496	4	
			2	13068	BB, D, M, ●	25	3.5 / 350	5.0 / 500	30									
95 - 98	1.25	11211	BB, N	159	2.0 / 200	--	40											
PASSPORT	--	19 - 25	2	13421	AA, ●	51	5.0 / 750	6.0 / 750	30	19 - 25	56291	CWH	4-FLAT	E13	20	56496	5	
		98 - 02	2	13222	M, ●	35	4.0 / 400	6.0 / 600	30		56421	CWH	7-WAY	T4	E27	45	56496	5
		98 - 02	2	13235	N, ●	37	4.0 / 400	6.0 / 600	30	98 - 02	55360	CWH	4-FLAT	E21	15	56496	4	
PILOT	--	23 - 25	2	13472	AA, S, ●	53	6.0 / 900	8.0 / 900	30	23 - 25	56519	CWH	4-FLAT	E16	45	56496	5	
		16 - 22	2	13146	AA, ●	49	6.0 / 900	8.0 / 900	30		56518	CWH	7-WAY	E25	45	56496	5	
		03 - 08	2	13328	●	45	3.5 / 350	5.0 / 500	30	16 - 22	56291	CWH	4-FLAT	E13	20	56496	5	
											56421	CWH	7-WAY	T4	E27	45	56496	5
											56170	CWH	4-FLAT	E25	20	56496	5	
		09 - 11	56366	CWH	7-WAY	T4	E27	20	56496	5								
			56365	CWH	4-FLAT	T2	E20	20	56496	5								
03 - 08	55336	CWH	4-FLAT	E8	10	56496	4											
PROLOGUE	--	24 - 24	2	13617	BB, HE, V, ●	33	3.5 / 350	--	60	24 - 24	56427	CWH	4-FLAT	E5	5	--	10	
RIDGELINE	--	06 - 14	2	13385	AA, ●	56	5.0 / 500	6.0 / 600	30	17 - 25	56365	CWH	4-FLAT	E20	20	56496	5	
											56366	CWH	7-WAY	E27	20	56496	5	
										06 - 14	55585	CWH	4-FLAT	E19	10	56496	4	
S2000	--	04 - 09	1.25	11198	AA, HE, N	159	2.0 / 200	--	30	04 - 09	--	--				56496	5	
HUMMER																		
H3	--	06 - 10	2	13270	●	59	5.0 / 500	5.5 / 550	30	--	--	--				--	--	
HYUNDAI																		
ACCENT	HATCHBACK	12 - 17	1.25	11250	BB, M	145	2.0 / 200	--	30	13 - 17	56254	CWH	4-FLAT	E15	20	56496	4	
		95 - 12	--	--												56496	4	
	SEDAN	18 - 20	1.25	11548	AA, M, V	155	2.0 / 200	--	35	18 - 20	--	--				56496	5	
		12 - 17	1.25	11250	BB, M	145	2.0 / 200	--	30	12 - 17	56149	CWH	4-FLAT	E15	20	56496	4	
ELANTRA	HATCHBACK	06 - 11	1.25	11094	AA, ●	145	2.0 / 200	--	30	95 - 11	--	--				56496	4	
		09 - 12	1.25	11471	BB, M, ●	129	2.0 / 200	--	30	09 - 12	55310	CWH	4-FLAT	E13	20	56496	4	
	SEDAN, EXCL. N, N LINE, OR HYBRID	21 - 24	1.25	11630	BB, M, V	125	2.0 / 200	--	90	21 - 24	56470	CWH	4-FLAT	E26	45	56496	5	
	SEDAN, WITH FACTORY RECOVERY LOOP	17 - 18	1.25	11424	BB, M, V, ●	129	2.0 / 200	--	45	17 - 20	56233	CWH	4-FLAT	T38	E20	45	56496	5
	SEDAN	11 - 16	1.25	11303	BB, HE, M	129	2.0 / 200	--	30	17 - 18	56316	CWH	4-FLAT	T39	E19	45	56496	5
07 - 10		1.25	11467	BB, HE, ●	135	2.0 / 200	--	35	16 - 16	56126	CWH	4-FLAT	T38	E14	20	56496	4	
		16 - 16	56283	CWH	4-FLAT	N, T39	E21	45	56496	4								
11 - 15	56126	CWH	4-FLAT	E14	20	56496	4											
06 - 10	56049	CWH	4-FLAT	E13	10	56496	4											
ELANTRA COUPE	--	13 - 14	1.25	11303	BB, HE, M	129	2.0 / 200	--	30	13 - 15	--	--				56496	5	
ELANTRA GT	BASE, SINGLE EXHAUST ONLY	18 - 20	1.25	11509	BB, M, ●	145	2.0 / 200	--	30	14 - 17	56233	CWH	4-FLAT	E20	45	56496	5	
		13 - 17	1.25	11400	BB	133	2.0 / 200	--	30									
ENTOURAGE	--	07 - 10	2	13345	M, ●	59	3.5 / 350	4.0 / 400	30	07 - 10	56347	CWH	4-FLAT	E20	45	56236	5	
GENESIS	EXCL. 5.0	09 - 16	1.25	12086	M	153	3.5 / 350	--	90	15 - 16	56264	CWH	4-FLAT	E17	45	56496	5	
		15 - 16	1.25	12165	BB, M, V	157	3.5 / 350	--	30	09 - 14	56041	CWH	4-FLAT	E14	20	56496	5	
		12 - 12	1.25	12165	BB, M, V	157	3.5 / 350	--	30									

CUSTOM WIRING APPLICATION GUIDE FOOTNOTE KEY						For the most up-to-date application information, please visit curtmfg.com					
T1 Multiple parts available. Visit curtmfg.com	T5 Adds 4-flat to factory equipped 7-way	T9 Without factory tow package	T13 Excluding right hand drive	T17 Single rear wheels	T21 Excluding LTZ						
T2 Replaces factory connector with 4-flat	T6 Without LED taillights	T10 Hybrid only	T14 All wheel drive (AWD) models only	T18 SE models only	T22 Excluding plug-in models						
T3 Replaces factory connector with 6-way	T7 With LED taillights	T11 Excluding hybrid	T15 Excluding Grand Touring	T19 Excluding SE models	See page 33 for T23 - T63 footnote key comments						
T4 Replaces factory connector with 7-way	T8 With factory tow package	T12 Excluding EX and Limited	T16 WRX only	T20 Limited 2.0L and EX 2.0L models only	See page 33 for 'Electrical System Notes'						



TRAILER HITCHES

For 1.25" ordering options, see page 32

CUSTOM WIRING

No splicing required

CWH - For vehicles without OE tow package

ADD - Adds to OE tow package

REPL - Replacement for OE tow package

Splice-in Converters

Make / Model	Style / Notes	Years	TRAILER HITCHES							CUSTOM WIRING							Part#	Sys. Note
			Rec. Size	Part#	Foot Note	PC	GTW / TW	WD / WDTW	INS	Years	Part#	Prod Type	Plug	FN	PC	INS		
HYUNDAI (CONTINUED)																		
GENESIS COUPE	--	10 - 16	1.25	11086	BB, HE, N, M, ●	159	2.0 / 200	--	30	10 - 16	--	--				56496	5	
IONIQ	EXCL. ELECTRIC OR PLUG-IN	17 - 22	1.25	11486	AA, V, ●	137	2.0 / 200	--	30	17 - 22	56233	CWH	4-FLAT	T40	E20	45	56496	5
											56381	CWH	4-FLAT	T41	E19	45	56496	5
IONIQ5	--	22 - 24	2	13520	AA, M, V, ●	53	2.5 / 250	--	60	22 - 24	56484	CWH	4-FLAT		E25	45	--	10
IONIQ5 N	--	25 - 25	2	13520	AA, M, V, ●	53	2.5 / 250	--	60	25 - 25	--	--					--	10
KONA	EXCL. N LINE OR ELECTRIC N LINE	24 - 24	2	13606	AA, M, ●	45	2.0 / 200	--	30	22 - 23	56504	CWH	4-FLAT		E24	60	56496	5
		24 - 24	2	13608	AA, M, V, ●	45	2.0 / 200	--	30	18 - 21	56409	CWH	4-FLAT		E26	45	56496	5
		18 - 23	2	13610	AA, V, ●	48	2.0 / 200	--	70									
	EXCL. ELECTRIC	22 - 23	1.25	11638	AA, N, ●	157	2.0 / 200	--	65									
		18 - 22	1.25	11529	AA, N, ●	157	2.0 / 200	--	30									
KONA ELECTRIC	--	24 - 24	2	13608	AA, M, V, ●	45	2.0 / 200	--	30	24 - 24	--	--					--	10
		19 - 23	2	13610	AA, V, ●	48	2.0 / 200	--	70	22 - 23	56504	CWH	4-FLAT		E24	60	56496	5
										19 - 21	56409	CWH	4-FLAT		E26	45	56496	5
KONA N	--	22 - 23	2	13610	AA, V, ●	48	2.0 / 200	--	70	22 - 23	56504	CWH	4-FLAT		E24	60	56496	5
			1.25	11638	AA, N, ●	157	2.0 / 200	--	65									
PALISADE	--	20 - 25	2	13427	AA, M, ●	55	5.0 / 750	6.0 / 750	45	23 - 24	56491	CWH	4-FLAT		E25	45	56236	10
										20 - 22	56420	CWH	4-FLAT		E16	5	56236	10
											56466	CWH	7-WAY		E23	45	56236	10
SANTA CRUZ	--	22 - 24	2	13486	AA, ●	56	5.0 / 750	--	45	22 - 24	56420	CWH	4-FLAT		E16	5	56236	10
											56466	CWH	7-WAY		E23		56236	10
SANTA FE	--	21 - 24	2	13609	AA, ●	35	4.0 / 600	--	30	19 - 23	56420	CWH	4-FLAT		E16	5	56496	5
		19 - 20	2	13195	BB, M, ●	49	5.0 / 750	--	45	13 - 18	56184	CWH	4-FLAT	T9	E23	45	56496	5
		13 - 18	2	13153	AA, K, ●	45	6.0 / 900	8.0 / 900	30		56332	REPL	4-FLAT	T2	E17	20	56236	5
		10 - 12	2	13073	BB, D, M, V	33	3.5 / 350	--	30	07 - 12	56346	REPL	4-FLAT	T2	E13	20	56496	5
		07 - 09	2	13538	●	59	3.5 / 350	--	30		56078	CWH	4-FLAT		E13	20	56496	5
		01 - 06	2	13505	M, ●	43	4.0 / 400	--	45	01 - 06	55310	CWH	4-FLAT		E13	20	56496	4
SANTA FE SPORT	--	13 - 18	1.25	12113	BB, M, N, ●	137	3.5 / 350	--	30	13 - 18	56184	CWH	4-FLAT		E23	45	56496	5
			2	13152	BB, M, ●	35	6.0 / 900	8.0 / 900	30									
SANTA FE XL	--	19 - 19	2	13153	AA, K, ●	45	6.0 / 900	8.0 / 900	30	19 - 19	56332	REPL	4-FLAT	T2	E17	20	56236	5
SONATA	EXCL. N LINE	20 - 24	1.25	11673	BB, ●	149	2.0 / 200	--	30	24 - 24	56529	CWH	4-FLAT		E24	60	56236	2
	EXCL. HYBRID	20 - 23	1.25	11619	BB, N, ●	145	2.0 / 200	--	30	20 - 23	56461	CWH	4-FLAT		E24	45	56496	5
		15 - 19	1.25	11402	BB, M	137	2.0 / 200	--	30	18 - 19	56390	CWH	4-FLAT		E20	30	56496	5
		11 - 14	1.25	11025	BB, HE, M, V, ●	133	2.0 / 200	--	30	15 - 17	56247	CWH	4-FLAT	T11	E15	20	56496	4
		06 - 10	1.25	11325	BB, D, V, ●	137	2.0 / 200	--	35	11 - 15	56241	CWH	4-FLAT	N, T10	E18	30	56496	5
									06 - 14	56049	CWH	4-FLAT	T11	E13	10	56496	4	
TUCSON	--	22 - 25	2	13485	AA, ●	49	3.5 / 525	--	30	22 - 24	56420	CWH	4-FLAT		E16	5	56236	10
	EXCL. NIGHT	16 - 21	1.25	12241	AA, ●	135	3.5 / 350	--	30		56466	CWH	7-WAY		E23		56236	10
			2	13240	AA, M, ●	35	3.5 / 525	--	30	19 - 21	56442	CWH	4-FLAT		E25	45	56236	5
		10 - 15	1.25	12030	AA, ●	129	3.5 / 350	--	30	10 - 18	56348	CWH	4-FLAT		E21	45	56496	5
			2	13066	BB, ●	25	3.5 / 350	--	30	05 - 09	55528	CWH	4-FLAT		E19	20	56496	4
			2	13120	AA, ●	37	3.5 / 525	5.2 / 525	30									
		05 - 09	1.25	12126	AA, ●	145	3.5 / 300	--	30									
		2	13526	AA, ●	37	3.5 / 350	--	30										
VELOSTER	EXCL. VELOSTER N	19 - 21	1.25	11550	BB, M, ●	157	2.0 / 200	--	30	19 - 21	56442	CWH	4-FLAT		E25	45	56236	5
	--	12 - 17	1.25	11254	BB, HE, M, ●	163	1.0 / 100	--	30	12 - 17	56153	CWH	4-FLAT		E26	45	56496	5
VENUE	--	20 - 24	1.25	11609	AA, ●	153	2.0 / 200	--	30	20 - 24	56451	CWH	4-FLAT		E21	60	56236	5
VERACRUZ	--	07 - 12	2	13545	●	71	3.5 / 350	--	60	07 - 12	56332	REPL	4-FLAT	T2	E17	20	56236	5

TRAILER HITCH APPLICATION GUIDE FOOTNOTE KEY

For the most up-to-date application information, please visit curtmfg.com

A Allow additional installation time	CC Roll pan mods required	F Will not fit vehicles with ground effects	HE Hole enlargement required	L Fixed draw bar	Q Temporary bumper removal	TG Compatible with Tommy Gate lifts	VT Vertical receiver tube
AA Main body concealed	CF Carbide black finish	FR Temporary bumper fascia removal	I Will not fit with full size spare	M Round tube main body	R Boxed due to bolt-on arms	U May require battery removal	W Only with boxed rear bumper
B Relocate or modify exhaust	D Minor fascia trim required	G Add'l install w/ load level air compressors	J No spare tire relocation	N Continued while supplies last	S May interfere hands free liftgate sensor	V Under-car trim (not fascia) req'd	● No drilling required
BB Main body exposed	E Noticeable fascia trim required	H Will not fit vehicles with twin tailpipes	K OEM-style hitch	P Not with roll pan bumper	T Modifications required (minor)	X 158" WB models require brace removal, 118" WB models require spare tire reloc.	



TRAILER HITCHES

For 1.25" ordering options, see page 32

CUSTOM WIRING

No splicing required

CWH - For vehicles without OE tow package

ADD - Adds to OE tow package

REPL - Replacement for OE tow package

Splice-in Converters

Make / Model	Style / Notes	Years	TRAILER HITCHES							CUSTOM WIRING							Part#	Sys. Note
			Rec. Size	Part#	Foot Note	PC	GTW / TW	WD / WDTW	INS	Years	Part#	Prod Type	Plug	FN	PC	INS		
INFINITI																		
EX35	--	08 - 12	1.25	11510	AA, ●	153	1.5 / 150	--	60	08 - 09	--	--				56496	5	
EX37	--	13 - 13	1.25	11510	AA, ●	153	1.5 / 150	--	60	13 - 13	--	--				--	10	
FX35	--	09 - 12	2	13554	M, V, ●	53	4.0 / 400	--	40	09 - 12	56074	CWH	4-FLAT	E18	30	56496	5	
		03 - 08	2	13558	BB	65	3.5 / 350	--	45	03 - 08	--	--				--	10	
FX45	--	03 - 08	2	13558	BB	65	3.5 / 350	--	45	03 - 08	--	--				--	10	
FX37	--	09 - 14	2	13554	M, V, ●	53	4.0 / 400	--	40	13 - 13	56074	CWH	4-FLAT	E18	30	56496	5	
FX50	--	09 - 13	2	13554	M, V, ●	53	4.0 / 400	--	40	09 - 13	56074	CWH	4-FLAT	E18	30	56496	5	
G25	--	11 - 12	1.25	11499	AA, D, ●	129	2.0 / 200	--	60	11 - 12	56033	CWH	4-FLAT	E20	30	56496	5	
G35	SEDAN	07 - 08	1.25	11499	AA, D, ●	129	2.0 / 200	--	60	07 - 08	56033	CWH	4-FLAT	E20	30	56496	5	
		03 - 06	1.25	11482	D, N	163	2.0 / 200	--	45	03 - 06	--	--				56496	5	
G37	COUPE	08 - 13	1.25	11493	N, Q	175	1.5 / 150	--	90	08 - 13	--	--				--	10	
		SEDAN	09 - 13	1.25	11499	AA, D, ●	129	2.0 / 200	--	60	09 - 13	56033	CWH	4-FLAT	E20	30	56496	5
J30	--	93 - 97	1.25	11727	N, ●	191	2.0 / 200	--	30	93 - 97	--	--				56496	4	
Q45	--	90 - 96	1.25	11801	BB, N	194	2.5 / 200	--	30	90 - 96	--	--				56496	5	
Q50	EXCL. SPORT	14 - 24	1.25	11407	AA	141	2.0 / 200	--	30	14 - 24	56248	CWH	4-FLAT	E21	45	56496	5	
Q60	COUPE	14 - 14	1.25	11493	N, Q	175	1.5 / 150	--	90	14 - 15	56033	CWH	4-FLAT	E20	30	--	--	
QX4	--	97 - 03	2	13088	●	55	5.0 / 500	6.0 / 600	35	97 - 03	55361	CWH	4-FLAT	E14	20	56496	4	
			2	13156	M, ●	59	5.0 / 500	6.0 / 600	30									
QX30	--	17 - 19	2	13197	AA, ●	51	4.0 / 600	--	60	17 - 19	--	--				56496	2	
QX50	--	19 - 24	2	13601	AA, ●	33	4.0 / 400	--	30	19 - 24	--	--				--	10	
		14 - 17	1.25	11510	AA, ●	153	1.5 / 150	--	60	14 - 17	--	--				--	10	
QX56	--	04 - 10	2	13188	M, ●	45	6.0 / 600	10 / 1000	30	--	--	--				--	--	
QX60	--	22 - 25	2	13512	AA, D, ●	61	6.0 / 900	6.0 / 900	45	22 - 24	56520	CWH	4-FLAT	E10	30	--	10	
		14 - 20	2	13126	AA, D, ●	27	4.0 / 600	5.0 / 600	40	14 - 21	56357	CWH	7-WAY	E27	30	--	--	
											56281	CWH	4-FLAT	E26	30	--	10	
QX70	--	14 - 17	2	13554	M, V, ●	53	4.0 / 400	--	40	14 - 17	--	--				--	10	
INTERNATIONAL																		
SCOUT II	--	71 - 80	2	13580	●	67	5.0 / 500	--	30	71 - 80	--	--				--	1	
ISUZU																		
AMIGO	--	98 - 00	2	13235	N, ●	37	4.0 / 400	6.0 / 600	30	98 - 00	55360	CWH	4-FLAT	E21	15	56496	4	
		89 - 94	1.25	12181	N, ●	167	3.5 / 300	--	30	89 - 94	--	--				56496	4	
	EXCL. 2.3L	89 - 94	2	13235	N, ●	37	4.0 / 400	6.0 / 600	30									
AXIOM	WITH UNDER-VEHICLE SPARE	02 - 04	2	13222	M, ●	35	4.0 / 400	6.0 / 600	30	02 - 03	--	--				56496	4	
HOMBRE	--	96 - 00	1.25	12011	●	145	3.5 / 350	--	45	98 - 00	55359	CWH	4-FLAT	E7	5	--	1	
			2	13021	AA, P, Q, ●	45	4.0 / 400	6.0 / 600	45	96 - 97	55312	CWH	4-FLAT	E5	5	--	1	
			2	13132	AA, M, P, ●	45	4.0 / 400	6.0 / 600	45									
I-280	--	06 - 06	2	13252	BB, M, ●	35	4.0 / 400	6.0 / 600	30	06 - 06	55510	CWH	4-FLAT	E12	10	56496	4	
											56510	CWH	5-FLAT	E16	10	56496	4	
I-290	--	07 - 08	2	13252	BB, M, ●	35	4.0 / 400	6.0 / 600	30	07 - 08	55510	CWH	4-FLAT	E12	10	56496	4	
											56510	CWH	5-FLAT	E16	10	56496	4	
I-350	--	06 - 06	2	13252	BB, M, ●	35	4.0 / 400	6.0 / 600	30	06 - 06	55510	CWH	4-FLAT	E12	10	56496	4	
I-370	--	07 - 08	2	13252	BB, M, ●	35	4.0 / 400	6.0 / 600	30	07 - 08	55510	CWH	4-FLAT	E12	10	56496	4	
											56510	CWH	5-FLAT	E16	10	56496	4	
OASIS	--	96 - 99	1.25	11211	BB, N	159	2.0 / 200	--	40	96 - 99	55336	CWH	4-FLAT	E8	10	56496	4	
RODEO	WITH UNDER-VEHICLE SPARE, EXCL. 3.5L	98 - 04	2	13222	M, ●	35	4.0 / 400	6.0 / 600	30	98 - 04	55360	CWH	4-FLAT	E21	15	56496	4	
		98 - 04	2	13235	N, ●	37	4.0 / 400	6.0 / 600	30	92 - 97	--	--				56496	4	
RODEO SPORT	WITH UNDER-VEHICLE SPARE	01 - 03	2	13222	M, ●	35	4.0 / 400	6.0 / 600	30	01 - 03	55360	CWH	4-FLAT	E21	15	56496	4	
		01 - 03	2	13235	N, ●	37	4.0 / 400	6.0 / 600	30									
TROOPER	--	92 - 02	2	13098	●	51	5.0 / 500	6.0 / 600	30	92 - 02	55339	CWH	4-FLAT	E9	10	56496	4	
		88 - 91	1.25	12181	N, ●	167	3.5 / 300	--	30	88 - 91	--	--				56496	4	

CUSTOM WIRING APPLICATION GUIDE FOOTNOTE KEY						For the most up-to-date application information, please visit curtmfg.com					
T1 Multiple parts available. Visit curtmfg.com	T5 Adds 4-flat to factory equipped 7-way	T9 Without factory tow package	T13 Excluding right hand drive	T17 Single rear wheels	T21 Excluding LTZ						
T2 Replaces factory connector with 4-flat	T6 Without LED taillights	T10 Hybrid only	T14 All wheel drive (AWD) models only	T18 SE models only	T22 Excluding plug-in models						
T3 Replaces factory connector with 6-way	T7 With LED taillights	T11 Excluding hybrid	T15 Excluding Grand Touring	T19 Excluding SE models	See page 33 for T23 - T63 footnote key comments						
T4 Replaces factory connector with 7-way	T8 With factory tow package	T12 Excluding EX and Limited	T16 WRX only	T20 Limited 2.0L and EX 2.0L models only	See page 33 for 'Electrical System Notes'						



TRAILER HITCHES

For 1.25" ordering options, see page 32

CUSTOM WIRING

No splicing required

CWH - For vehicles without OE tow package

ADD - Adds to OE tow package

REPL - Replacement for OE tow package

Splice-in Converters

Make / Model	Style / Notes	Years	TRAILER HITCHES							CUSTOM WIRING						Part#	Sys. Note	
			Rec. Size	Part#	Foot Note	PC	GTW / TW	WD / WDTW	INS	Years	Part#	Prod Type	Plug	FN	PC			INS
JAGUAR																		
F-PACE	--	17 - 25	2	13291	AA, FR, V, ●	67	6.0 / 900	--	60	17 - 18	--	--				56496	5	
JEEP																		
CHEROKEE	--	19 - 23	2	13395	AA, V, ●	43	4.5 / 675	5.5 / 750	35	19 - 23	56406	CWH	4-FLAT	E30	45	56236	2	
		14 - 19	2	13171	BB, FR, Q, ●	45	5.0 / 750	6.0 / 750	30	14 - 18	56208	CWH	4-FLAT	E21	45	56496	2	
		14 - 18	2	13172	AA, D, ●	35	5.0 / 750	6.0 / 750	30	97 - 01	55354	CWH	4-FLAT	E12	20	56496	4	
		84 - 01	1.25	12137	N, ●	163	3.5 / 350	--	35									
			2	13084	AA, ●	39	5.0 / 500	6.0 / 600	35									
			2	13160	M, ●	43	5.0 / 500	6.0 / 600	35									
CJ5	--	78 - 83	2	13412	R	103	4.0 / 400	--	45	78 - 96	--	--				--	1	
CJ7	--	78 - 83	2	13412	R	103	4.0 / 400	--	45	78 - 96	--	--				--	1	
COMMANDER	EXCL. ROCKY MOUNTAIN EDITION	06 - 10	2	13414	●	14	5.0 / 500	7.5 / 750	30	06 - 10	55414	CWH	4-FLAT	E20	15	56496	4	
											55381	ADD	4-FLAT	T5	E9	5	--	1
COMPASS	--	18 - 24	1.25	12174	AA, D, HE, ●	149	3.5 / 350	--	45	22 - 23	56472	CWH	4-FLAT	E23	45	56496	2	
			2	13363	AA, D, HE, S, ●	46	4.0 / 600	--	45	18 - 21	56369	CWH	4-FLAT	E25	45	56496	2	
	BUILT IN MEXICO	17 - 17	1.25	12174	AA, D, HE, ●	149	3.5 / 350	--	45	17 - 17	56369	CWH	4-FLAT	T50	E25	45	56496	2
			2	13363	AA, D, HE, ●	46	4.0 / 600	--	45	17 - 17	56344	CWH	4-FLAT	T49	E21	45	56236	2
	BUILT IN USA	17 - 17	1.25	12057	AA, D, ●	129	3.5 / 300	--	30	11 - 16	56344	CWH	4-FLAT	E21	45	56236	2	
			2	13081	AA, D, ●	27	4.0 / 400	--	30	07 - 10	--					56496	5	
	--	11 - 16	1.25	12057	AA, D, ●	129	3.5 / 300	--	30									
			2	13081	AA, D, ●	27	4.0 / 400	--	30									
		07 - 10	1.25	12255	D, N	129	3.5 / 300	--	45									
			2	13548	AA, D, ●	33	4.0 / 400	--	45									
GLADIATOR	--	20 - 24	2	13434	AA, ●	13	5.0 / 500	--	30	20 - 24	56407	CWH	4-FLAT	E28	25	56496	2	
			2	13503	BB, M, ●	51	7.5 / 750	8.0 / 800	30									
GRAND CHEROKEE	EXCL. TRAILHAWK	22 - 24	2	13525	AA, FR, Q, ●	53	7.5 / 750	7.5 / 750	120	22 - 24	56473	CWH	4-FLAT	E22	45	--	10	
			2	13507	AA, FR, N, Q, ●	61	7.5 / 750	7.5 / 750	120	14 - 21	56426	CWH	4-FLAT	E22	45	--	10	
	EXCL. SRT, SRT8 OR TRACKHAWK	12 - 21	2	13182	BB, M, ●	27	6.0 / 600	7.5 / 750	30	07 - 13	56009	CWH	4-FLAT	E9	15	--	1	
	EXCL. SRT, SRT8, TRACKHAWK OR DIESEL	11 - 21	2	13065	AA, ●	25	5.0 / 500	7.5 / 750	30	05 - 06	55451	CWH	4-FLAT	E21	20	56496	4	
	SRT8	07 - 10	1.25	11103	AA, N, ●	133	2.0 / 200	--	30	00 - 10	55381	ADD	4-FLAT	T5	E9	5	--	1
	EXCL. SRT8	05 - 10	2	13251	K, ●	15	5.0 / 500	5.5 / 550	30	99 - 04	55369	CWH	4-FLAT	E12	10	56496	5	
	--	99 - 04	2	13051	BB, M, ●	39	5.0 / 500	6.0 / 600	30	94 - 98	55349	CWH	4-FLAT	E19	25	56496	5	
		93 - 98	2	13048	●	43	5.0 / 500	8.0 / 800	35	95 - 98	55260	REPL	4-FLAT	T2	E14	25	56496	5
GRAND CHEROKEE L	--	21 - 24	2	13525	AA, FR, Q, ●	53	7.5 / 750	7.5 / 750	120	21 - 24	56473	CWH	4-FLAT	E22	45	56236	10	
GRAND CHEROKEE WK	--	22 - 22	2	13182	BB, M, ●	27	6.0 / 600	7.5 / 750	30	22 - 22	56426	CWH	4-FLAT	E22	45	--	10	
			2	13065	AA, ●	25	5.0 / 500	7.5 / 750	30									
LIBERTY	--	08 - 12	1.25	12245	●	145	3.5 / 350	--	30	08 - 12	56334	CWH	4-FLAT	E24	15	56236	5	
			2	13245	AA, M, ●	47	5.0 / 500	7.5 / 750	30	05 - 08	55381	ADD	4-FLAT	T5	E9	5	--	--
		02 - 07	2	13044	●	43	5.0 / 500	--	30	02 - 07	55382	CWH	4-FLAT	E16	10	56496	1	
PATRIOT	--	11 - 17	1.25	12057	AA, D, ●	129	3.5 / 300	--	30	08 - 17	56333	CWH	4-FLAT	E20	30	56236	2	
			2	13081	AA, D, ●	27	4.0 / 400	--	30	07 - 07	--					56496	5	
		07 - 10	1.25	12255	N	129	3.5 / 300	--	45									
			2	13548	AA, D, ●	33	4.0 / 400	--	45									
RENEGADE	--	15 - 23	1.25	12142	BB, M	147	3.5 / 350	--	30	15 - 23	56274	CWH	4-FLAT	E32	45	56236	2	
			2	13269	BB, HE, M, ●	29	3.5 / 525	--	30									
	EXCL. 4WD	15 - 15	1.25	12138	BB, N	135	2.0 / 200	--	30									
WRANGLER	JL, EXCL. DIESEL	18 - 24	2	13392	B, HE, ●	12	3.5 / 350	4.0 / 400	30	18 - 24	56407	CWH	4-FLAT	E28	25	56496	2	
	JL, DIESEL	20 - 24	2	13564	AA, HE, ●	12.5	3.5 / 350	4.0 / 400	35									
	JK	07 - 18	2	13392	B, HE, ●	12	3.5 / 350	4.0 / 400	30	07 - 18	55124	CWH	4-FLAT	T13	E7	10	--	1
	TJ	97 - 06	2	13430	BB, M, ●	29	4.0 / 400	--	30	98 - 06	55363	CWH	4-FLAT	E11	10	--	1	
			2	13408	BB, ●	39	4.0 / 400	--	35	97 - 97	55356	CWH	4-FLAT	E9	10	--	1	
	YJ, EXCL. RENEGADE	87 - 95	2	13657	●	51	3.5 / 350	--	30	91 - 95	55356	CWH	4-FLAT	E9	10	--	1	

TRAILER HITCH APPLICATION GUIDE FOOTNOTE KEY

For the most up-to-date application information, please visit curtmfg.com

A Allow additional installation time	CC Roll pan mods required	F Will not fit vehicles with ground effects	HE Hole enlargement required	L Fixed draw bar	Q Temporary bumper removal	TG Compatible with Tommy Gate lifts	VT Vertical receiver tube
AA Main body concealed	CF Carbide black finish	FR Temporary bumper fascia removal	I Will not fit with full size spare	M Round tube main body	R Boxed due to bolt-on arms	U May require battery removal	W Only with boxed rear bumper
B Relocate or modify exhaust	D Minor fascia trim required	G Add'l install w/ load level air compressors	J No spare tire relocation	N Continued while supplies last	S May interfere hands free liftgate sensor	V Under-car trim (not fascia) req'd	● No drilling required
BB Main body exposed	E Noticeable fascia trim required	H Will not fit vehicles with twin tailpipes	K OEM-style hitch	P Not with roll pan bumper	T Modifications required (minor)	X 158" WB models require brace removal, 118" WB models require spare tire reloc.	



TRAILER HITCHES

For 1.25" ordering options, see page 32

CUSTOM WIRING

No splicing required

CWH - For vehicles without OE tow package

ADD - Adds to OE tow package

REPL - Replacement for OE tow package

Splice-in Converters

Make / Model	Style / Notes	Years	TRAILER HITCHES							CUSTOM WIRING						Part#	Sys. Note	
			Rec. Size	Part#	Foot Note	PC	GTW / TW	WD / WDTW	INS	Years	Part#	Prod Type	Plug	FN	PC			INS
KIA (CONTINUED)																		
SPORTAGE	--	23 - 25	2	13485	AA, ●	49	3.5 / 525	--	30	23 - 24	56474	CWH	4-FLAT	E24	45	56236	6	
		17 - 22	1.25	12158	AA, ●	135	3.5 / 350	--	30	17 - 22	56321	CWH	4-FLAT	E28	60	56236	6	
	EXCL. SX MODELS	2	13281	AA, ●	35	3.5 / 525	--	30	11 - 16	56251	CWH	4-FLAT	E30	45	56496	5		
		11 - 16	2	13120	AA, ●	37	3.5 / 525	5.2 / 525	30	05 - 10	55529	CWH	4-FLAT	T43	E10	5	56496	4
		11 - 15	1.25	12030	AA, ●	129	3.5 / 350	--	30									
			2	13066	BB, ●	25	3.5 / 350	--	30									
--	04 - 10	1.25	12126	AA, ●	145	3.5 / 300	--	30										
CONVERTIBLE	2	13526	AA, ●	37	3.5 / 350	--	30											
TELLURIDE	--	20 - 24	2	13420	AA, M, V, ●	55	5.0 / 750	6.0 / 750	45	23 - 24	56490	CWH	4-FLAT	T58	E25	45	56236	10
											56501	CWH	4-FLAT	T59	E25	45	56236	10
										20 - 22	56420	CWH	4-FLAT	E16	5	56236	10	
											56466	CWH	7-WAY	E23		56236	10	
LAND ROVER																		
DISCOVERY SPORT	EXCL. 5+2 SEATING	15 - 19	2	13396	AA, M, V, ●	69	4.5 / 675	--	45	15 - 19	56297	CWH	4-FLAT	E22	45	56496	5	
LR2	--	08 - 15	2	13052	BB, M, ●	25	4.0 / 400	4.0 / 400	30	08 - 10	--	--				56496	5	
LR3	--	05 - 09	2	13456	I, M, ●	67	6.0 / 600	8.0 / 800	30	05 - 09	--	--				56496	5	
LR4	--	10 - 16	2	13456	I, M, ●	67	6.0 / 600	8.0 / 800	30	10 - 12	--	--				--	10	
RANGE ROVER EVOQUE	EXCL. CONVERTIBLE	12 - 19	2	13128	AA, ●	29	4.0 / 600	--	30	12 - 14	56159	CWH	4-FLAT	E4	5	--	1	
RANGE ROVER SPORT	EXCL. HYBRID	14 - 22	2	13243	AA, D, ●	56	8.0 / 800	--	45	15 - 22	56293	CWH	4-FLAT	E5	5	--	--	
	HSE	06 - 13	2	13456	I, M, ●	67	6.0 / 600	8.0 / 800	30	06 - 10	--	--				56496	5	
LEXUS																		
CT200H	--	11 - 17	1.25	11200	BB, M, ●	149	2.0 / 200	--	30	11 - 17	56099	CWH	4-FLAT	E16	20	56496	5	
ES300	--	97 - 03	1.25	12339	BB	153	3.5 / 300	--	30	97 - 03	--	--				56496	5	
ES300H	--	19 - 24	1.25	11576	AA, HE, V	145	2.0 / 200	--	60	22 - 23	56350	CWH	4-FLAT	E22	45	56236	5	
		13 - 18	1.25	11362	BB, M, V, ●	145	2.0 / 200	--	60	13 - 21	56430	CWH	4-FLAT	E20	45	--	10	
		02 - 06	1.25	12339	BB	153	3.5 / 300	--	30	02 - 06	--	--				56496	5	
ES330	--	02 - 06	1.25	12339	BB	153	3.5 / 300	--	30	02 - 06	--	--				56496	5	
ES350	EXCL. F SPORT	19 - 24	1.25	11576	AA, HE, V	145	2.0 / 200	--	60	19 - 23	56350	CWH	4-FLAT	E22	45	56236	5	
	--	13 - 18	1.25	11362	BB, M, V, ●	145	2.0 / 200	--	60	13 - 18	56430	CWH	4-FLAT	E20	45	--	10	
	07 - 12	1.25	12343	BB, V, ●	145	3.5 / 350	--	45	07 - 12	--	--				56496	5		
GS300	--	18 - 19	1.25	11366	AA, FR, Q, V, ●	159	2.0 / 200	--	90	18 - 18	--	--				56236	5	
		06 - 06	1.25	11372	M, V, ●	145	2.0 / 200	--	45	98 - 06	--	--				56496	5	
GS350	--	13 - 20	1.25	11366	AA, FR, Q, V, ●	159	2.0 / 200	--	90	13 - 18	--	--				56236	5	
		07 - 11	1.25	11372	M, V, ●	145	2.0 / 200	--	45	07 - 09	--	--				56496	5	
GS430	--	06 - 07	1.25	11372	M, V, ●	145	2.0 / 200	--	45	01 - 05	--	--				56496	5	
GX460	--	10 - 23	2	13043	●	17	5.0 / 500	5.0 / 500	30	--	--	--				--	--	
GX470	--	03 - 09	2	13445	M, ●	59	5.0 / 500	5.5 / 550	30	03 - 09	--	--				56496	5	
IS200T	--	16 - 17	1.25	11389	BB, M, V, ●	135	2.0 / 200	--	30	16 - 16	56142	CWH	4-FLAT	E20	40	56496	5	
IS250	SEDAN	14 - 15	1.25	11389	BB, M, V, ●	135	2.0 / 200	--	30	09 - 15	56142	CWH	4-FLAT	E20	40	56496	5	
		06 - 13	1.25	11372	M, V, ●	145	2.0 / 200	--	45	06 - 08	--	--				56496	5	
IS300	--	16 - 20	1.25	11389	BB, M, V, ●	135	2.0 / 200	--	30	01 - 05	--	--				56496	5	
IS350	CONVERTIBLE	14 - 15	1.25	11389	BB, M, V, ●	135	2.0 / 200	--	30	--	--	--				--	--	
	SEDAN	14 - 20	1.25	11389	BB, M, V, ●	135	2.0 / 200	--	30	09 - 16	56142	CWH	4-FLAT	E20	40	56496	5	
		06 - 12	1.25	11372	M, V, ●	145	2.0 / 200	--	45	06 - 08	--	--				56496	5	
LS430	--	01 - 06	1.25	12231	●	177	2.5 / 250	--	40	01 - 06	--	--				56496	5	
LS460	--	12 - 17	1.25	12114	AA, FR, Q, V, ●	147	3.5 / 350	--	90	12 - 13	--	--				56236	6	
LX450	--	96 - 97	2	13089	BB, ●	67	5.0 / 500	6.0 / 600	30	96 - 97	--	--				56496	5	
LX470	--	98 - 07	2	13443	●	65	5.0 / 500	6.0 / 600	30	01 - 07	55245	REPL	4-FLAT	T2	E5	5	56496	2
										98 - 99	55365	CWH	4-FLAT	E9	5	56496	5	
LX570	FACTORY EQUIPPED HITCH. ELECTRICAL INFO. ONLY	08 - 11	--	--	--	--	--	--	--	08 - 11	55245	REPL	4-FLAT	E5	5	56496	2	

TRAILER HITCH APPLICATION GUIDE FOOTNOTE KEY

For the most up-to-date application information, please visit curtmfg.com

A Allow additional installation time	CC Roll pan mods required	F Will not fit vehicles with ground effects	HE Hole enlargement required	L Fixed draw bar	Q Temporary bumper removal	TG Compatible with Tommy Gate lifts	VT Vertical receiver tube
AA Main body concealed	CF Carbide black finish	FR Temporary bumper fascia removal	I Will not fit with full size spare	M Round tube main body	R Boxed due to bolt-on arms	U May require battery removal	W Only with boxed rear bumper
B Relocate or modify exhaust	D Minor fascia trim required	G Add'l install w/ load level air compressors	J No spare tire relocation	N Continued while supplies last	S May interfere hands free liftgate sensor	V Under-car trim (not fascia) req'd	● No drilling required
BB Main body exposed	E Noticeable fascia trim required	H Will not fit vehicles with twin tailpipes	K OEM-style hitch	P Not with roll pan bumper	T Modifications required (minor)	X 158" WB models require brace removal, 118" WB models require spare tire reloc.	



TRAILER HITCHES

For 1.25" ordering options, see page 32

CUSTOM WIRING

No splicing required

CWH - For vehicles without OE tow package

ADD - Adds to OE tow package

REPL - Replacement for OE tow package

Splice-in Converters

Make / Model	Style / Notes	Years	Rec. Size	Part#	Foot Note	PC	GTW / TW	WD / WDTW	INS	CUSTOM WIRING						Part#	Sys. Note		
										Years	Part#	Prod Type	Plug	FN	PC			INS	
LEXUS (CONTINUED)																			
NX200T	--	17 - 17	1.25	12172	BB, M, ●	147	3.5 / 350	--	30	15 - 17	56268	CWH	4-FLAT	E19	45	56496	5		
		15 - 17	2	13337	BB, M, ●	29	3.5 / 525	4.0 / 525	30										
		15 - 16	1.25	12143	BB, N, ●	153	3.5 / 350	--	30										
NX250	--	22 - 25	2	13498	BB, M, ●	45	2.0 / 200	--	30	--	--	--				--	--		
NX300	--	18 - 21	1.25	12172	BB, M, ●	147	3.5 / 350	--	30	--	--	--				--	--		
			2	13337	BB, M, ●	29	3.5 / 525	4.0 / 525	30										
NX300H	--	17 - 21	1.25	12172	BB, M, ●	147	3.5 / 350	--	30	15 - 21	56268	CWH	4-FLAT	E19	45	56496	5		
		15 - 21	2	13337	BB, M, ●	29	3.5 / 525	4.0 / 525	30										
		15 - 16	1.25	12143	BB, N, ●	153	3.5 / 350	--	30										
NX350	EXCL. F SPORT	22 - 25	2	13498	BB, M, ●	45	2.0 / 200	--	30	--	--	--				--	--		
NX350H	--	22 - 24	2	13498	BB, M, ●	45	2.0 / 200	--	30	--	--	--				--	--		
NX450H+	EXCL. F SPORT	22 - 24	2	13498	BB, M, ●	45	2.0 / 200	--	30	--	--	--				--	--		
RX300	--	99 - 03	2	13429	BB, ●	49	3.5 / 350	--	30	01 - 03	55245	REPL	4-FLAT	T2	E5	5	56496	2	
RX330	--	04 - 06	2	13530	M, ●	45	3.5 / 350	4.0 / 400	30	04 - 06	55563	CWH	4-FLAT		E18	20	56496	5	
RX350	--	23 - 24	2	13579	AA, ●	49	3.5 / 350	--	30	10 - 23	56083	REPL	4-FLAT	T8	E5	5	56496	5	
		EXCL. F SPORT	16 - 22	2	13515	AA, D, V, ●	29	4.0 / 525	4.0 / 525	75	07 - 12	55563	CWH	4-FLAT		E18	20		
		--	16 - 19	2	13272	AA, ●	29	4.0 / 600	5.0 / 600	30									
		--	10 - 15	2	13143	AA, V, ●	39	4.0 / 600	5.0 / 600	35									
		--	07 - 09	2	13530	M, ●	45	3.5 / 350	4.0 / 400	30									
RX350H	--	23 - 24	2	13579	AA, ●	49	3.5 / 350	--	30	--	--	--				--	--		
RX350L	EXCL. TWIN EXHAUST TIPS	18 - 22	2	13394	AA, D, ●	56	5.0 / 500	--	30	10 - 23	56083	REPL	4-FLAT	T8	E5	5	56496	5	
RX400H	--	06 - 08	2	13530	M, ●	45	3.5 / 350	4.0 / 400	30	06 - 08	--	--					56496	5	
RX450H	EXCL. F SPORT	16 - 22	2	13515	AA, D, V, ●	29	4.0 / 525	4.0 / 525	75	10 - 22	56083	REPL	4-FLAT	T8	E5	5	56496	2	
		16 - 20	2	13282	AA, V, ●	46	4.0 / 600	5.0 / 600	30										
		--	10 - 15	2	13143	AA, V, ●	39	4.0 / 600	5.0 / 600										35
RX500H	--	23 - 24	2	13579	AA, ●	49	3.5 / 350	--	30	--	--	--				--	--		
RZ450E	--	23 - 24	2	13546	AA, D, HE, ●	55	0.0 / 200	--	90	--	--	--				--	--		
TX350	--	24 - 24	2	13519	AA, ●	53	5.0 / 500	--	20	24 - 24	56524	CWH	4-FLAT		E26	30	56496	5	
TX500H	--	24 - 24	2	13519	AA, ●	53	5.0 / 500	--	20	24 - 24	56524	REPL	4-FLAT	T2	E5	5	56496	5	
											56524	CWH	4-FLAT		E26	30			
											55245	REPL	4-FLAT	T2	E5	5			
TX550H+	--	24 - 24	2	13519	AA, ●	53	5.0 / 500	--	20	24 - 24	56524	CWH	4-FLAT		E26	30	56496	5	
UX250H	--	19 - 24	2	13583	BB, HE, ●	67	2.0 / 300	--	50	19 - 24	56506	CWH	4-FLAT		E28	45	56236	5	
																			UX300H
LINCOLN																			
AVIATOR	--	20 - 24	2	13438	AA, D, V, ●	39	6.0 / 600	--	60	20 - 25	56453	CWH	4-FLAT		E23	45	56236	5	
		FITS BENEATH FACTORY 1-1/4" RECEIVER	03 - 05	2	13550	M, ●	56	5.0 / 500	8.0 / 800	40	03 - 04	55344	CWH	4-FLAT		E11	10	--	1
			03 - 05	55251	REPL	4-FLAT	T2	E3	5	--	1								
CONTINENTAL	EXCL. DUAL EXHAUST	88 - 94	1.25	12232	●	161	3.5 / 300	--	30	88 - 94	--	--					56496	2	
CORSAIR	EXCL. PHEV	20 - 24	2	13454	AA, HE, ●	51	3.5 / 525	--	30	20 - 24	--	--					56236	10	
LS	--	00 - 06	1.25	12253	AA, N	167	3.5 / 350	--	30	--	--	--					--	9	
MARK LT	--	06 - 08	2	13360	●	29	6.0 / 600	10 / 1000	30	--	--	--					--	--	
			2	13365	M, ●	37	6.0 / 600	10 / 1000	30										
			2	14360	BB, ●	49	10 / 1000	12 / 1200	30										
MARK VI	--	80 - 83	1.25	12130	AA	155	3.5 / 350	--	30	80 - 93	--	--					--	1	
			2	13707	AA	51	4.0 / 400	6.0 / 600	30										
MKC	--	15 - 19	1.25	12096	AA	155	3.5 / 350	--	45	15 - 19	56262	CWH	4-FLAT		E16	40	56496	2	
			2	13194	AA, HE, R	45	3.5 / 525	5.0 / 525	45										
MKS	--	09 - 16	1.25	12088	AA, ●	147	3.5 / 350	--	30	13 - 16	56093	CWH	4-FLAT		E17	45	56496	5	
			09 - 10	56064	CWH	4-FLAT		E17	40	56496	5								
MKT	WITH ECOBOOST	10 - 17	2	13110	BB, M, ●	61	4.0 / 400	4.0 / 400	40	10 - 19	56095	CWH	4-FLAT		E17	45	56496	2	

CUSTOM WIRING APPLICATION GUIDE FOOTNOTE KEY						For the most up-to-date application information, please visit curtmfg.com					
T1 Multiple parts available. Visit curtmfg.com	T5 Adds 4-flat to factory equipped 7-way	T9 Without factory tow package	T13 Excluding right hand drive	T17 Single rear wheels	T21 Excluding LTZ						
T2 Replaces factory connector with 4-flat	T6 Without LED taillights	T10 Hybrid only	T14 All wheel drive (AWD) models only	T18 SE models only	T22 Excluding plug-in models						
T3 Replaces factory connector with 6-way	T7 With LED taillights	T11 Excluding hybrid	T15 Excluding Grand Touring	T19 Excluding SE models	See page 33 for T23 - T63 footnote key comments						
T4 Replaces factory connector with 7-way	T8 With factory tow package	T12 Excluding EX and Limited	T16 WRX only	T20 Limited 2.0L and EX 2.0L models only	See page 33 for 'Electrical System Notes'						



TRAILER HITCHES

For 1.25" ordering options, see page 32

CUSTOM WIRING

No splicing required

CWH - For vehicles without OE tow package

ADD - Adds to OE tow package

REPL - Replacement for OE tow package

Splice-in Converters

Make / Model	Style / Notes	Years	Rec. Size	Part#	Foot Note	PC	GTW / TW	WD / WDTW	INS	CUSTOM WIRING						Splice-in Converters		
										Years	Part#	Prod Type	Plug	FN	PC	INS	Part#	Sys. Note
LINCOLN (CONTINUED)																		
MKX	--	16 - 18	2	13452	AA, FR, T, ●	45	4.5 / 675	4.5 / 675	45	16 - 18	56298	CWH	4-FLAT	E15	45	56496	5	
	FITS BENEATH FACTORY 1-1/4" RECEIVER	07 - 15	1.25	12036	BB, M, V	145	3.5 / 350	--	60	11 - 15	56121	CWH	4-FLAT	E22	45	56496	2	
		2	13067	BB, V	46	4.0 / 400	--	60	07 - 10	56329	CWH	4-FLAT	E22	45	56236	2		
MKZ	EXCL. 3.0L AWD	17 - 20	1.25	12091	AA, ●	125	3.5 / 350	--	30	13 - 20	56258	CWH	4-FLAT	E20	30	56496	2	
	3.0L AWD ONLY	17 - 17	1.25	12164	AA, T, ●	155	3.5 / 350	--	30	07 - 09	--	--	--	--	--	56496	5	
	--	13 - 16	1.25	12091	AA, ●	125	3.5 / 350	--	30									
	--	10 - 12	1.25	11390	AA	137	2.0 / 200	--	30									
	--	07 - 09	1.25	11329	AA	161	2.0 / 200	--	45									
NAUTILUS	--	24 - 24	2	13613	AA, D, V, ●	53	3.5 / 3.5	--	60	19 - 23	56446	CWH	4-FLAT	E27	45	56236	7	
	--	19 - 23	2	13452	AA, FR, T, ●	45	4.5 / 675	4.5 / 675	45									
NAVIGATOR	--	98 - 02	2	13049	●	51	6.0 / 600	10 / 1000	30	98 - 03	55344	CWH	4-FLAT	E11	10	--	1	
	--		2	13125	M, ●	59	5.0 / 500	7.5 / 750	30									
TOWN CAR	--	81 - 11	1.25	12130	AA	155	3.5 / 350	--	30	81 - 09	--	--	--	--	--	56496	2	
	--	2	13707	AA	51	4.0 / 400	6.0 / 600	30										
ZEPHYR	--	06 - 06	1.25	11329	AA	161	2.0 / 200	--	45	06 - 06	--	--	--	--	--	56496	5	
MAZDA																		
2	--	11 - 15	1.25	11073	BB, M, ●	129	1.5 / 150	--	30	11 - 14	56016	CWH	4-FLAT	E17	30	56496	5	
3	HATCHBACK	19 - 25	1.25	11633	AA, HE, ●	133	2.0 / 200	--	30	19 - 24	56435	CWH	4-FLAT	E22	45	56496	5	
		14 - 18	1.25	11377	BB, D, M, ●	129	2.0 / 200	--	45	14 - 18	55567	CWH	4-FLAT	E17	25	56496	5	
		10 - 13	1.25	11383	●	135	2.0 / 200	--	30	04 - 13	56011	CWH	4-FLAT	T15	E13	20	56496	4
		04 - 09	1.25	11386	AA	133	2.0 / 200	--	30									
	SEDAN	19 - 21	1.25	11636	AA, HE, ●	135	2.0 / 200	--	30	19 - 24	56435	CWH	4-FLAT	E22	45	56496	5	
		14 - 18	1.25	11377	BB, D, M, ●	129	2.0 / 200	--	45	14 - 18	55567	CWH	4-FLAT	E17	25	56496	5	
		10 - 13	1.25	11393	AA, ●	137	2.0 / 200	--	30	04 - 13	56011	CWH	4-FLAT	T15	E13	20	56496	4
		04 - 09	1.25	11386	AA	133	2.0 / 200	--	30									
5	--	12 - 15	1.25	11127	BB, HE, M, V	133	2.0 / 200	--	45	12 - 15	56016	CWH	4-FLAT	E17	30	56496	5	
	SPORT ONLY	06 - 10	1.25	11338	AA, HE, N, ●	137	2.0 / 200	--	45	06 - 10	56016	CWH	4-FLAT	E17	30	56496	5	
6	SEDAN	14 - 21	1.25	11356	BB, M, ●	133	2.0 / 200	--	30	18 - 21	56300	CWH	4-FLAT	E18	45	56496	5	
		06 - 08	1.25	11329	AA	161	2.0 / 200	--	45	14 - 17	56280	CWH	4-FLAT	E18	45	56496	5	
				03 - 08	55567	CWH	4-FLAT	E17	25	56496	5							
626	HATCHBACK	83 - 92	1.25	11239	AA, D, N	145	2.0 / 200	--	50	83 - 92	--	--	--	--	--	56496	4	
	SEDAN	83 - 92	1.25	11239	AA, D, N	145	2.0 / 200	--	50	83 - 92	--	--	--	--	--	56496	4	
B2300	01 - 05 MODELS ARE NO DRILL	01 - 09	1.25	12012	BB	145	3.5 / 350	--	30	94 - 08	55325	CWH	4-FLAT	E13	5	56496	4	
		2	13019	BB	29	4.0 / 400	6.0 / 600	30	98 - 01	55241	REPL	4-FLAT	T2	E4	5	56496	4	
		2	13138	BB, M	33	4.0 / 400	6.0 / 600	30										
	--	94 - 97	1.25	12012	BB	145	3.5 / 350	--	30									
			2	13019	BB	29	4.0 / 400	6.0 / 600	30									
			2	13138	BB, M	33	4.0 / 400	6.0 / 600	30									
B2500	00 - 01 MODELS ARE NO DRILL	98 - 01	1.25	12012	BB	145	3.5 / 350	--	30	98 - 01	55241	REPL	4-FLAT	T2	E4	5	56496	4
		2	13019	BB	29	4.0 / 400	6.0 / 600	30										
		2	13138	BB, M	33	4.0 / 400	6.0 / 600	30										
B3000	00 - 05 MODELS ARE NO DRILL	98 - 07	1.25	12012	BB	145	3.5 / 350	--	30	94 - 08	55325	CWH	4-FLAT	E13	5	56496	4	
		2	13019	BB	29	4.0 / 400	6.0 / 600	30	98 - 01	55241	REPL	4-FLAT	T2	E4	5	56496	4	
		2	13138	BB, M	33	4.0 / 400	6.0 / 600	30										
	--	94 - 96	1.25	12012	BB	145	3.5 / 350	--	30									
			2	13019	BB	29	4.0 / 400	6.0 / 600	30									
			2	13138	BB, M	33	4.0 / 400	6.0 / 600	30									
B4000	00 - 05 MODELS ARE NO DRILL	94 - 09	1.25	12012	BB	145	3.5 / 350	--	30	94 - 08	55325	CWH	4-FLAT	E13	5	56496	4	
		2	13019	BB	29	4.0 / 400	6.0 / 600	30	98 - 01	55241	REPL	4-FLAT	T2	E4	5	56496	4	
		2	13138	BB, M	33	4.0 / 400	6.0 / 600	30										
CX-3	--	16 - 21	1.25	11418	AA, ●	135	2.0 / 200	--	30	16 - 21	56300	CWH	4-FLAT	E18	45	56496	5	

TRAILER HITCH APPLICATION GUIDE FOOTNOTE KEY								For the most up-to-date application information, please visit curtmfg.com							
A Allow additional installation time	CC Roll pan mods required	F Will not fit vehicles with ground effects	HE Hole enlargement required	L Fixed draw bar	Q Temporary bumper removal	TG Compatible with Tommy Gate lifts	VT Vertical receiver tube	AA Main body concealed	CF Carbide black finish	FR Temporary bumper fascia removal	I Will not fit with full size spare	M Round tube main body	R Boxed due to bolt-on arms	U May require battery removal	W Only with boxed rear bumper
B Relocate or modify exhaust	D Minor fascia trim required	G Add'l install w/ load level air compressors	J No spare tire relocation	N Continued while supplies last	S May interfere hands free liftgate sensor	V Under-car trim (not fascia) req'd	● No drilling required	BB Main body exposed	E Noticeable fascia trim required	H Will not fit vehicles with twin tailpipes	K OEM-style hitch	P Not with roll pan bumper	T Modifications required (minor)	X 158" WB models require brace removal, 118" WB models require spare tire reloc.	





TRAILER HITCHES

For 1.25" ordering options, see page 32

CUSTOM WIRING

No splicing required

CWH - For vehicles without OE tow package

ADD - Adds to OE tow package

REPL - Replacement for OE tow package

Splice-in Converters

Make / Model	Style / Notes	Years	TRAILER HITCHES							CUSTOM WIRING								
			Rec. Size	Part#	Foot Note	PC	GTW / TW	WD / WDTW	INS	Years	Part#	Prod Type	Plug	FN	PC	INS	Part#	Sys. Note
MAZDA (CONTINUED)																		
CX-5	--	13 - 24	1.25	12170	AA, ●	129	3.5 / 350	--	30	22 - 25	56487	CWH	4-FLAT	E23	4	--	10	
	EXCL. DIESEL	13 - 23	2	13315	AA, ●	29	4.0 / 600	--	30	17 - 21	56377	CWH	4-FLAT	E21	45	56496	5	
CX-7	--	07 - 12	1.25	12093	AA, N	149	3.5 / 300	--	30	07 - 12	55593	CWH	4-FLAT	T2	E11	25	56496	5
			2	13593	AA	46	3.5 / 350	--	30	07 - 12	55567	CWH	4-FLAT		E17	25	56496	5
			1.25	12156	AA, ●	137	3.5 / 350	--	30	16 - 23	56338	CWH	4-FLAT		E12	45	56496	5
CX-9	--	16 - 23	2	13284	AA, ●	43	4.0 / 600	5.0 / 600	30	07 - 15	56016	CWH	4-FLAT		E17	30	56496	5
			1.25	12112	BB, ●	159	3.5 / 350	--	30									
			2	13575	AA, ●	51	4.0 / 400	--	45									
CX-30	--	20 - 24	1.25	11599	AA, HE, ●	145	2.0 / 200	--	40	20 - 24	56450	CWH	4-FLAT		E26	45	--	10
CX-50	--	23 - 24	1.25	12203	AA, V, ●	155	3.5 / 525	--	60	23 - 24	56487	CWH	4-FLAT		E23	4	--	10
			2	13510	AA, V, ●	41	3.5 / 525	--	60									
CX-70	--	25 - 25	2	13568	AA, HE, ●	49	5.0 / 800	5.0 / 500	30	25 - 25	56494	CWH	4-FLAT		E23	45	56236	10
CX-90	--	24 - 24	2	13568	AA, HE, ●	49	5.0 / 800	5.0 / 500	30	24 - 25	56494	CWH	4-FLAT		E23	45	56236	10
MIATA	--	99 - 05	1.25	11749	AA, N	183	2.0 / 200	--	40	90 - 05	--	--					56496	4
		90 - 97	1.25	11746	AA, HE, N, VT, ●	187	2.0 / 200	--	45									
MX-5 MIATA	--	16 - 22	1.25	11435	AA, HE, ●	167	2.0 / 200	--	45	16 - 24	56300	CWH	4-FLAT		E18	45	56496	5
		06 - 15	1.25	11028	AA, D, HE	171	2.0 / 200	--	90	06 - 15	56082	CWH	4-FLAT		E13	20	56496	5
MX-6	--	88 - 92	1.25	11239	AA, D, N	145	2.0 / 200	--	50	88 - 92	--	--					56496	4
NAVAJO	--	91 - 94	2	13033	I	45	5.0 / 500	6.0 / 600	30	91 - 94	--	--					--	1
			2	13540	M	43	4.0 / 400	6.0 / 600	35									
TRIBUTE	WITH FACTORY 1-1/4" RECEIVER HITCH	08 - 11	2	13651	B, M	56	3.5 / 350	5.0 / 500	60	08 - 11	56329	CWH	4-FLAT		E22	45	56236	2
		05 - 06	2	13651	B, M	56	3.5 / 350	5.0 / 500	60	05 - 07	56345	CWH	4-FLAT		E22	45	56236	5
	WITHOUT FACTORY 1-1/4" RECEIVER HITCH	08 - 11	1.25	12060	M	153	3.5 / 350	--	30	01 - 04	55255	REPL	4-FLAT	T2	E1	5	56496	4
		2	13650	M	47	3.5 / 350	5.0 / 500	30	01 - 03	55343	CWH	4-FLAT		E17	10	56496	4	
	05 - 06	1.25	12060	M	153	3.5 / 350	--	30										
		2	13650	M	47	3.5 / 350	5.0 / 500	30										
01 - 04	2	13506	M	46	3.5 / 350	5.0 / 500	30											
MERCEDES-BENZ																		
C63 AMG	--	08 - 13	1.25	11030	AA	163	2.0 / 200	--	30	08 - 10	--	--					56236	10
C250	--	12 - 13	1.25	11030	AA	163	2.0 / 200	--	30	10 - 10	--	--					56236	10
C300	SEDAN	15 - 20	1.25	11485	AA, D, FR, Q, ●	147	2.0 / 200	--	90	08 - 10	--	--					56236	10
		08 - 13	1.25	11030	AA	163	2.0 / 200	--	30									
C350	--	08 - 13	1.25	11030	AA	163	2.0 / 200	--	30	08 - 10	--	--					56236	10
CLA250	--	16 - 18	1.25	12163	AA, V, ●	163	3.5 / 350	--	30	16 - 16	--	--					56496	5
CLS63 AMG	--	08 - 13	1.25	11030	AA	163	2.0 / 200	--	30	08 - 10	--	--					56236	10
CLS550	--	08 - 13	1.25	11030	AA	163	2.0 / 200	--	30	08 - 10	--	--					56236	10
E55 AMG	SEDAN AND WAGON	03 - 06	1.25	11701	AA	175	2.0 / 200	--	30	03 - 06	--	--					--	10
E63 AMG	SEDAN AND WAGON	07 - 09	1.25	11701	AA	175	2.0 / 200	--	30	07 - 09	--	--					--	10
E300	--	17 - 19	1.25	11454	AA, HE	161	2.0 / 200	--	45	17 - 19	--	--					56236	10
E320	SEDAN, EXCL. SPORT	03 - 09	1.25	11701	AA	175	2.0 / 200	--	30	03 - 09	--	--					--	10
	WAGON	98 - 03	1.25	11830	AA, N	194	2.0 / 200	--	60	98 - 03	--	--					56496	5
E350	SEDAN	20 - 23	1.25	11454	AA, HE	161	2.0 / 200	--	45	20 - 20	--	--					--	10
		10 - 16	1.25	11001	AA	163	2.0 / 200	--	30	11 - 11	--	--					56236	10
	SEDAN, EXCL. SPORT	06 - 09	1.25	11701	AA	175	2.0 / 200	--	30	03 - 09	--	--					--	10
WAGON	06 - 09	1.25	11701	AA	175	2.0 / 200	--	30	06 - 09	--	--					--	10	
E400	--	17 - 19	1.25	11454	AA, HE	161	2.0 / 200	--	45	--	--	--					--	10
E450	SEDAN	20 - 23	1.25	11454	AA, HE	161	2.0 / 200	--	45	--	--	--					--	10
E500	SEDAN	03 - 06	1.25	11701	AA	175	2.0 / 200	--	30	03 - 06	--	--					--	10
E550	SEDAN, EXCL. SPORT	07 - 09	1.25	11701	AA	175	2.0 / 200	--	30	07 - 09	--	--					--	10

CUSTOM WIRING APPLICATION GUIDE FOOTNOTE KEY						For the most up-to-date application information, please visit curtmfg.com					
T1 Multiple parts available. Visit curtmfg.com	T5 Adds 4-flat to factory equipped 7-way	T9 Without factory tow package	T13 Excluding right hand drive	T17 Single rear wheels	T21 Excluding LTZ						
T2 Replaces factory connector with 4-flat	T6 Without LED taillights	T10 Hybrid only	T14 All wheel drive (AWD) models only	T18 SE models only	T22 Excluding plug-in models						
T3 Replaces factory connector with 6-way	T7 With LED taillights	T11 Excluding hybrid	T15 Excluding Grand Touring	T19 Excluding SE models	See page 33 for T23 - T63 footnote key comments						
T4 Replaces factory connector with 7-way	T8 With factory tow package	T12 Excluding EX and Limited	T16 WRX only	T20 Limited 2.0L and EX 2.0L models only	See page 33 for 'Electrical System Notes'						



TRAILER HITCHES

For 1.25" ordering options, see page 32

CUSTOM WIRING

No splicing required

CWH - For vehicles without OE tow package

ADD - Adds to OE tow package

REPL - Replacement for OE tow package

Splice-in Converters

Make / Model	Style / Notes	Years	Rec. Size	Part#	Foot Note	PC	GTW / TW	WD / WDTW	INS	CUSTOM WIRING						Part#	Sys. Note
										Years	Part#	Prod Type	Plug	FN	PC		
MERCEDES-BENZ (CONTINUED)																	
G500	--	02 - 08	2	13318	BB, ●	78	5.0 / 500	--	45	02 - 08	--	--				56496	5
GL350	--	10 - 13	2	13102	BB, M, ●	77	3.5 / 350	--	60	10 - 11	--	--				56496	5
GL450	EXCL. ACTIVE CURVE SYSTEM	14 - 16	2	13190	BB, D, V, ●	101	7.5 / 900	--	40	14 - 15	--	--				56496	5
		--	2	13102	BB, M, ●	77	3.5 / 350	--	60	07 - 11	--	--				--	10
GL550	EXCL. ACTIVE CURVE SYSTEM	14 - 16	2	13190	BB, D, V, ●	101	7.5 / 900	--	40	08 - 11	--	--				56496	5
		--	2	13102	BB, M, ●	77	3.5 / 350	--	60								
GLA45 AMG	--	15 - 19	2	13197	AA, ●	51	4.0 / 600	--	60	--	--	--				--	--
GLA250		21 - 24	2	13490	BB, V, ●	39	3.5 / 525	--	90	15 - 21	--	--				56236	10
		15 - 20	2	13197	AA, ●	51	4.0 / 600	--	60								
GLC300	EXCL. FACTORY RECEIVER	21 - 22	2	13477	AA, D, FR, Q, V, ●	46	6.0 / 900	--	45	16 - 16	--	--				56496	5
		16 - 20	2	13290	AA, V, ●	43	6.0 / 900	--	45								
GLC43 AMG	--	17 - 21	2	13290	AA, V, ●	43	6.0 / 900	--	45	--	--	--				--	--
GLE350		16 - 18	2	13411	AA, V, ●	71	7.0 / 700	7.0 / 700	40	17 - 17	--	--				56496	5
			2	13294	AA, ●	37	7.5 / 750	--	60								
GLE43 AMG		17 - 19	2	13411	AA, V, ●	71	7.0 / 700	7.0 / 700	40	18 - 18	--	--				56236	10
			2	13294	AA, ●	37	7.5 / 750	--	60								
GLK250		13 - 15	2	13155	BB, M	79	3.5 / 525	--	45	14 - 15	--	--				56496	5
			2	13142	BB, M	75	3.5 / 350	--	60	13 - 13	--	--				56236	6
GLK350		13 - 15	2	13177	BB, M	77	3.5 / 525	--	45	10 - 15	--	--				56236	10
			2	13142	BB, M	75	3.5 / 350	--	60								
GLS450	EXCL. ACTIVE CURVE SYSTEM	17 - 19	2	13190	BB, D, V, ●	101	7.5 / 900	--	40	--	--	--				--	--
GLS550	EXCL. ACTIVE CURVE SYSTEM	17 - 19	2	13190	BB, D, V, ●	101	7.5 / 900	--	40	--	--	--				--	--
METRIS	--	16 - 23	2	13276	BB, ●	49	6.0 / 900	6.0 / 900	30	16 - 16	--	--				56236	5
ML320	EXCL. AIR RIDE SUSPENSION	07 - 09	2	13342	AA, D, V	67	3.5 / 350	4.0 / 400	60	07 - 08	--	--				56496	5
		--	2	13018	●	35	3.5 / 350	--	30	98 - 02	--	--				56496	5
ML350	EXCL. DIESEL	12 - 15	2	13411	AA, V, ●	71	7.0 / 700	7.0 / 700	40	12 - 12	--	--				--	10
	EXCL. BLUETEC OR AIR RIDE SUSPENSION	06 - 11	2	13342	AA, D, V	67	3.5 / 350	4.0 / 400	60	03 - 08	--	--				56496	5
	BLUETEC 4MATIC	11 - 11	2	13102	BB, M, ●	77	3.5 / 350	--	60								
--	--	03 - 05	2	13018	●	35	3.5 / 350	--	30								
ML430	--	99 - 01	2	13018	●	35	3.5 / 350	--	30	99 - 01	--	--				56496	5
ML500	EXCL. AIR RIDE SUSPENSION	06 - 07	2	13342	AA, D, V	67	3.5 / 350	4.0 / 400	60	06 - 07	--	--				56236	10
		--	2	13018	●	35	3.5 / 350	--	30	02 - 05	--	--				56496	5
ML550	EXCL. AIR RIDE SUSPENSION	08 - 09	2	13342	AA, D, V	67	3.5 / 350	4.0 / 400	60	08 - 08	--	--				56236	10
R320	--	07 - 09	2	13103	AA, V, ●	51	3.5 / 350	--	45	07 - 09	--	--				--	10
R350	--	06 - 12	2	13103	AA, V, ●	51	3.5 / 350	--	45	06 - 10	--	--				56236	10
R500	--	06 - 07	2	13103	AA, V, ●	51	3.5 / 350	--	45	06 - 07	--	--				56236	10
SPRINTER 1500	STANDARD BUMPER	19 - 20	2	13388	BB, ●	69	6.0 / 600	10 / 1000	30	--	--	--				--	--
SPRINTER 2500	STANDARD BUMPER, EXCL. REAR DOOR STEP	10 - 24	2	13388	BB, ●	69	6.0 / 600	10 / 1000	30	10 - 23	--	--				56236	10
	CARGO VAN, EXCL. REAR DOOR STEP	10 - 24	2	13358	BB, K, ●	69	5.0 / 500	7.5 / 750	30								
SPRINTER 3500	STANDARD BUMPER, EXCL. REAR DOOR STEP	10 - 24	2	13388	BB, ●	69	6.0 / 600	10 / 1000	30	10 - 23	--	--				56236	10
	CARGO VAN, 144" WB WITH STEP BUMPER, EXCL. REAR DOOR STEP	10 - 19	2	13375	BB, ●	63	5.0 / 500	7.5 / 750	30								
	CARGO VAN, 170" WB WITH FACTORY STEP BUMPER	10 - 24	2	13358	BB, K, ●	69	5.0 / 500	7.5 / 750	30								
	CARGO VAN, CAB & CHASSIS 170" WHEEL BASE	10 - 11	2	13275	AA, K	59	6.0 / 600	10 / 1000	30								

TRAILER HITCH APPLICATION GUIDE FOOTNOTE KEY For the most up-to-date application information, please visit curtmfg.com

A Allow additional installation time	CC Roll pan mods required	F Will not fit vehicles with ground effects	HE Hole enlargement required	L Fixed draw bar	Q Temporary bumper removal	TG Compatible with Tommy Gate lifts	VT Vertical receiver tube
AA Main body concealed	CF Carbide black finish	FR Temporary bumper fascia removal	I Will not fit with full size spare	M Round tube main body	R Boxed due to bolt-on arms	U May require battery removal	W Only with boxed rear bumper
B Relocate or modify exhaust	D Minor fascia trim required	G Add'l install w/ load level air compressors	J No spare tire relocation	N Continued while supplies last	S May interfere hands free liftgate sensor	V Under-car trim (not fascia) req'd	● No drilling required
BB Main body exposed	E Noticeable fascia trim required	H Will not fit vehicles with twin tailpipes	K OEM-style hitch	P Not with roll pan bumper	T Modifications required (minor)	X 158" WB models require brace removal, 118" WB models require spare tire reloc.	



TRAILER HITCHES

For 1.25" ordering options, see page 32

CUSTOM WIRING

No splicing required

CWH - For vehicles without OE tow package

ADD - Adds to OE tow package

REPL - Replacement for OE tow package

Splice-in Converters

Make / Model	Style / Notes	Years	TRAILER HITCHES							CUSTOM WIRING								
			Rec. Size	Part#	Foot Note	PC	GTW / TW	WD / WDTW	INS	Years	Part#	Prod Type	Plug	FN	PC	INS	Part#	Sys. Note
MERCURY																		
COLONY PARK	--	87 - 91	1.25	12130	AA	155	3.5 / 350	--	30	79 - 91	--	--				--	1	
GRAND MARQUIS	SEDAN	83 - 09	1.25	12130	AA	155	3.5 / 350	--	30	92 - 97	55326	CWH	4-FLAT	E8	20	--	1	
			2	13707	AA	51	4.0 / 400	6.0 / 600	30									
	WAGON	79 - 86	1.25	12130	AA	155	3.5 / 350	--	30	79 - 86	--	--				--	1	
			2	13707	AA	51	4.0 / 400	6.0 / 600	30									
MARAUDER	--	03 - 04	1.25	12130	AA	155	3.5 / 350	--	30	03 - 04	--	--				--	1	
MARINER	WITH FACTORY 1-1/4" RECEIVER HITCH	05 - 11	2	13651	B, M	56	3.5 / 350	5.0 / 500	60	05 - 11	56329	CWH	4-FLAT	E22	45	56236	2	
	WITHOUT FACTORY 1-1/4" RECEIVER HITCH	05 - 11	1.25	12060	M	153	3.5 / 350	--	30									
MILAN	--	10 - 11	1.25	11390	AA	137	2.0 / 200	--	30	06 - 10	--	--				56496	5	
		06 - 09	1.25	11329	AA	161	2.0 / 200	--	45									
MONTEGO	--	05 - 07	2	13542	AA, ●	51	3.5 / 350	4.0 / 400	30	05 - 07	--	--				56496	5	
MONTEREY VAN	--	04 - 07	2	13587	●	61	3.5 / 350	5.0 / 500	30	04 - 07	56073	REPL	4-FLAT	T2	E3	5	--	1
											56673	CWH	4-FLAT		E8	5	--	1
MOUNTAINEER	FITS BENEATH FACTORY 1-1/4" RECEIVER	06 - 10	2	13112	M, ●	46	5.0 / 500	8.0 / 800	30	06 - 10	--	--				--	1	
		02 - 05	2	13550	M, ●	56	5.0 / 500	8.0 / 800	40	02 - 03	55344	CWH	4-FLAT		E11	10	--	1
	--	96 - 01	2	13033	I, ●	45	5.0 / 500	6.0 / 600	30	02 - 05	55251	REPL	4-FLAT	T2	E3	5	--	--
		97 - 01	2	13540	M, ●	43	4.0 / 400	6.0 / 600	35	97 - 01	55345	CWH	4-FLAT		E20	40	56496	5
											55241	REPL	4-FLAT	T2	E4	5	--	--
SABLE	SEDAN	08 - 09	2	13542	AA, ●	51	3.5 / 350	4.0 / 400	30	00 - 03	--	--				--	1	
	SEDAN, EXCL. DUAL EXHAUST	86 - 05	1.25	12232	●	161	3.5 / 300	--	30									
	WAGON, EXCL. DUAL EXHAUST	86 - 05	1.25	12232	●	161	3.5 / 300	--	30									
VILLAGER	--	99 - 02	2	13572	●	65	3.5 / 350	5.0 / 500	35	99 - 02	--	--				56496	4	
MINI																		
COOPER	BASE, HATCHBACK, EXCL. WITH SPARE TIRE	14 - 19	1.25	11417	AA, D, ●	155	2.0 / 200	--	60	02 - 15	--	--				56236	10	
		08 - 14	1.25	11387	AA, D, M	155	2.0 / 200	--	60									
	CLUBMAN AND CLUBMAN S CONVERTIBLE, EXCL. 'S' MODEL	09 - 10	1.25	11160	AA, FR, Q, V, ●	153	2.0 / 200	--	60									
		05 - 08	1.25	11126	AA, FR, Q, ●	165	2.0 / 200	--	60									
	2-DOOR HATCHBACK, EXCL. 'S' MODEL	07 - 11	1.25	11160	AA, FR, Q, V, ●	153	2.0 / 200	--	60									
		02 - 06	1.25	11126	AA, FR, Q, ●	165	2.0 / 200	--	60									
COOPER CLUBMAN	--	16 - 21	1.25	11524	AA, FR, Q, V, ●	153	2.0 / 200	--	90	--	--	--			--	--		
COOPER COUNTRYMAN	--	17 - 24	1.25	11522	AA, FR, Q, ●	159	2.0 / 200	--	90	13 - 13	--	--				56236	10	
		11 - 16	1.25	11333	AA, D, FR, Q, ●	155	2.0 / 200	--	90									
MITSUBISHI																		
ECLIPSE CROSS	--	22 - 24	2	13616	AA, ●	43	3.5 / 525	--	30	18 - 24	56296	REPL	4-FLAT	E11	25	56496	5	
		18 - 21	1.25	12154	B, BB, M, ●	183	3.5 / 350	--	30									
			2	13273	B, BB, M, ●	56	3.5 / 525	--	30									
ENDEAVOR	--	06 - 11	2	13113	●	51	3.5 / 350	5.0 / 500	30	04 - 11	56039	CWH	4-FLAT	E10	15	56496	5	
		04 - 05	2	13569	●	49	3.5 / 350	5.0 / 500	30									
LANCER	HATCHBACK, EXCL. FORE TO AFT MUFFLERS	11 - 14	1.25	11479	HE, ●	145	2.0 / 200	--	30	11 - 14	56127	CWH	4-FLAT	E19	45	56496	5	
	SEDAN, EXCL. RALLIART AND FORE TO AFT MUFFLERS	08 - 17	1.25	11479	HE, ●	145	2.0 / 200	--	30	12 - 17	56127	CWH	4-FLAT	E19	45	56496	5	
	SEDAN, EXCL. RALLIART	13 - 15	1.25	11328	AA, HE, N, ●	129	2.0 / 200	--	30	08 - 11	--	--				56496	4	
	WAGON, EXCL. FORE TO AFT MUFFLERS	10 - 11	1.25	11479	HE, ●	145	2.0 / 200	--	30	10 - 11	56127	CWH	4-FLAT	E19	45	56496	5	
CUSTOM WIRING APPLICATION GUIDE FOOTNOTE KEY																		
For the most up-to-date application information, please visit curtmfg.com																		
T1 Multiple parts available. Visit curtmfg.com	T5 Adds 4-flat to factory equipped 7-way	T9 Without factory tow package	T13 Excluding right hand drive	T17 Single rear wheels	T21 Excluding LTZ													
T2 Replaces factory connector with 4-flat	T6 Without LED taillights	T10 Hybrid only	T14 All wheel drive (AWD) models only	T18 SE models only	T22 Excluding plug-in models													
T3 Replaces factory connector with 6-way	T7 With LED taillights	T11 Excluding hybrid	T15 Excluding Grand Touring	T19 Excluding SE models	See page 33 for T23 - T63 footnote key comments													
T4 Replaces factory connector with 7-way	T8 With factory tow package	T12 Excluding EX and Limited	T16 WRX only	T20 Limited 2.0L and EX 2.0L models only	See page 33 for 'Electrical System Notes'													



TRAILER HITCHES
For 1.25" ordering options, see page 32

CUSTOM WIRING

No splicing required

CWH - For vehicles without OE tow package

ADD - Adds to OE tow package

REPL - Replacement for OE tow package

Splice-in Converters

Main table containing vehicle models, years, and hitch specifications. Includes sections for MITSUBISHI, NISSAN, and various vehicle models like MIRAGE, MONTERO, RANGER, etc.

TRAILER HITCH APPLICATION GUIDE FOOTNOTE KEY

For the most up-to-date application information, please visit curtmfg.com

Footnote key table with columns A through X defining abbreviations for installation requirements, such as 'A Allow additional installation time' and 'X 158" WB models require brace removal'.



TRAILER HITCHES

For 1.25" ordering options, see page 32

CUSTOM WIRING

No splicing required

CWH - For vehicles without OE tow package

ADD - Adds to OE tow package

REPL - Replacement for OE tow package

Splice-in Converters

Make / Model	Style / Notes	Years	TRAILER HITCHES							CUSTOM WIRING							Part#	Sys. Note
			Rec. Size	Part#	Foot Note	PC	GTW / TW	WD / WDTW	INS	Years	Part#	Prod Type	Plug	FN	PC	INS		
NISSAN (CONTINUED)																		
NV3500	--	12 - 21	2	13109	BB, ●	45	7.5 / 750	10 / 1000	30	12 - 21	56148	CWH	4-FLAT	E22	45	56496	5	
			2	14000	BB, ●	63	10 / 1000	12 / 1200	30									
NV200	--	13 - 21	2	13165	BB, D, HE, ●	35	3.5 / 525	--	30	13 - 21	56279	CWH	4-FLAT	E22	45	56496	5	
PATHFINDER	--	22 - 24	2	13512	AA, D, ●	61	6.0 / 900	6.0 / 900	45	22 - 24	56520	CWH	4-FLAT	E10	30	--	10	
		17 - 20	2	13309	AA, D, ●	33	6.0 / 900	6.0 / 900	40	18 - 20	56401	CWH	7-WAY	E31	30	--	--	
		13 - 16	2	13126	AA, D, ●	27	4.0 / 600	5.0 / 600	40	13 - 20	56281	CWH	4-FLAT	E26	30	56236	10	
		96 - 04	2	13088	●	55	5.0 / 500	6.0 / 600	35	13 - 20	56357	CWH	7-WAY	T4	E27	30	56236	10
			2	13156	M, ●	59	5.0 / 500	6.0 / 600	30	05 - 12	56225	CWH	4-FLAT	T2	E17	30	--	1
		87 - 95	2	13095	BB	45	5.0 / 500	6.0 / 600	40	05 - 12	56226	CWH	7-WAY	T4	E30	30	56236	10
										11 - 11	56141	REPL	4-FLAT	N, T2	E4	5	--	1
										05 - 10	55441	REPL	4-FLAT	T2	E4	5	56496	2
								96 - 04	55361	CWH	4-FLAT		E14	20	56496	4		
								87 - 95	55353	CWH	4-FLAT		E14	10	56496	4		
PATHFINDER ARMADA	--	04 - 04	2	13188	M, ●	45	6.0 / 600	10 / 1000	30	--	--	--				--	--	
PICKUP	--	95 - 97	2	13092	R	71	5.0 / 500	6.0 / 600	45	95 - 97	55353	CWH	4-FLAT	E14	10	56496	4	
QASHQAI	--	17 - 23	2	13377	AA, HE, ●	29	3.5 / 525	--	30	--	--	--				--	--	
QUEST	--	11 - 17	2	13078	●	65	3.5 / 300	5.0 / 500	60	11 - 17	56342	CWH	4-FLAT	E23	45	56496	5	
		04 - 09	2	13563	●	63	3.5 / 300	5.0 / 500	30	04 - 09	55570	CWH	4-FLAT	E16	10	56496	4	
		99 - 02	2	13572	●	65	3.5 / 350	5.0 / 500	35	99 - 02	56423	CWH	4-FLAT	E18	5	56496	4	
ROGUE	--	21 - 24	1.25	12202	AA, ●	145	3.5 / 525	--	30	21 - 24	56459	CWH	4-FLAT	E26	45	56496	5	
			2	13471	AA, ●	33	3.5 / 525	--	30	08 - 20	56033	CWH	4-FLAT	E20	30	56496	5	
		EXCL. KROM	08 - 20	1.25	12122	AA, ●	137	3.5 / 350	--	45								
			2	13204	AA, ●	29	3.5 / 525	--	45									
ROGUE SELECT	--	14 - 15	1.25	12122	AA, ●	137	3.5 / 350	--	45	--	--	--				--	--	
			2	13204	AA, ●	29	3.5 / 525	--	45									
ROGUE SPORT	--	17 - 22	2	13377	AA, HE, ●	29	3.5 / 525	--	30	20 - 22	56445	CWH	4-FLAT	E21	45	56496	5	
										17 - 19	56397	CWH	4-FLAT	E23	45	56496	5	
SENTRA	SEDAN, EXCL. SR, SR TURBO AND NISMO	13 - 22	1.25	11349	BB	137	2.0 / 200	--	30	20 - 24	56500	CWH	4-FLAT	E21	45	56496	5	
		07 - 12	1.25	11370	AA	133	2.0 / 200	--	30	13 - 19	56205	CWH	4-FLAT	E19	45	56496	5	
										07 - 12	56022	CWH	4-FLAT	E18	30	56496	5	
TITAN	--	17 - 24	2	13304	BB, M, ●	56	8.0 / 800	12 / 1200	30	--	--	--				--	--	
		04 - 15	2	13199	BB, M, ●	46	6.0 / 600	10 / 1000	30									
TITAN XD	--	16 - 24	2	15306	BB, CF, ●	78	16 / 2400	17 / 2400	30	--	--	--				--	--	
VERSA	SEDAN	12 - 19	1.25	11256	BB, HE, M, V, ●	145	2.0 / 200	--	30	14 - 19	56400	CWH	4-FLAT	E22	45	56496	4	
		07 - 11	1.25	11348	BB, HE, ●	157	2.0 / 200	--	30	14 - 18	56185	CWH	4-FLAT	T6	E17	20	56496	4
										12 - 13	--	--					56496	4
										07 - 11	56021	CWH	4-FLAT	E21	30	56496	5	
										13 - 13	--	--					56496	4
								07 - 12	56021	CWH	4-FLAT	E21	30	56496	5			
VERSA NOTE	--	14 - 19	1.25	11378	AA, D, ●	114	2.0 / 200	--	30	14 - 19	56206	CWH	4-FLAT	E16	30	56496	4	
X-TRAIL	--	05 - 06	1.25	11444	N, Q, ●	153	2.0 / 200	--	60	05 - 06	--	--				56496	5	
XTERRA	--	05 - 15	2	13514	M, ●	47	4.0 / 400	6.0 / 600	30	05 - 15	56225	CWH	4-FLAT	E17	30	--	1	
		00 - 04	2	13183	M, ●	51	4.0 / 400	6.0 / 600	30	05 - 15	55441	REPL	4-FLAT	T2	E4	5	56496	2
										09 - 13	56226	CWH	7-WAY	T4	E30	30	--	10
										00 - 04	55244	REPL	4-FLAT	T2	E2	5	--	2

CUSTOM WIRING APPLICATION GUIDE FOOTNOTE KEY			For the most up-to-date application information, please visit curtmfg.com			
T1 Multiple parts available. Visit curtmfg.com	T5 Adds 4-flat to factory equipped 7-way	T9 Without factory tow package	T13 Excluding right hand drive	T17 Single rear wheels	T21 Excluding LTZ	
T2 Replaces factory connector with 4-flat	T6 Without LED taillights	T10 Hybrid only	T14 All wheel drive (AWD) models only	T18 SE models only	T22 Excluding plug-in models	
T3 Replaces factory connector with 6-way	T7 With LED taillights	T11 Excluding hybrid	T15 Excluding Grand Touring	T19 Excluding SE models	See page 33 for T23 - T63 footnote key comments	
T4 Replaces factory connector with 7-way	T8 With factory tow package	T12 Excluding EX and Limited	T16 WRX only	T20 Limited 2.0L and EX 2.0L models only	See page 33 for 'Electrical System Notes'	



TRAILER HITCHES

For 1.25" ordering options, see page 32

CUSTOM WIRING

No splicing required

CWH - For vehicles without OE tow package

ADD - Adds to OE tow package

REPL - Replacement for OE tow package

Splice-in Converters

Make / Model	Style / Notes	Years	TRAILER HITCHES							CUSTOM WIRING								
			Rec. Size	Part#	Foot Note	PC	GTW / TW	WD / WDTW	INS	Years	Part#	Prod Type	Plug	FN	PC	INS	Part#	Sys. Note
OLDSMOBILE																		
98	SEDAN	80 - 84	1.25	12009	BB	175	3.5 / 350	--	30	80 - 84	--	--					--	1
AURORA	--	01 - 03	1.25	12044	BB, V	157	3.5 / 350	--	30	01 - 03	--	--					--	4
BRAVADA	--	95 - 04	2	13020	●	37	5.0 / 500	6.0 / 600	30	95 - 01	55411	CWH	4-FLAT	E2	15		--	1
			2	13300	M, ●	43	4.0 / 400	6.0 / 600	30									
			2	13083	●	65	5.0 / 500	6.0 / 600	30									
CUSTOM CRUISER	--	77 - 92	1.25	12041	AA	165	3.5 / 350	--	40	91 - 92	--	--					--	1
CUTLASS CIERA CRUISER	--	80 - 83	1.25	12005	BB, HE, ●	177	3.5 / 350	--	45	80 - 83	--	--					--	1
CUTLASS SUPREME	RWD	78 - 88	1.25	12005	BB, HE, ●	177	3.5 / 350	--	45	78 - 88	--	--					--	1
DELTA 88	SEDAN	80 - 85	1.25	12009	BB	175	3.5 / 350	--	30	80 - 85	--	--					--	10
INTRIGUE	--	98 - 02	1.25	12239	AA	159	3.5 / 350	--	45	98 - 02	--	--					--	4
SILHOUETTE	--	97 - 04	2	13344	AA	46	4.0 / 400	6.0 / 600	30	97 - 04	55355	CWH	4-FLAT	E12	10		--	4
PLYMOUTH																		
GRAND VOYAGER	EXCL. STOW 'N GO	96 - 00	1.25	12362	AA	137	3.5 / 350	--	30	96 - 00	55334	CWH	4-FLAT	E17	20		--	4
			1.25	12094	BB, ●	129	3.5 / 350	--	30									
VOYAGER	EXCL. STOW 'N GO	96 - 00	1.25	12362	AA	137	3.5 / 350	--	30	96 - 00	55334	CWH	4-FLAT	E17	20		--	--
			1.25	12094	BB, ●	129	3.5 / 350	--	30									
			2	13362	AA	43	4.0 / 400	5.0 / 500	30									
PONTIAC																		
AZTEK	--	01 - 05	2	13469	BB	39	3.5 / 350	--	30	01 - 05	55383	CWH	4-FLAT	E12	20		--	--
BONNEVILLE	EXCL. SLE	00 - 05	1.25	12044	BB, V	157	3.5 / 350	--	30	92 - 05	--	--					--	--
	--	82 - 86	1.25	12005	BB, HE, ●	177	3.5 / 350	--	45									
FIREBIRD	--	82 - 02	1.25	11117	BB, H	161	2.0 / 200	--	45	82 - 01	--	--					--	--
			1.25	11306	AA	117	2.0 / 200	--	60									
G3	HATCHBACK	09 - 10	1.25	11306	AA	117	2.0 / 200	--	60	09 - 10	--	--					--	--
G5	COUPE	07 - 10	1.25	11447	BB	149	2.0 / 200	--	30	07 - 10	55432	CWH	4-FLAT	E7	15		--	--
	SEDAN	07 - 10	1.25	11447	BB	149	2.0 / 200	--	30									
G6	COUPE AND SEDAN	05 - 10	1.25	12333	AA, N	157	3.5 / 350	--	60	05 - 10	56013	CWH	4-FLAT	E8	20		--	--
GRAND PRIX	EXCL. SE	78 - 87	1.25	12005	BB, HE, ●	177	3.5 / 350	--	45	04 - 08	56076	CWH	4-FLAT	N	E9	15	--	--
										78 - 87	--	--					--	--
LEMANS	SEDAN AND WAGON	78 - 81	1.25	12005	BB, HE, ●	177	3.5 / 350	--	45	78 - 81	--	--					--	--
MONTANA	EXCL. SV6	99 - 09	2	13344	AA	46	4.0 / 400	6.0 / 600	30	99 - 09	55355	CWH	4-FLAT	E12	10		--	--
	SV6 121" WHEELBASE ONLY	05 - 09	2	13336	●	43	4.0 / 400	6.0 / 600	30	05 - 06	56077	CWH	4-FLAT	E5	15		--	--
PARISIENNE	SEDAN	83 - 86	1.25	12009	BB	175	3.5 / 350	--	30	83 - 86	--	--					--	--
PURSUIT	COUPE, EXCL. GT	05 - 06	1.25	11430	BB, U	133	2.0 / 200	--	60	05 - 06	55432	CWH	4-FLAT	E7	15		--	--
	COUPE, GT	05 - 06	1.25	11447	BB	149	2.0 / 200	--	30									
	SEDAN, EXCL. GT	05 - 06	1.25	11430	BB, U	133	2.0 / 200	--	60									
	SEDAN, GT	05 - 06	1.25	11447	BB	149	2.0 / 200	--	30									
TORRENT	--	06 - 09	1.25	12291	●	145	3.5 / 350	--	30	07 - 09	56012	CWH	4-FLAT	E7	15		--	--
			2	13591	M, ●	14	3.5 / 350	4.0 / 400	30									
TRANS SPORT	--	97 - 99	2	13344	AA	46	4.0 / 400	6.0 / 600	30	97 - 99	55355	CWH	4-FLAT	E12	10		--	--
VIBE	GT	03 - 10	1.25	12221	BB, M, ●	137	2.5 / 250	--	30	09 - 10	56035	CWH	4-FLAT	E17	30		--	5
	EXCL. GT	09 - 10	1.25	12228	AA, ●	137	2.5 / 250	--	30									
		03 - 08	1.25	12234	BB, M, ●	137	2.0 / 200	--	30									
PORSCHE																		
CAYENNE	--	20 - 23	2	13592	AA, D, FR, Q, ●	57	6.0 / 600	--	90	20 - 23	--	--					56236	6
		11 - 18	2	13116	AA, FR, Q, ●	51	7.5 / 750	--	75									
		04 - 10	2	13220	A, D, ●	63	6.0 / 600	--	90									
MACAN	EXCL. S	15 - 24	2	13612	AA, D, FR, Q, ●	45	5.0 / 750	--		15 - 23	--	--					56236	5
	--	15 - 18	2	13136	BB, FR, M	45	5.0 / 750	--	45									

TRAILER HITCH APPLICATION GUIDE FOOTNOTE KEY

For the most up-to-date application information, please visit curtmfg.com

A Allow additional installation time	CC Roll pan mods required	F Will not fit vehicles with ground effects	HE Hole enlargement required	L Fixed draw bar	Q Temporary bumper removal	TG Compatible with Tommy Gate lifts	VT Vertical receiver tube
AA Main body concealed	CF Carbide black finish	FR Temporary bumper fascia removal	I Will not fit with full size spare	M Round tube main body	R Boxed due to bolt-on arms	U May require battery removal	W Only with boxed rear bumper
B Relocate or modify exhaust	D Minor fascia trim required	G Add'l install w/ load level air compressors	J No spare tire relocation	N Continued while supplies last	S May interfere hands free liftgate sensor	V Under-car trim (not fascia) req'd	● No drilling required
BB Main body exposed	E Noticeable fascia trim required	H Will not fit vehicles with twin tailpipes	K OEM-style hitch	P Not with roll pan bumper	T Modifications required (minor)	X 158" WB models require brace removal, 118" WB models require spare tire reloc.	



TRAILER HITCHES

For 1.25" ordering options, see page 32

CUSTOM WIRING

No splicing required

CWH - For vehicles without OE tow package

ADD - Adds to OE tow package

REPL - Replacement for OE tow package

Splice-in Converters

Make / Model	Style / Notes	Years	TRAILER HITCHES							CUSTOM WIRING								
			Rec. Size	Part#	Foot Note	PC	GTW / TW	WD / WDTW	INS	Years	Part#	Prod Type	Plug	FN	PC	INS	Part#	Sys. Note
RAM																		
C/V	CARGO VAN	12 - 15	1.25	12264	●	153	3.5 / 350	--	45	12 - 15	56331	CWH	4-FLAT	E23	45	56496	2	
			2	13364	AA, D, ●	16	4.0 / 400	5.0 / 500	30									
PROMASTER 1500	EXCL. REMOTE PROXIMITY KEYLESS ENTRY	22 - 24	2	13295	BB, Q, ●	27	5.0 / 500	--	30	14 - 24	56478	CWH	4-FLAT	E27	45	56236	6	
			14 - 21	2	13295	BB, Q, ●	27	5.0 / 500	--									30
			14 - 23	2	13207	BB, ●	79	6.0 / 750	7.5 / 750									30
PROMASTER 2500	EXCL. REMOTE PROXIMITY KEYLESS ENTRY	22 - 24	2	13295	BB, Q, ●	27	5.0 / 500	--	30	14 - 24	56478	CWH	4-FLAT	E27		56236	6	
			14 - 21	2	13295	BB, Q, ●	27	5.0 / 500	--									30
			14 - 23	2	13207	BB, ●	79	6.0 / 750	7.5 / 750									30
PROMASTER 3500	EXCL. REMOTE PROXIMITY KEYLESS ENTRY	22 - 24	2	13295	BB, Q, ●	27	5.0 / 500	--	30	14 - 24	56478	CWH	4-FLAT	E27		56236	6	
			14 - 21	2	13295	BB, Q, ●	27	5.0 / 500	--									30
			14 - 23	2	13207	BB, ●	79	6.0 / 750	7.5 / 750									30
PROMASTER CITY 1500	--	15 - 22	2	13215	AA, FR, Q, ●	43	3.5 / 350	--	60	15 - 22	56270	CWH	4-FLAT	E29	45	56236	6	
		19 - 25	2	15005	AA, ●	79	15 / 1700	17 / 1700	60	--	--	--				--	--	
1500 CLASSIC	EXCL. FACTORY RECEIVER	19 - 24	19 - 25	2	13419	K, ●	11.5	6.0 / 600	--	30	--	--	--				--	--
			11 - 18	2	13333	K, ●	12	6.0 / 600	10 / 1000	30								
			2	13374	BB, M, ●	51	6.0 / 600	10 / 1000	45									
			2	14374	BB, M, ●	71	10 / 1000	12 / 1200	45									
			2	15572	BB, CF, M, ●	63	15 / 1500	16 / 1600	30									
2500	6' BED, EXCL. FACTORY RECEIVER	11 - 24	2	13361	BB, ●	69	6.0 / 600	10 / 1000	30	--	--	--				--	--	
			2	14361	BB, ●	77	10 / 1000	12 / 1200	30									
			11 - 15	2.5	15704	BB, CF, ●	97	18 / 2700	18 / 2700									30
			11 - 13	2	13333	K, ●	12	6.0 / 600	10 / 1000									30
			16 - 24	2.5	15801	BB, CF, ●	99	20 / 2700	20 / 2700									30
	6' BED, WITH OR WITHOUT FACTORY RECEIVER	14 - 17	2.5	15803	BB, CF, ●	88	20 / 2700	20 / 2700	30	--	--	--				--	--	
			11 - 13	2	15409	BB, CF, ●	89	17 / 2550	17 / 2550									30
			2.5	15809	BB, CF, ●	99	20 / 2700	20 / 2700	30									
			11 - 24	2	13361	BB, ●	69	6.0 / 600	10 / 1000									30
			2	14361	BB, ●	77	10 / 1000	12 / 1200	30									
	8' BED, EXCL. FACTORY RECEIVER	11 - 15	2.5	15704	BB, CF, ●	97	18 / 2700	18 / 2700	30	--	--	--				--	--	
			11 - 13	2	13333	K, ●	12	6.0 / 600	10 / 1000									30
			14 - 17	2.5	15803	BB, CF, ●	88	20 / 2700	20 / 2700									30
			11 - 13	2	15409	BB, CF, ●	89	17 / 2550	17 / 2550									30
			2.5	15809	BB, CF, ●	99	20 / 2700	20 / 2700	30									
8' BED, WITH OR WITHOUT FACTORY RECEIVER	11 - 13	2	15409	BB, CF, ●	89	17 / 2550	17 / 2550	30	--	--	--				--	--		
		2.5	15809	BB, CF, ●	99	20 / 2700	20 / 2700	30										

CUSTOM WIRING APPLICATION GUIDE FOOTNOTE KEY

For the most up-to-date application information, please visit curtmfg.com

T1 Multiple parts available. Visit curtmfg.com	T5 Adds 4-flat to factory equipped 7-way	T9 Without factory tow package	T13 Excluding right hand drive	T17 Single rear wheels	T21 Excluding LTZ
T2 Replaces factory connector with 4-flat	T6 Without LED taillights	T10 Hybrid only	T14 All wheel drive (AWD) models only	T18 SE models only	T22 Excluding plug-in models
T3 Replaces factory connector with 6-way	T7 With LED taillights	T11 Excluding hybrid	T15 Excluding Grand Touring	T19 Excluding SE models	See page 33 for T23 - T63 footnote key comments
T4 Replaces factory connector with 7-way	T8 With factory tow package	T12 Excluding EX and Limited	T16 WRX only	T20 Limited 2.0L and EX 2.0L models only	See page 33 for 'Electrical System Notes'



TRAILER HITCHES

For 1.25" ordering options, see page 32

CUSTOM WIRING

No splicing required

CWH - For vehicles without OE tow package

ADD - Adds to OE tow package

REPL - Replacement for OE tow package

Splice-in Converters

Make / Model	Style / Notes	Years	Rec. Size	Part#	Foot Note	PC	GTW / TW	WD / WDTW	INS	CUSTOM WIRING						Part#	Sys. Note		
										Years	Part#	Prod Type	Plug	FN	PC			INS	
RAM (CONTINUED)																			
3500	6' BED, EXCL. FACTORY RECEIVER	11 - 24	2	13361	BB, ●	69	6.0 / 600	10 / 1000	30	--	--	--					--	--	
			2	14361	BB, ●	77	10 / 1000	12 / 1200	30										
		11 - 15	2.5	15704	BB, CF, ●	97	18 / 2700	18 / 2700	30										
			2	13333	K, ●	12	6.0 / 600	10 / 1000	30										
		6' BED, WITH OR WITHOUT FACTORY RECEIVER	16 - 24	2.5	15801	BB, CF, ●	99	20 / 2700	20 / 2700	30									
				2.5	15803	BB, CF, ●	88	20 / 2700	20 / 2700	30									
	14 - 17		2	15409	BB, CF, ●	89	17 / 2550	17 / 2550	30										
			2.5	15809	BB, CF, ●	99	20 / 2700	20 / 2700	30										
	8' BED, EXCL. FACTORY RECEIVER	11 - 24	2	13361	BB, ●	69	6.0 / 600	10 / 1000	30	--	--	--						--	--
			2	14361	BB, ●	77	10 / 1000	12 / 1200	30										
		11 - 15	2.5	15704	BB, CF, ●	97	18 / 2700	18 / 2700	30										
			2	13333	K, ●	12	6.0 / 600	10 / 1000	30										
8' BED, WITH OR WITHOUT FACTORY RECEIVER		14 - 17	2.5	15803	BB, CF, ●	88	20 / 2700	20 / 2700	30										
			2	15409	BB, CF, ●	89	17 / 2550	17 / 2550	30										
CAB & CHASSIS	11 - 24	2	14070	BB	49	10 / 1000	12 / 1200	45	--	--	--						--	--	
		2	15400	BB, CF	83	17 / 2550	17 / 2550	30											
		2.5	15800	BB, CF	88	20 / 2700	20 / 2700	30											
4500	--	11 - 24	2	14070	BB	49	10 / 1000	12 / 1200	45	--	--	--						--	--
			2	15400	BB, CF	83	17 / 2550	17 / 2550	30										
			2.5	15800	BB, CF	88	20 / 2700	20 / 2700	30										
5500	--	11 - 24	2	14070	BB	49	10 / 1000	12 / 1200	45	--	--	--						--	--
			2	15400	BB, CF	83	17 / 2550	17 / 2550	30										
			2.5	15800	BB, CF	88	20 / 2700	20 / 2700	30										
SAAB																			
9-2X	--	05 - 06	1.25	11497	AA, B, N, ●	155	2.0 / 200	--	30	05 - 06	--	--						56496	5
			1.25	11318	AA, ●	129	2.0 / 200	--	30										
9-3	CONVERTIBLE, SINGLE EXHAUST	03 - 11	1.25	11326	BB, V, ●	177	2.0 / 200	--	60	03 - 11	--	--						56496	5
	SEDAN, SINGLE EXHAUST	03 - 11	1.25	11326	BB, V, ●	177	2.0 / 200	--	60	03 - 11	--	--						56496	5
SATURN																			
AURA	--	07 - 09	1.25	12051	AA	153	3.5 / 300	--	60	07 - 09	--	--						56496	4
ION	RED LINE	04 - 07	1.25	11447	BB	149	2.0 / 200	--	30	03 - 07	56036	CWH	4-FLAT	N	E15	10		56496	4
OUTLOOK	--	07 - 10	2	13424	AA, ●	25	5.0 / 500	6.0 / 600	30	07 - 10	56025	CWH	4-FLAT	N	E7	15		--	1
RELAY	--	05 - 07	2	13336	●	43	4.0 / 400	6.0 / 600	30	06 - 07	56077	CWH	4-FLAT		E5	15		--	1
VUE	--	08 - 10	1.25	12095	AA, M, ●	135	3.5 / 300	--	30	08 - 10	56026	CWH	4-FLAT		E18	30		56496	5
			2	13594	A, M, ●	35	3.5 / 350	4.0 / 400	30	02 - 07	56018	CWH	4-FLAT		E15	15		56496	4
		02 - 07	1.25	12291	D, ●	145	3.5 / 350	--	30										
			2	13591	M, D, ●	14	3.5 / 350	4.0 / 400	30										
SCION																			
IA	--	16 - 16	1.25	11421	BB, HE, M, ●	155	2.0 / 200	--	30	16 - 16	56311	CWH	4-FLAT		E19	45		56496	5
IM	--	16 - 16	1.25	11420	AA, V, ●	149	2.0 / 200	--	45	16 - 16	56309	CWH	4-FLAT		E18	45		56496	5
IQ	--	12 - 15	1.25	11291	AA, HE, ●	141	1.0 / 150	--	30	12 - 12	--	--						56496	4
TC	--	14 - 16	1.25	11375	AA, ●	114	2.0 / 200	--	30	14 - 14	--	--						56496	5
			1.25	11087	AA, ●	125	2.0 / 200	--	30	11 - 11	--	--						56496	4
XA	--	04 - 06	1.25	11488	●	161	2.0 / 200	--	30	05 - 06	--	--						56496	4
XB	--	08 - 15	1.25	12490	AA, ●	145	3.5 / 350	--	30	11 - 15	56035	CWH	4-FLAT		E17	30		56496	5
			1.25	11487	●	145	2.0 / 200	--	30	08 - 10	56062	CWH	4-FLAT		E17	45		56496	5
XD	--	11 - 14	1.25	11134	AA, V, ●	155	2.0 / 200	--	35	04 - 06	56030	CWH	4-FLAT		E14	20		56496	4
			1.25	11134	AA, V, ●	155	2.0 / 200	--	35	08 - 14	56136	CWH	4-FLAT	T6	E17	20		56496	5

TRAILER HITCH APPLICATION GUIDE FOOTNOTE KEY

For the most up-to-date application information, please visit curtmfg.com

A Allow additional installation time	CC Roll pan mods required	F Will not fit vehicles with ground effects	HE Hole enlargement required	L Fixed draw bar	Q Temporary bumper removal	TG Compatible with Tommy Gate lifts	VT Vertical receiver tube
AA Main body concealed	CF Carbide black finish	FR Temporary bumper fascia removal	I Will not fit with full size spare	M Round tube main body	R Boxed due to bolt-on arms	U May require battery removal	W Only with boxed rear bumper
B Relocate or modify exhaust	D Minor fascia trim required	G Add'l install w/ load level air compressors	J No spare tire relocation	N Continued while supplies last	S May interfere hands free liftgate sensor	V Under-car trim (not fascia) req'd	● No drilling required
BB Main body exposed	E Noticeable fascia trim required	H Will not fit vehicles with twin tailpipes	K OEM-style hitch	P Not with roll pan bumper	T Modifications required (minor)	X 158" WB models require brace removal, 118" WB models require spare tire reloc.	



TRAILER HITCHES

For 1.25" ordering options, see page 32

CUSTOM WIRING

No splicing required

CWH - For vehicles without OE tow package

ADD - Adds to OE tow package

REPL - Replacement for OE tow package

Splice-in Converters

Make / Model	Style / Notes	Years	Rec. Size	Part#	Foot Note	PC	GTW / TW	WD / WDTW	INS	Years	Part#	Prod Type	Plug	FN	PC	INS	Part#	Sys. Note	
SMART																			
FORTWO	EXCL. BRABUS	08 - 15	1.25	11020	BB, HE, M	169	2.0 / 200	--	45	08 - 09	--	--					--	1	
SUBARU																			
ASCENT	--	19 - 24	2	13400	AA, HE, M, V, ●	45	5.0 / 675	--	30	19 - 24	56040	CWH	4-FLAT		E11	10	56496	5	
				13448	AA, FR, Q, ●	46	5.0 / 750	5.0 / 750	60										
B9 TRIBECA	--	06 - 07	2	13046	AA, ●	45	3.5 / 350	4.0 / 400	30	06 - 07	55370	CWH	4-FLAT		E11	10	56496	5	
BAJA	--	03 - 06	1.25	11280	BB, ●	153	2.0 / 200	--	30	03 - 06	--	--					56496	5	
CROSSTREK	EXCL. HYBRID	18 - 24	1.25	12184	AA, HE	145	3.5 / 350	--	30	16 - 24	56040	CWH	4-FLAT	T11	E11	10	56496	5	
			2	13382	AA, HE, ●	33	3.5 / 525	--	30	16 - 16	56243	CWH	4-FLAT	T10	E26	45	56496	5	
		--	16 - 17	2	13135	BB, HE, ●	27	3.5 / 525	--	30									
	HYBRID ONLY	16 - 16	2	13135	BB, HE, ●	27	3.5 / 525	--	30										
DL	SEDAN	87 - 89	FLAT	11632	D, L, N	159	1.5 / 150	--	45	87 - 89	--	--					56496	5	
	WAGON	85 - 86	FLAT	11634	L, N	171	2.0 / 200	--	45	85 - 86	--	--					56496	5	
FORESTER	--	19 - 25	1.25	12198	BB, HE	129	3.5 / 350	--	30	09 - 25	56040	CWH	4-FLAT		E11	10	56496	5	
			2	13409	BB, HE, M	27	3.5 / 525	--	30	98 - 08	55370	CWH	4-FLAT		E11	10	56496	5	
			2	13459	AA, D, FR, Q, V, ●	59	3.5 / 350	--	90										
			1.25	12100	BB, M	129	3.5 / 350	--	30										
			2	13144	BB, M	17	3.5 / 525	--	30										
			2	13435	AA, D, V, ●	55	3.5 / 525	--	60										
			1.25	12047	M	133	3.5 / 350	--	30										
			2	13147	BB, HE, M, ●	29	4.0 / 400	--	30										
	1.25	12038	AA, ●	145	3.5 / 350	--	45												
GL	SEDAN	87 - 89	FLAT	11632	D, L, N	159	1.5 / 150	--	45	87 - 89	--	--					56496	5	
	WAGON	85 - 86	FLAT	11634	L, N	171	2.0 / 200	--	45	85 - 86	--	--					56496	5	
GL-10	SEDAN	87 - 89	FLAT	11632	D, L, N	159	1.5 / 150	--	45	87 - 89	--	--					56496	5	
	WAGON	85 - 86	FLAT	11634	L, N	171	2.0 / 200	--	45	85 - 86	--	--					56496	5	
IMPREZA	HATCHBACK	24 - 24	1.25	11675	AA, HE, ●	133	2.0 / 200	--	30	17 - 24	56367	CWH	4-FLAT		E21	45	56496	5	
	HATCHBACK, SINGLE EXHAUST	17 - 23	1.25	11465	BB, HE	133	2.0 / 200	--	30	12 - 16	56368	CWH	4-FLAT	T44	E22	45	56496	5	
	HATCHBACK, EXCL. WRX AND WRX STI	12 - 16	1.25	11286	BB, HE, ●	129	2.0 / 200	--	30	08 - 12	56111	CWH	4-FLAT	T45	E21	45	56496	5	
	HATCHBACK, WRX AND WRX STI	12 - 14	1.25	11120	AA, D, ●	133	2.0 / 200	--	30	04 - 04	55370	CWH	4-FLAT	T16	E11	10	56496	5	
	HATCHBACK, QUAD EXHAUST	08 - 11	1.25	11120	AA, D, ●	133	2.0 / 200	--	30										
	HATCHBACK, SINGLE EXHAUST	08 - 11	1.25	11315	BB, ●	137	2.0 / 200	--	30										
	SEDAN	17 - 23	1.25	11466	BB, HE, M, ●	145	2.0 / 200	--	35	17 - 23	56212	CWH	4-FLAT		E19	45	56496	5	
	SEDAN, EXCL. WRX AND WRX STI	12 - 16	1.25	11408	BB, V	133	2.0 / 200	--	35	12 - 16	56259	CWH	4-FLAT	T44	E20	45	56496	5	
	SEDAN, WRX AND WRX STI	12 - 14	1.25	11317	BB, HE, ●	155	2.0 / 200	--	30	08 - 15	56061	CWH	4-FLAT		E18	45	56496	5	
	SEDAN	08 - 11	1.25	11317	BB, HE, ●	155	2.0 / 200	--	30	93 - 07	--	--					56496	5	
			93 - 07	1.25	11497	AA, B, N, ●	155	2.0 / 200	--	30									
				1.25	11318	AA, ●	129	2.0 / 200	--	30									
		WAGON	93 - 07	1.25	11497	AA, B, N, ●	155	2.0 / 200	--	30	93 - 07	--	--					56496	5
			1.25	11318	AA, ●	129	2.0 / 200	--	30										
IMPREZA OUTBACK SPORT	CANADIAN BUILT MODELS	10 - 11	1.25	12290	BB, M	145	3.5 / 350	--	45	10 - 11	56040	CWH	4-FLAT		E11	10	56496	5	
	EXCL. CANADIAN BUILT MODELS	08 - 11	1.25	11315	BB, ●	137	2.0 / 200	--	30										
		05 - 07	1.25	11318	AA, ●	129	2.0 / 200	--	30										
			1.25	11318	AA, ●	129	2.0 / 200	--	30										
JUSTY	--	89 - 94	FLAT	11629	D, L, N	147	1.0 / 100	--	40	89 - 94	--	--					56496	5	

CUSTOM WIRING APPLICATION GUIDE FOOTNOTE KEY						For the most up-to-date application information, please visit curtmfg.com					
T1 Multiple parts available. Visit curtmfg.com	T5 Adds 4-flat to factory equipped 7-way	T9 Without factory tow package	T13 Excluding right hand drive	T17 Single rear wheels	T21 Excluding LTZ						
T2 Replaces factory connector with 4-flat	T6 Without LED taillights	T10 Hybrid only	T14 All wheel drive (AWD) models only	T18 SE models only	T22 Excluding plug-in models						
T3 Replaces factory connector with 6-way	T7 With LED taillights	T11 Excluding hybrid	T15 Excluding Grand Touring	T19 Excluding SE models	See page 33 for T23 - T63 footnote key comments						
T4 Replaces factory connector with 7-way	T8 With factory tow package	T12 Excluding EX and Limited	T16 WRX only	T20 Limited 2.0L and EX 2.0L models only	See page 33 for 'Electrical System Notes'						



TRAILER HITCHES

For 1.25" ordering options, see page 32

CUSTOM WIRING

No splicing required

CWH - For vehicles without OE tow package

ADD - Adds to OE tow package

REPL - Replacement for OE tow package

Splice-in Converters

Make / Model	Style / Notes	Years	TRAILER HITCHES							CUSTOM WIRING								
			Rec. Size	Part#	Foot Note	PC	GTW / TW	WD / WDTW	INS	Years	Part#	Prod Type	Plug	FN	PC	INS	Part#	Sys. Note
VOLKSWAGEN																		
ATLAS	--	21 - 24	2	13481	AA, D, ●	45	6.0 / 900	--	45	21 - 24	56464	CWH	4-FLAT	E29	90	56236	10	
		18 - 20	2	13366	AA, ●	49	6.0 / 900	--	30	18 - 20	56383	CWH	4-FLAT	E32	45	56236	10	
ATLAS CROSS SPORT	--	20 - 24	2	13458	AA, ●	78	5.0 / 750	--	30	20 - 24	56464	CWH	4-FLAT	E29	90	56236	10	
BEETLE	CONVERTIBLE, EXCL. ADBLUE TANK	13 - 19	1.25	11354	BB, ●	137	1.5 / 150	--	30	12 - 19	56380	CWH	4-FLAT	T46	E22	45	56496	5
	CONVERTIBLE, EXCL. TURBO	98 - 10	1.25	11066	BB	157	2.0 / 200	--	45	98 - 09	--	--					56496	4
	HATCHBACK, EXCL. DIESEL	12 - 19	1.25	11354	BB, ●	137	1.5 / 150	--	30	12 - 18	56380	CWH	4-FLAT	T46	E22	45	56496	5
	HATCHBACK, EXCL. TURBO	98 - 10	1.25	11066	BB	157	2.0 / 200	--	45	98 - 09	--	--					56496	4
CC	EXCL. 4MOTION	09 - 17	1.25	11091	BB, D, V	159	2.0 / 200	--	60	09 - 17	--	--					56236	10
EOS	--	07 - 16	1.25	11090	AA, V, ●	153	1.0 / 100	--	60	07 - 09	--	--					--	10
EUROVAN	--	93 - 03	2	13217	●	79	4.0 / 400	5.0 / 500	40	93 - 03	--	--					56496	4
GOLF	HATCHBACK	15 - 21	1.25	11412	BB, M, ●	135	2.0 / 200	--	30	10 - 21	--	--					56236	10
		10 - 14	1.25	11000	BB, M, ●	129	2.0 / 200	--	30	91 - 06	--	--					56496	4
	HATCHBACK, 8TH DIGIT OF VIN IS 'J', 4MOTION, EXCL. VR6 AND R32	99 - 06	1.25	11066	BB	157	2.0 / 200	--	45									
	WAGON (CANADA ONLY), EXCL. DIESEL	10 - 14	1.25	11474	BB, M, V, ●	135	2.0 / 200	--	45	10 - 14	--	--					56236	10
GOLF ALLTRACK	--	17 - 19	1.25	11422	AA, D, FR, Q, ●	129	2.0 / 200	--	60	18 - 18	--	--					56236	8
										17 - 17	56391	CWH	4-FLAT	E30	45	56236	8	
GOLF CITY	--	07 - 10	1.25	11066	BB	157	2.0 / 200	--	45	07 - 08	--	--					--	10
GOLF R	--	15 - 19	1.25	11564	AA, FR, Q, ●	147	2.0 / 200	--	90	22 - 24	56527	CWH	4-FLAT	E35	60	56236	8	
										18 - 19	56405	CWH	4-FLAT	E31	45	56236	8	
										15 - 17	56374	CWH	4-FLAT	E28	45	56236		
GOLF SPORTWAGEN	--	15 - 19	1.25	11422	AA, D, FR, Q, ●	129	2.0 / 200	--	60	15 - 19	--	--					56236	10
	TDI, EXCL. TSI	15 - 15	1.25	11411	BB, N, V, ●	149	2.0 / 200	--	50									
GTI	--	15 - 24	1.25	11412	BB, M, ●	135	2.0 / 200	--	30	22 - 24	56527	CWH	4-FLAT	E35	60	56236	8	
		10 - 14	1.25	11000	BB, M, ●	129	2.0 / 200	--	30	18 - 20	56405	CWH	4-FLAT	E31	45	56236	10	
		06 - 09	1.25	11074	BB, M, ●	129	2.0 / 200	--	30	06 - 10	--	--					56236	10
ID.4	WITH FACTORY RECEIVER	21 - 24	2	13489	AA, K, ●	12	3.0 / 300	--	30	21 - 23	--	--					56236	7
	WITHOUT FACTORY RECEIVER	21 - 24	2	13492	AA, FR, Q, ●	49	3.0 / 300	--	90									
JETTA	SEDAN, EXCL. GLI	19 - 24	1.25	11540	B, BB, M, U, ●	157	2.0 / 200	--	35	19 - 24	56523	CWH	4-FLAT	E30	45	56236	10	
	SEDAN, TDI	15 - 15	1.25	11410	AA, ●	159	2.0 / 200	--	45	08 - 18	--	--					56236	10
	SEDAN, EXCL. DIESEL	05 - 18	1.25	11474	BB, M, V, ●	135	2.0 / 200	--	45	80 - 05	--	--					56496	4
	SEDAN, 8TH DIGIT OF VIN IS 'M'	99 - 05	1.25	11070	BB	135	2.0 / 200	--	30									
	WAGON	01 - 05	1.25	11083	AA	167	2.0 / 200	--	40	01 - 05	--	--					56496	4
PASSAT	SEDAN, EXCL. HANDS FREE TRUNK	12 - 22	1.25	11234	AA, V, ●	159	2.0 / 200	--	30	16 - 19	56440	CWH	4-FLAT	E26	45	56236	2	
	SEDAN, NEW BODY, EXCL. 3.6L AWD	06 - 11	1.25	11091	BB, D, V	159	2.0 / 200	--	60	16 - 18	56388	CWH	4-FLAT	N, T6	E24	45	56496	2
	SEDAN, EXCL. 4MOTION	98 - 05	1.25	11054	BB, D	129	2.0 / 200	--	40	12 - 15	56374	CWH	4-FLAT	E28	45	56236	8	
	SEDAN, 4MOTION, EXCL. W8	00 - 05	1.25	11076	BB, N	163	2.0 / 200	--	30	10 - 11	--	--					56496	5
	SEDAN, W8	03 - 04	1.25	11164	AA	178	2.0 / 200	--	30	03 - 09	--	--					56236	10
	WAGON, EXCL. 4MOTION	98 - 05	1.25	11054	BB, D	129	2.0 / 200	--	40	03 - 05	--	--					56496	5
	WAGON, 4MOTION, EXCL. W8	00 - 05	1.25	11076	BB, N	163	2.0 / 200	--	30									
	W8, WAGON	03 - 04	1.25	11164	AA	178	2.0 / 200	--	30									
RABBIT	--	06 - 09	1.25	11074	BB, M, ●	129	2.0 / 200	--	30	06 - 09	--	--					56236	10

CUSTOM WIRING APPLICATION GUIDE FOOTNOTE KEY

For the most up-to-date application information, please visit curtmfg.com

T1 Multiple parts available. Visit curtmfg.com	T5 Adds 4-flat to factory equipped 7-way	T9 Without factory tow package	T13 Excluding right hand drive	T17 Single rear wheels	T21 Excluding LTZ
T2 Replaces factory connector with 4-flat	T6 Without LED taillights	T10 Hybrid only	T14 All wheel drive (AWD) models only	T18 SE models only	T22 Excluding plug-in models
T3 Replaces factory connector with 6-way	T7 With LED taillights	T11 Excluding hybrid	T15 Excluding Grand Touring	T19 Excluding SE models	See page 33 for T23 - T63 footnote key comments
T4 Replaces factory connector with 7-way	T8 With factory tow package	T12 Excluding EX and Limited	T16 WRX only	T20 Limited 2.0L and EX 2.0L models only	See page 33 for 'Electrical System Notes'



TRAILER HITCHES

For 1.25" ordering options, see page 32

CUSTOM WIRING

No splicing required

CWH - For vehicles without OE tow package

ADD - Adds to OE tow package

REPL - Replacement for OE tow package

Splice-in Converters

Make / Model	Style / Notes	Years	TRAILER HITCHES							CUSTOM WIRING						Part#	Sys. Note		
			Rec. Size	Part#	Foot Note	PC	GTW / TW	WD / WDTW	INS	Years	Part#	Prod Type	Plug	FN	PC			INS	
VOLKSWAGEN (CONTINUED)																			
ROUTAN	--	09 - 14	1.25	12264	AA, ●	153	3.5 / 350	--	45	09 - 09	--	--				--	1		
			2	13364	AA, D, ●	16	4.0 / 400	5.0 / 500	30										
TAOS	--	22 - 24	2	13496	AA, D, HE, ●	53	2.0 / 200	--	60	22 - 24	--	--					56236	10	
TIGUAN	--	18 - 24	1.25	12177	AA, ●	145	3.5 / 350	--	30	18 - 24	56403	CWH	4-FLAT	E32	45		56496	2	
			2	13381	AA, ●	35	3.5 / 525	--	30	12 - 17	56422	CWH	4-FLAT	E25	45		56236	10	
		09 - 17	1.25	12097	AA, D, ●	112	3.5 / 350	--	30	09 - 11	--	--						56236	10
			2	13133	AA, D, K, ●	11	3.5 / 350	--	30										
TOUAREG	--	11 - 17	2	13116	AA, FR, Q, ●	51	7.5 / 750	--	75	11 - 17	--	--					56236	10	
		04 - 10	2	13220	A, ●	63	6.0 / 600	--	90	04 - 09	--	--					56496	5	
TRANSPORTER	--	93 - 94	2	13217	●	79	4.0 / 400	5.0 / 500	40	93 - 94	--	--					56496	4	
VOLVO																			
850	--	93 - 97	1.25	12211	AA	137	3.5 / 300	--	30	93 - 97	--	--					56496	5	
C70	--	11 - 13	1.25	11065	AA, N, ●	159	2.0 / 200	--	30	11 - 13	--	--					56236	6	
		COUPE	98 - 02	1.25	12211	AA	137	3.5 / 300	--	30	98 - 02	--	--					56496	5
S40	4TH DIGIT OF VIN IS 'M'	04 - 11	1.25	11438	●	161	2.0 / 200	--	30	08 - 11	--	--					56236	6	
		4TH DIGIT OF VIN IS 'V'	00 - 04	1.25	11822	AA	163	2.5 / 200	--	30	00 - 07	--	--					56496	5
S60	--	11 - 18	1.25	12066	AA, D, FR, Q, ●	175	3.5 / 350	--	90	11 - 20	56224	CWH	4-FLAT	E21	45		56496	5	
			2	13266	AA, D, FR, Q, ●	33	3.5 / 350	--	90	01 - 09	--	--					56496	5	
		01 - 09	1.25	12318	M, ●	145	3.5 / 350	--	30										
S70	--	98 - 00	1.25	12211	AA	137	3.5 / 300	--	30	98 - 00	--	--					56496	5	
S90	--	17 - 21	2	13305	AA, D, ●	69	5.0 / 500	--	60	17 - 24	56285	CWH	4-FLAT	E16	30		56496	5	
V40	--	00 - 04	1.25	11822	AA	163	2.5 / 200	--	30	00 - 04	--	--					56496	5	
V50	--	05 - 11	1.25	11438	●	161	2.0 / 200	--	30	05 - 11	--	--					56496	5	
V60	--	15 - 18	1.25	12066	AA, D, FR, Q, ●	175	3.5 / 350	--	90	15 - 18	56287	CWH	4-FLAT	E20	45		56496	5	
			2	13266	AA, D, FR, Q, ●	33	3.5 / 350	--	90										
V60 CROSS COUNTRY	--	15 - 18	1.25	12066	AA, D, FR, Q, ●	175	3.5 / 350	--	90	15 - 18	56287	CWH	4-FLAT	E20	45		56496	5	
			2	13266	AA, D, FR, Q, ●	33	3.5 / 350	--	90										
V70	--	08 - 10	1.25	12066	AA, D, FR, Q, ●	175	3.5 / 350	--	90	98 - 10	--	--					56496	5	
			2	13266	AA, D, FR, Q, ●	33	3.5 / 350	--	90										
		01 - 07	1.25	12318	M, ●	145	3.5 / 350	--	30										
98 - 00	1.25	12211	AA	137	3.5 / 300	--	30												
XC40	--	19 - 24	2	13611	AA, D, FR, Q, ●	22	4.0 / 600	--	60	21 - 24	56355	CWH	4-FLAT	E21	45		56496	5	
XC40 RECHARGE	--	21 - 24	2	13611	AA, D, FR, Q, ●	22	4.0 / 600	--	60	21 - 24	56355	CWH	4-FLAT	E21	45		56496	5	
XC60	--	18 - 25	2	13484	AA, D, FR, Q, ●	59	4.0 / 400	--	60	10 - 17	56355	CWH	4-FLAT	E21	45		56496	5	
			2	13467	AA, D, FR, Q, ●	37	6.0 / 900	--	65										
		10 - 17	2	13268	AA, V, ●	37	4.0 / 400	4.5 / 450	60										
XC70	--	09 - 16	1.25	12066	AA, D, FR, Q, ●	175	3.5 / 350	--	90	09 - 16	56386	CWH	4-FLAT	E24	45		56496	5	
			2	13266	AA, D, FR, Q, ●	33	3.5 / 350	--	90										03 - 07
		03 - 07	1.25	12318	M, ●	145	3.5 / 350	--	30										
XC90	EXCL. PLUG-IN HYBRID	21 - 25	2	13233	BB, D	55	6.0 / 900	--	45	16 - 24	56285	CWH	4-FLAT	E16	30		56496	5	
	--	16 - 20	2	13233	BB, D	55	6.0 / 900	--	45	05 - 14	56045	CWH	4-FLAT	E16	20		56496	5	
		18 - 20	2	13467	AA, D, FR, Q, ●	37	6.0 / 900	--	65										
	03 - 14	2	13559	AA, D, ●	49	3.5 / 350	5.0 / 500	30											

TRAILER HITCH APPLICATION GUIDE FOOTNOTE KEY

For the most up-to-date application information, please visit curtmfg.com

A Allow additional installation time	CC Roll pan mods required	F Will not fit vehicles with ground effects	HE Hole enlargement required	L Fixed draw bar	Q Temporary bumper removal	TG Compatible with Tommy Gate lifts	VT Vertical receiver tube
AA Main body concealed	CF Carbide black finish	FR Temporary bumper fascia removal	I Will not fit with full size spare	M Round tube main body	R Boxed due to bolt-on arms	U May require battery removal	W Only with boxed rear bumper
B Relocate or modify exhaust	D Minor fascia trim required	G Add'l install w/ load level air compressors	J No spare tire relocation	N Continued while supplies last	S May interfere hands free liftgate sensor	V Under-car trim (not fascia) req'd	● No drilling required
BB Main body exposed	E Noticeable fascia trim required	H Will not fit vehicles with twin tailpipes	K OEM-style hitch	P Not with roll pan bumper	T Modifications required (minor)	X 158" WB models require brace removal, 118" WB models require spare tire reloc.	



TRAILER HITCHES

For 1.25" ordering options, see page 32

CUSTOM WIRING

No splicing required

CWH - For vehicles without OE tow package

ADD - Adds to OE tow package

REPL - Replacement for OE tow package

Splice-in Converters

Make / Model	Style / Notes	Years	Rec. Size	Part#	Foot Note	PC	GTW / TW	WD / WDTW	INS	Years	Part#	Prod Type	Plug	FN	PC	INS	Part#	Sys. Note
--------------	---------------	-------	-----------	-------	-----------	----	----------	-----------	-----	-------	-------	-----------	------	----	----	-----	-------	-----------

NOTES & ADDITIONS

CUSTOM WIRING APPLICATION GUIDE FOOTNOTE KEY For the most up-to-date application information, please visit curtmfg.com

T1 Multiple parts available. Visit curtmfg.com	T5 Adds 4-flat to factory equipped 7-way	T9 Without factory tow package	T13 Excluding right hand drive	T17 Single rear wheels	T21 Excluding LTZ
T2 Replaces factory connector with 4-flat	T6 Without LED taillights	T10 Hybrid only	T14 All wheel drive (AWD) models only	T18 SE models only	T22 Excluding plug-in models
T3 Replaces factory connector with 6-way	T7 With LED taillights	T11 Excluding hybrid	T15 Excluding Grand Touring	T19 Excluding SE models	See page 33 for T23 - T63 footnote key comments
T4 Replaces factory connector with 7-way	T8 With factory tow package	T12 Excluding EX and Limited	T16 WRX only	T20 Limited 2.0L and EX 2.0L models only	See page 33 for 'Electrical System Notes'



TOWING ACCESSORIES

FEATURED PRODUCTS



NEW

AlumaLite™ ball mounts

CURT AlumaLite™ adjustable aluminum hitches combine strength and weight savings for easier towing and leveling of trailers.



NEW

Hitch & coupler locks

Hitch and coupler locks protect your trailer from theft, giving you the peace of mind you need whether you're at the lake or campground.



NEW

Anti-rattle hitch clamp

Quick and easy to install, CURT anti-rattle hitch clamps ensure a quieter ride when towing your trailer.

PRODUCT INDEX



86
Trailer
Balls



93
Ball
Mounts



98
Towing
Starter Kits



101
Forged
Ball Mounts



104
Adjustable
Ball Mounts



111
Tow Hook
Mounts



112
Extenders
& Adapters



115
Hitch Locks,
Pins & Clips



120
Specialty Locks
& Anti-Rattles



127
Pintle Hooks
& Mounts



132
Trailer Hitch
Accessories



138
Repl. Parts
& Fabrication

TRAILER BALLS



ROCKERBALL™ TRAILER BALLS

- Dampens jerking and jarring from bumps and potholes for smoother towing
- Cushioned isolators reduce rattling and vibration for a more comfortable ride
- Reduces shock loads to the vehicle during sudden braking or acceleration
- Minimizes stress on tow vehicle's brakes and suspension for extended longevity
- Virtually maintenance-free with no airbag or bearings to service
- Anti-swivel base keeps RockerBall locked in place
- Forged steel construction with a durable carbide black powder coat finish on base and chrome plating on ball
- Tested for safety to meet SAE J684 specifications
- Not compatible with Rebellion™ XD ball mount
- **See page 138 for replacement parts**



Scan to learn more

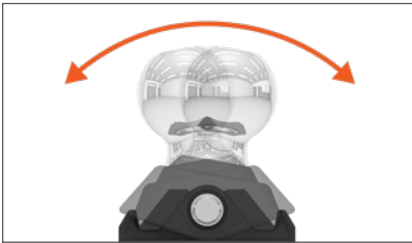

Dynamic trailer balls featuring ShockDrop™ technology reduce jerking and jarring



Retrofits onto most existing ball mounts to improve current towing experience



Grease zerk fitting allows for easy, periodic application of lubricant



Shank Diameter (C)	Shank Length (B)	Rise (D)	Tongue Width (E)	GTW	Pkg Box #	Pkg Throne #
2" Ball Diameter (A)						
3/4"	2-1/8"	1-1/2"	2"	3,500 lbs.	--	40246
1"	2-1/8"	1-1/2"	2-1/2"	7,500 lbs.	40047	40247
2-5/16" Ball Diameter (A)						
1"	2-1/2"	1-5/8"	2-1/2"	7,500 lbs.	--	40248
1-1/4"	2-7/8"	1-5/8"	3"	12,000 lbs.	--	40249

Measuring RockerBall

- A: Ball diameter
- B: Shank length
- C: Shank diameter
- D: Rise
- E: Tongue width

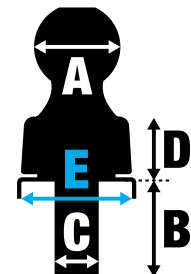



COMFORT. CONTROL. CONFIDENCE.



For Rebellion™ XD cushion hitches see page 102

ShockDrop technology is an adaptive, dynamic towing system that is engineered to reduce vibrations, rattling and strain on the vehicle. It does this by using an integrated, flexible polyurethane isolator for improved comfort and control. Compared to other cushion hitch options, ShockDrop is simple and virtually maintenance-free.

Enhanced comfort.

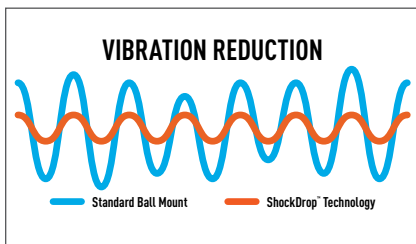

Unlike a traditional metal-on-metal towing connection, ShockDrop absorbs unevenness in the road to maximize comfort

Improved control.

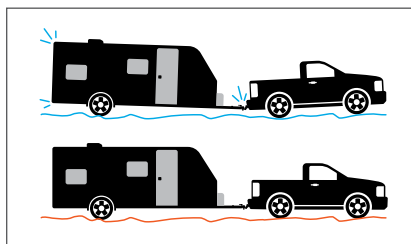

ShockDrop dynamically reacts to jarring, limiting its effects and giving the driver increased control on the road

Low maintenance.

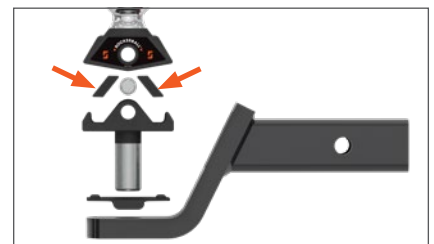

Unlike a cushion hitch with an airbag or bearings, ShockDrop is virtually maintenance-free and is tested for thousands of cycles



- Includes all the accessories needed to complement a trailer hitch in one kit (excluding #45149)



45144



45143



45149

Part #	Shank Size	GTW / TW	Ball Diameter	Drop	Length	Included Parts
45143	2"	7,500 / 750 lbs.	2"	3"	8-1/4"	45050 ball mount, 40047 RockerBall, 22323 anti-rattle pin
45144	2"	7,500 / 750 lbs.	2"	5"	9-1/4"	45070 ball mount, 40047 RockerBall, 22323 anti-rattle pin
45149	2"	7,500 / 750 lbs.	2-5/16"	1"	7-1/2"	45820 sway tab ball mount, 40248 RockerBall

STANDARD TRAILER BALLS

For master and inner pack quantities see page 349

- Fine threads provide superior holding strength
- Tested for safety to meet U.S. VESC V-5 specifications

• See page 138 for replacement parts

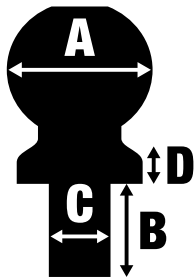

Measuring a trailer ball

- A: Ball diameter
- B: Shank length
- C: Shank diameter
- D: Rise

Chrome-plated



Stainless steel



Raw



Shank Diameter (C)	Shank Length (B)	Rise (D)	GTW	Chrome Bulk #	Chrome Full Throne #	Chrome Half Throne #	Stainless Bulk #	Stainless Full Throne #	Raw Bulk #
1-7/8" Ball Diameter (A)									
3/4"	1-5/8"	0"	2,000 lbs.	40001	40061	40161	--	--	--
3/4"	2-1/8"	0"	2,000 lbs.	40015	40063	40163 N	40050*	40080	--
3/4"	3"	0"	2,000 lbs.	40016	40071	40171 N	--	--	--
1"	2-1/8"	0"	3,500 lbs.	40002	40062	40162	40051*	40081	--
1"	2-1/8"	2"	3,500 lbs.	40032	--	--	--	--	--
1"	3"	0"	3,500 lbs.	40017	40072	40172 N	--	--	--
2" Ball Diameter (A)									
3/4"	1-3/4"	0"	3,500 lbs.	40003	40064	40164	--	--	--
3/4"	2-1/8"	0"	3,500 lbs.	40018	40065	40165 N	40052	40082	--
3/4"	3"	0"	3,500 lbs.	40019	40073	40173 N	--	--	--
1"	2-1/8"	0"	6,000 lbs.	40004	40066	40166	40053	40083	--
1"	2-1/8"	0"	7,500 lbs.	40037	40070	40170	--	--	--
1"	2-1/8"	1"	6,000 lbs.	40033	--	--	--	--	--
1"	2-1/8"	2"	6,000 lbs.	40034	--	--	--	--	--
1"	2-1/4"	0"	12,000 lbs.	40038†	--	--	--	--	--
1"	3"	0"	6,000 lbs.	40020	40074	40174 N	--	--	--
1-1/4"	2-5/8"	0"	10,000 lbs.	40090	40069	40190	40056	--	--
2-5/16" Ball Diameter (A)									
1"	2-1/8"	0"	7,500 lbs.	40005	40067	40167	--	40084	--
1"	2-1/4"	0"	10,000 lbs.	40007	--	--	--	--	--
1"	2-1/4"	0"	12,000 lbs.	40039†	--	--	--	--	40042†
1"	3"	0"	6,000 lbs.	40021	40075	40175 N	--	--	--
1-1/4"	2-5/8"	0"	10,000 lbs.	40006	40068	40168	--	--	--
1-1/4"	2-5/8"	0"	15,000 lbs.	40030†	40078†	40178†	40055	--	--
1-1/4"	2-5/8"	0"	30,000 lbs.	--	--	--	--	--	40085†
1-1/4"	2-5/8"	1"	10,000 lbs.	40035	--	--	--	--	--
1-1/4"	2-5/8"	1"	25,000 lbs.	--	--	--	--	--	40086†
1-1/4"	2-5/8"	2"	10,000 lbs.	40036	--	--	--	--	--
1-1/4"	2-5/8"	2"	25,000 lbs.	--	--	--	--	--	40087†
1-1/4"	2-3/4"	0"	20,000 lbs.	40008†	40009†	40109† N	--	--	--
1-1/4"	3"	0"	6,000 lbs.	40022	40076	40176 N	--	--	--
2"	3-1/2"	0"	30,000 lbs.	--	--	--	--	--	40088†
3" Ball Diameter (A)									
2"	3-1/4"	0"	30,000 lbs.	--	--	--	--	--	40089†
50mm Ball Diameter (A)									
3/4"	50mm	0"	1,600 kg.	40099	--	--	--	--	--

† Heat-treated ‡ Heat-treated, coarse-threaded

* Continued while supplies last

ATV-LAWN TRACTOR TRAILER BALLS

- Fits ATVs, UTVs or lawn tractors with 5/8" ball hole
- Constructed from high-strength, hot-forged steel
- Enhanced durability with chrome-plated finish
- Fine threading for superior holding strength
- Tested for safety to meet U.S. VESC V-5 specifications
- **See page 138 for replacement parts**



Ball Diameter	Shank Diameter	Shank Length	Rise	GTW	Torque Specification	Bulk #	Chrome Full Throne #	Chrome Half Throne #
1-7/8"	5/8"	1-3/4"	0"	2,000 lbs.	90 lb-ft.	40095	40096	40196 N
2"	5/8"	1-3/4"	0"	2,000 lbs.	90 lb-ft.	40097	40098	40198 N

TRAILER BALL COVERS

- Protects trailer ball when not in use

Bulk #	Pkg #	Material	Fits
21800	21801	Black rubber	1-7/8" and 2" trailer balls
21810	21811	Black rubber	2-5/16" trailer balls



TRAILER BALL BOX-END WRENCH

- Six-point design ensures the best grip and protects against rounding of the nut
- Forged, hardened steel construction with a durable chrome plating



Part #	Length	Wrench Sizes	Fits
20001	15-1/2"	1-1/8" and 1-1/2"	3/4" and 1" shanks

Six-point design protects from rounding the nut on the trailer ball



THOROUGHLY TESTED FOR SAFETY

REDUCER BUSHINGS

- Reduces hole size, allowing use of trailer balls with smaller shank diameters



Bulk #	Pkg #	Reduces From	Reduces To	Finish
21100	21101	1"	3/4"	Yellow zinc-plated
21200	21201	1-1/4"	1"	Yellow zinc-plated
21300	--	1-3/8"	1-1/4"	Yellow zinc-plated



Reduces the hole of your ball mount to fit smaller trailer balls

BALL MOUNT TONGUE SLEEVE

- Allows for single-wrench trailer ball torquing
- For use with CURT and other 'wrench flat' trailer balls
- See our trailer ball box-end wrench on page 89
- Patent #8,376,387



Tighten your trailer ball with a single wrench

Part #	Fits	Ball Hole Size	Finish
45007*	2-1/2" tongue width	1"	Gloss black

* Continued while supplies last

SWITCH BALL™ TRAILER BALLS

- Exclusive 'J' groove design for secure attachment to the shank
- No tools, coins or pins required for trailer ball install or removal
- Shank bears the weight, freeing the coupler from binding
- Built from high-strength steel
- Protected by a premium grade, nickel chrome-plated finish
- Neck covers protect the Switch Ball neck from the elements when not in use
- Tested for safety in accordance with SAE J684
- U.S. patent #5,169,168; Canadian patent #1,325,445
- **See page 138 for replacement parts**

Features

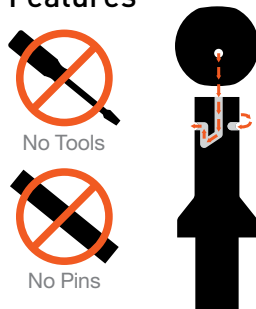

Measuring a Switch Ball

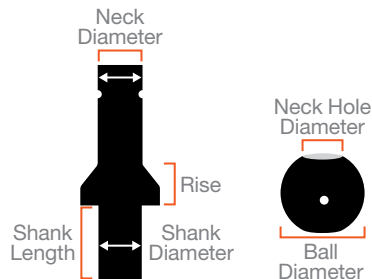

Place the ball on the shank



Twist the ball down onto the shank to lock



42178



42280



42225



41352



41353



Part #	Ball Diameter and GTW			Shank Length	Shank Diameter	Neck Diameter	Rise	Finish
	1-7/8"	2"	2-5/16"					
Switch Ball™ Trailer Ball Sets								
42178*	3,500 lbs.	6,000 lbs.	--	2-1/4"	1"	1"	0"	Chrome-plated
42225	3,500 lbs.	6,000 lbs.	8,000 lbs.	2-1/4"	1"	1-1/8"	3/4"	Chrome-plated
42280*	--	6,000 lbs.	8,000 lbs.	2-1/4"	1"	1-1/8"	3/4"	Chrome-plated
41782*	3,500 lbs.	6,000 lbs.	--	1-5/8"	3/4"	1"	0"	Chrome-plated
Switch Ball™ Neck Covers								
41352*	--	--	--	--	--	1"	--	Black rubber
41353*	--	--	--	--	--	1"	--	Red rubber

* Continued while supplies last



Rebellion™ XD 2-1/2" shank with dual-ball



ENGINEERED WITH A SLEEK, MODERN LOOK

BALL MOUNTS

1 1/4 INCH EURO MOUNT® BALL MOUNTS

- Fits any 1-1/4" receiver tube opening
- Installs easily with no tools or torque specifications required
- Permanently attached trailer ball cannot be loosened or stolen
- Durable carbide black powder coat finish
- Patents: #D610,051 S; #D610,492 S; #D610,493 S; #D610,494 S; #D610,954 S



45551 (1-7/8" ball)
45552 (2" ball)



45571 (1-7/8" ball)
45572 (2" ball)



45561 (1-7/8" ball)
45562 (2" ball)



45591 (1-7/8" ball)
45592 (2" ball)

Part #	GTW / TW	Ball Diam.	Ball Height	Length
45551*	3,500 / 350 lbs.	1-7/8"	2-3/4"	10"
45571*	3,500 / 350 lbs.	1-7/8"	4-5/8"	7-1/4"
45561*	3,500 / 350 lbs.	1-7/8"	5-1/8"	9-3/4"
45591*	3,500 / 350 lbs.	1-7/8"	5-1/8"	11-1/4"
45552*	3,500 / 350 lbs.	2"	2-3/4"	10"
45572*	3,500 / 350 lbs.	2"	4-5/8"	7-1/4"
45562*	3,500 / 350 lbs.	2"	5-1/8"	9-3/4"
45592*	3,500 / 350 lbs.	2"	5-1/8"	11-1/4"

* Continued while supplies last

Required Ball Height = A - B

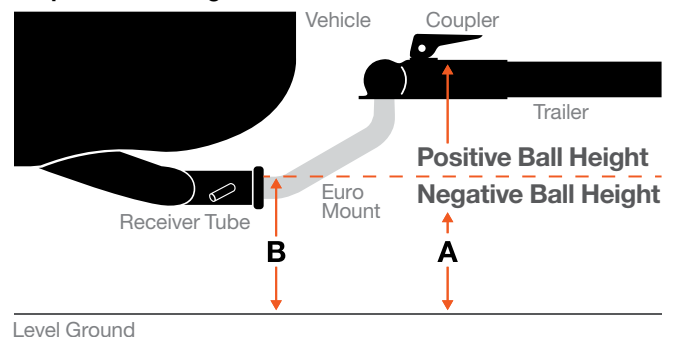

MEASURING A BALL MOUNT

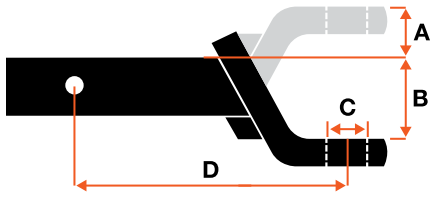

A: Rise

Distance the ball platform is set above the top of the shank.

B: Drop

Distance the ball platform is set below the top of the shank.

C: Hole Size

Size of trailer ball shank that is required to fit the ball mount.

D: Length

Distance from the pin hole center to the ball hole center.

1 1/4
INCH

CLASS 1 & 2 BALL MOUNTS

- Fits any 1-1/4" x 1-1/4" receiver tube opening
- Multiple drop and rise options to accommodate various vehicle-trailer combinations
- Compatible with anti-rattle accessory to help stop vibration (see page 125)



Multiple drop and rise options accommodate various vehicle-trailer combinations



Part #	GTW / TW	Drop	Rise	Length	Tongue Hole Size	Shank Type	Finish
Class 1 Ball Mounts							
45018	2,000 / 200 lbs.	1-1/4"	5/8"	6-3/4"	3/4"	Hollow	Gloss black
45019	2,000 / 200 lbs.	1-1/4"	5/8"	9-3/4"	3/4"	Hollow	Gloss black
45027	2,000 / 200 lbs.	3-1/4"	2-5/8"	6-1/4"	3/4"	Hollow	Gloss black
45022	2,000 / 200 lbs.	3-1/4"	2-5/8"	7-1/4"	3/4"	Hollow	Gloss black
45026	2,000 / 200 lbs.	3-1/4"	2-5/8"	9-3/8"	3/4"	Hollow	Gloss black
45028	2,000 / 200 lbs.	6"	4-5/8"	5-9/16"	3/4"	Solid	Gloss black
45021	2,000 / 200 lbs.	--	3-3/4"	9-1/2"	3/4"	Solid	Gloss black
45023	2,000 / 200 lbs.	--	3-3/4"	11-1/2"	3/4"	Solid	Gloss black
45024	2,000 / 200 lbs.	--	5"	9-9/16"	3/4"	Solid	Gloss black
45025	2,000 / 200 lbs.	--	5"	11-9/16"	3/4"	Solid	Gloss black
Class 2 Ball Mounts							
45503	3,500 / 350 lbs.	1"	3/8"	7-13/16"	3/4"	Solid	Gloss black
45518	3,500 / 350 lbs.	1-1/4"	3/4"	6-3/4"	3/4"	Solid	Gloss black
45519	3,500 / 350 lbs.	1-1/4"	3/4"	9-3/4"	3/4"	Solid	Gloss black
45017	3,500 / 350 lbs.	3-1/4"	2-5/8"	6-1/4"	3/4"	Solid	Gloss black
45521	3,500 / 350 lbs.	3-1/4"	2-5/8"	7-1/4"	3/4"	Solid	Gloss black
45016	3,500 / 350 lbs.	3-1/4"	2-5/8"	9-3/8"	3/4"	Solid	Gloss black
45520	3,500 / 350 lbs.	--	3-1/8"	9-3/4"	3/4"	Solid	Gloss black
45510	3,500 / 350 lbs.	--	3-1/8"	10-5/16"	3/4"	Solid	Gloss black
45522	3,500 / 350 lbs.	--	3-1/8"	11-1/4"	3/4"	Solid	Gloss black
45000	3,500 / 350 lbs.	--	3-7/8"	13-1/2"	3/4"	Solid	Gloss black
45014	3,500 / 350 lbs.	--	5"	9-5/8"	3/4"	Solid	Gloss black
45015	3,500 / 350 lbs.	--	5"	11-5/8"	3/4"	Solid	Gloss black



2 CLASS 3 BALL MOUNTS

INCH

- Fits any 2" x 2" receiver tube opening
- Multiple drop and rise options to accommodate various vehicle-trailer combinations
- Increased drop on select models allows for level towing with lifted vehicles
- Compatible with anti-rattle accessory to help stop vibration (see page 125)
- White box kits include a pin & clip



USA Made #	Imported Bulk #	Chrome Bulk #	White Box Kit #	GTW / TW	Drop	Rise	Length	Tongue Hole Size	Shank Type
45030	45830	45290	45032	7,500 / 750 lbs.	2"	3/4"	7-1/2"	1"	Hollow
45010	45828	--	45012	7,500 / 750 lbs.	2"	3/4"	8-1/4"	1"	Hollow
45040	45840	--	--	7,500 / 750 lbs.	2"	3/4"	10-1/4"	1"	Hollow
45020	45829	--	--	7,500 / 750 lbs.	2"	3/4"	10-1/4"	1"	Hollow
45260	--	--	--	7,500 / 750 lbs.	2"	3/4"	12-1/4"	1"	Hollow
45250	--	--	--	7,500 / 750 lbs.	2"	3/4"	12-1/4"	1"	Hollow
45050	45850	45296	45052	7,500 / 750 lbs.	4"	2"	8-1/4"	1"	Hollow
45060	45860	--	--	7,500 / 750 lbs.	4"	2"	10-1/4"	1"	Hollow
45270	--	--	--	7,500 / 750 lbs.	4"	2"	13"	1"	Hollow
45070	45870	45297	--	7,500 / 750 lbs. drop 6,000 / 600 lbs. rise	6"	4"	9-1/4"	1"	Hollow
45080	45880	--	--	7,500 / 750 lbs. drop 6,000 / 600 lbs. rise	6"	4"	12-1/4"	1"	Hollow
45280	--	--	--	7,500 / 750 lbs. drop 6,000 / 600 lbs. rise	6"	4"	14-1/4"	1"	Hollow
45090	45890	--	--	5,000 / 500 lbs. drop 3,500 / 350 lbs. rise	8"	6"	11-1/2"	1"	Hollow
45100	45891	--	--	5,000 / 500 lbs. drop 3,500 / 350 lbs. rise	8"	6"	13"	1"	Hollow
45110	45892	--	--	5,000 / 500 lbs. drop 3,500 / 350 lbs. rise	10"	8"	13"	1"	Hollow
45112	45893	--	--	5,000 / 500 lbs. drop 3,500 / 350 lbs. rise	10"	8"	14"	1"	Hollow



LIGHTWEIGHT AND CORROSION-RESISTANT

2

INCH

ALUMINUM BALL MOUNTS

- Fits trailer hitches with a 2" x 2" receiver tube opening
- Constructed from solid aluminum to be lightweight and naturally rust-resistant
- Tested for safety in accordance with SAE J684
- Compatible with anti-rattle accessory to help stop vibration (see page 125)



Constructed from solid aluminum to be lightweight and naturally rust-resistant

Part #	GTW / TW	Drop	Rise	Length	Tongue Hole Size	Shank Type	Finish
45360	8,000 / 800 lbs.	2"	1"	8-1/2"	1"	Solid	Matte
45361	8,000 / 800 lbs.	4"	3"	8-1/2"	1"	Solid	Matte
45362	8,000 / 800 lbs.	6"	5"	8-1/2"	1"	Solid	Matte

1 1/4" & 2" & 2 1/2" & 3" LOADED BALL MOUNTS

- Includes a factory-torqued trailer ball (pin & clip included on select models)
- Three-packs include a point-of-purchase tray
- Compatible with anti-rattle accessory to help stop vibration (see page 125)



USA Made #	Imported Part #	Box #	Three-Pack #	GTW / TW	Ball Diameter	Drop	Length	Shank Type	Finish
1-1/4" x 1-1/4" Loaded Ball Mounts									
45148†	--	--	--	3,500 / 350 lbs.	2"	3-1/4"	7-1/4"	Solid	Gloss black
45147†	--	--	--	3,500 / 350 lbs.	2"	1-1/4"	9-3/4"	Solid	Gloss black
2" x 2" Loaded Ball Mounts									
45034†	45834†	--	--	3,500 / 350 lbs.	1-7/8" (40002)	2"	8-1/4"	Hollow	Gloss black
--	--	45293†	--	3,500 / 350 lbs.	1-7/8" (40002)	2"	8-1/4"	Hollow	Chrome-plated
45036†	45836†	--	45037†	7,500 / 750 lbs.	2" (40037)	2"	8-1/4"	Hollow	Gloss black
--	--	45295†	--	7,500 / 750 lbs.	2" (40037)	2"	8-1/4"	Hollow	Chrome-plated
45041†	--	--	--	7,500 / 750 lbs.	2-5/16" (40005)	2"	8-1/4"	Hollow	Gloss black
45055†	45855†	--	--	3,500 / 350 lbs.	1-7/8" (40002)	4"	8-1/4"	Hollow	Gloss black
45056†	45856†	--	45057†	7,500 / 750 lbs.	2" (40037)	4"	8-1/4"	Hollow	Gloss black
45042†	--	--	--	7,500 / 750 lbs.	2-5/16" (40005)	4"	8-1/4"	Hollow	Gloss black
45064†	--	--	--	7,500 / 750 lbs.	2" (40037)	6"	9-1/4"	Hollow	Gloss black
45065†	--	--	--	7,500 / 750 lbs.	2-5/16" (40005)	6"	9-1/4"	Hollow	Gloss black
2" x 2" Loaded Ball Mounts - Forged									
--	45331	--	--	15,000 / 1,500 lbs.	2-5/16" (40030)	2"	8-1/2"	Solid	Carbide black
--	45332	--	--	15,000 / 1,500 lbs.	2-5/16" (40030)	4"	8-1/2"	Solid	Carbide black
--	45370	--	--	15,000 / 1,500 lbs.	2-5/16" (40030)	6"	9-1/2"	Solid	Carbide black
2-1/2" x 2-1/2" Loaded Ball Mounts - Forged									
--	45371	--	--	20,000 / 2,000 lbs.	2-5/16" (40008)	2"	8-1/2"	Solid	Carbide black
--	45372	--	--	20,000 / 2,000 lbs.	2-5/16" (40008)	4"	8-1/2"	Solid	Carbide black
--	45373	--	--	20,000 / 2,000 lbs.	2-5/16" (40008)	6"	9"	Solid	Carbide black
--	45374	--	--	20,000 / 2,000 lbs.	2-5/16" (40008)	8"	10"	Solid	Carbide black
3" x 3" Loaded Ball Mounts - Forged									
--	45375	--	--	20,000 / 2,000 lbs.	2-5/16" (40008)	4"	9"	Solid	Carbide black
--	45376	--	--	20,000 / 2,000 lbs.	2-5/16" (40008)	6"	10"	Solid	Carbide black
--	45377	--	--	20,000 / 2,000 lbs.	2-5/16" (40008)	8"	10-1/2"	Solid	Carbide black

† Includes pin & clip

‡ Ball mount made in USA with imported trailer ball, pin & clip



COMFORT. CONTROL. CONFIDENCE.

2 TOWING STARTER KITS

Scan to learn more



RockerBall™ starter kits

- Dynamic trailer ball and ball mount kit featuring ShockDrop™ technology
- Dampens jerking and jarring from bumps and potholes for smoother towing
- Includes anti-rattle kit to help stop rattling and vibration
- For more details on the advantages of RockerBall, see page 86

Standard starter kits

- Includes all the accessories needed to complement a trailer hitch in one kit
- Reusable case is able to be shelved or hung on pegs (#45534, #45554)
- Compatible with anti-rattle accessory to help stop vibration (see page 125)



45144



45143



45534



45554



Part #	Shank Size	GTW / TW	Ball Diameter	Drop	Length	Included Parts
RockerBall Starter Kits						
45143	2"	7,500 / 750 lbs.	2"	3"	8-1/4"	45050 ball mount, 40047 RockerBall, 22321 anti-rattle
45144	2"	7,500 / 750 lbs.	2"	5"	9-1/4"	45070 ball mount, 40047 RockerBall, 22321 anti-rattle
Standard Starter Kits						
45534*	2"	7,500 / 750 lbs.	2"	2"	8-1/4"	45030 ball mount, 40037 trailer ball, 23515 hitch lock, 22272 hitch tube cover, 21500 pin & clip, case
45554*	2"	7,500 / 750 lbs.	2"	4"	8-1/4"	45050 ball mount, 40037 trailer ball, 23515 hitch lock, 22272 hitch tube cover, 21500 pin & clip, case

* Includes sturdy, reusable case

**2**

INCH

RV TOWING STARTER KIT

- Complete kit to maximize comfort and control when towing a small travel trailer
- Ideal for vehicles less than 5,000 lbs. GVW and trailers 3,500 to 5,000 lbs. GTW
- Pre-torqued RockerBall™ dampens jerking and jarring for smoother towing, [see page 87 for more information](#)
- Echo® brake controller uses Bluetooth and smartphone to control trailer brakes, [see page 144 for more information](#)
- Sway control unit helps limit lateral trailer movement to reduce sway



45190

Part #	Shank Size	GTW / TW	Ball Diameter	Drop	Length	Included Parts
45190	2"	7,500 / 750 lbs.	2-5/16"	1"	7-1/2"	45149 RockerBall pre-torqued on sway tab mount, 51180 Echo brake controller, 17200 sway control, 22323 anti-rattle

**2**

INCH

ROCKERBALL™ CUSHION HITCH WITH SWAY TAB

- Dynamic trailer ball and ball mount kit featuring ShockDrop™ technology
- Pre-torqued RockerBall™ dampens jerking and jarring for smoother towing, [see page 87 for more information](#)
- Reduces shock loads to the vehicle during sudden braking or acceleration
- Sway tab provides an attachment point for a trailer sway control unit
- [See page 197 for sway control accessories](#)



45149

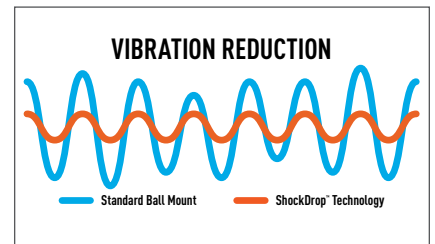

Unlike a traditional metal-on-metal towing connection, ShockDrop absorbs unevenness in the road to maximize comfort

Part #	Shank Size	GTW / TW	Ball Diameter	Drop	Length
45149	2"	7,500 / 750 lbs.	2-5/16"	1"	7-1/2"

2

INCH

SWAY TAB BALL MOUNT

- Fits any 2" x 2" receiver tube opening
- Provides a mounting tab for a sway control trailer ball (ball sold separately)
- Compatible with anti-rattle accessory
- [See page 197 for sway control accessories](#)



45820



Coupled sway control (17200)

Part #	GTW / TW	Drop	Rise	Length	Tongue Hole Size
45820	7,500 / 750 lbs.	2"	3/4"	7-1/2"	1"

2

INCH

FUSION™ BALL MOUNTS

- Fits any 2" x 2" receiver tube opening
- Welded trailer ball cannot be loosened or stolen
- Compatible with anti-rattle accessory (see page 125)



45141 (2" ball) -
includes hitch lock



45131 (1-7/8" ball)
45134 (2" ball)



45142 (2" ball) -
includes hitch lock



45151 (1-7/8" ball)
45154 (2" ball)



45152 (1-7/8" ball)
45155 (2" ball)

Part #	GTW / TW	Ball Diameter	Drop	Rise	Length	Finish	Includes
45131	5,000 / 500 lbs.	1-7/8"	2"	--	7-1/2"	Gloss black	Pin & clip
45134	7,500 / 750 lbs.	2"	2"	--	7-1/2"	Gloss black	Pin & clip
45141	7,500 / 750 lbs.	2"	2"	--	7-1/2"	Gloss black	Hitch lock
45151	5,000 / 500 lbs.	1-7/8"	4"	--	8-1/8"	Gloss black	Pin & clip
45154	7,500 / 750 lbs.	2"	4"	--	8-1/8"	Gloss black	Pin & clip
45142	7,500 / 750 lbs.	2"	4"	--	8-1/8"	Gloss black	Hitch lock
45152	5,000 / 500 lbs.	1-7/8"	--	2"	8-1/8"	Gloss black	Pin & clip
45155	7,500 / 750 lbs.	2"	--	2"	8-1/8"	Gloss black	Pin & clip

2

INCH

CLASS 4 BALL MOUNTS

- Fits any 2" x 2" receiver tube opening
- Increased drop allows for level towing with lifted vehicles
- Compatible with anti-rattle accessory (see page 125)



45310



45312



45311



45313



45336



45446



45338



45448

Part #	GTW / TW	Drop	Rise	Length	Tongue Hole Size	Shank Type	Finish
45310	10,000 / 1,000 lbs.	2"	1"	9-3/8"	1-1/4"	Hollow	Gloss black
45311	10,000 / 1,000 lbs.	4"	2-3/4"	9-3/8"	1-1/4"	Hollow	Gloss black
45336	10,000 / 1,000 lbs.	6"	4-3/4"	9-3/8"	1-1/4"	Hollow	Gloss black
45338	10,000 / 1,000 lbs.	8"	6-3/4"	9-3/8"	1-1/4"	Hollow	Gloss black
45312	12,000 / 1,200 lbs.	2"	1"	9-3/8"	1-1/4"	Solid	Gloss black
45313	12,000 / 1,200 lbs.	4"	3"	9-3/8"	1-1/4"	Solid	Gloss black
45446	12,000 / 1,200 lbs.	6"	5"	9-3/8"	1-1/4"	Solid	Gloss black
45448	12,000 / 1,200 lbs.	8"	7"	9-3/8"	1-1/4"	Solid	Gloss black

2 INCH DUAL-LENGTH BALL MOUNTS

- Fits any 2" x 2" receiver tube opening
- Two hitch pin holes for varying length
- Compatible with anti-rattle accessory to help stop vibration (see page 125)



45220



45230



45240

Part #	GTW / TW	Drop	Rise	Length	Hole	Finish
45220	7,500 / 750 lbs.	2"	3/4"	7-1/2" or 10-1/2"	1"	Gloss black
45230	7,500 / 750 lbs.	4"	2"	8-1/8" or 11-1/8"	1"	Gloss black
45240	7,500 / 750 lbs. drop 6,000 / 600 lbs. rise	6"	4"	9-1/4" or 12-1/4"	1"	Gloss black



Two pin holes for varying length

2 INCH & 2 1/2 INCH & 3 INCH FORGED BALL MOUNTS

- Solid, forged steel for superior strength
- Compatible with anti-rattle accessory (see page 125)
- Also available with pre-torqued trailer ball (see page 97)



45340



45341



45342



45456



45458



45459



45460



45430



45431



45432

Part #	Shank Size	GTW / TW	Drop	Rise	Length	Tongue Hole Size	Finish
2" x 2" Xtra Duty Forged Ball Mounts							
45340	2" x 2"	17,000 / 2,550 lbs.	2"	1"	8-1/2"	1-1/4"	Carbide black
45341	2" x 2"	17,000 / 2,550 lbs.	4"	3"	8-1/2"	1-1/4"	Carbide black
45342	2" x 2"	17,000 / 2,550 lbs.	6"	5"	9-1/2"	1-1/4"	Carbide black
2-1/2" x 2-1/2" Commercial Duty Forged Ball Mounts							
45456	2-1/2" x 2-1/2"	20,000 / 2,700 lbs.	2"	1/2"	8-1/2"	1-1/4"	Carbide black
45458	2-1/2" x 2-1/2"	20,000 / 2,700 lbs.	4"	2-1/2"	8-1/2"	1-1/4"	Carbide black
45459	2-1/2" x 2-1/2"	20,000 / 2,700 lbs.	6"	4-1/2"	9"	1-1/4"	Carbide black
45460	2-1/2" x 2-1/2"	20,000 / 2,700 lbs. drop 16,000 / 2,160 lbs. rise	8"	6-1/2"	10"	1-1/4"	Carbide black
3" x 3" Industrial Duty Forged Ball Mounts							
45430	3" x 3"	21,000 / 2,800 lbs.	4"	2"	9"	1-1/4"	Carbide black
45431	3" x 3"	21,000 / 2,800 lbs.	6"	4"	10"	1-1/4"	Carbide black
45432	3" x 3"	21,000 / 2,800 lbs.	8"	6"	10-1/2"	1-1/4"	Carbide black

For RockerBall™ products
see page 86



Scan to
learn more

COMFORT. CONTROL. CONFIDENCE.



2
INCH & **2½**
INCH

REBELLION™ XD ADJUSTABLE CUSHION HITCH DUAL-BALL MOUNTS

- Reduces shock loads to the vehicle during sudden braking or acceleration
- Minimizes stress on tow vehicle's brakes and suspension for extended longevity
- Integrated rubber dampener for enhanced vibration resistance
- Cast steel construction with stainless steel fasteners, pins and clips
- Textured, dark grey teridium finish for a premium look on your vehicle
- Tested for safety to meet SAE J684
- Informative, full-color retail box
- Patent #11,685,206

• See page 138 for replacement parts



Enhanced comfort.

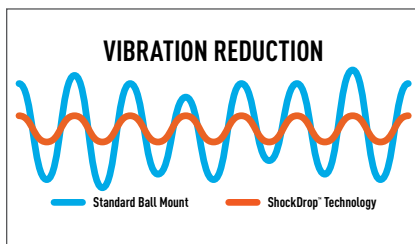

Unlike a traditional metal-on-metal towing connection, ShockDrop absorbs unevenness in the road to maximize comfort

Improved control.

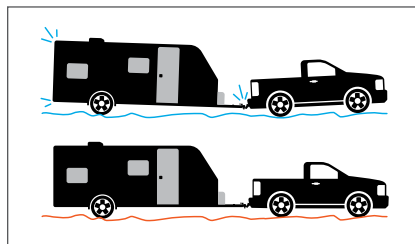

ShockDrop dynamically reacts to jarring, limiting its effects and giving the driver increased control on the road

Low maintenance.



Unlike a cushion hitch with an airbag or bearings, ShockDrop is virtually maintenance-free and is tested for 300K+ cycles

Part #	Shank Size	2" Ball GTW / TW	2-5/16" Ball GTW / TW	Max Drop	Length
45951	2"	10,000 / 1,000 lbs	15,000 / 1,500 lbs.	6"	12-1/4"
45955	2-1/2"	10,000 / 1,000 lbs	20,000 / 2,000 lbs	8"	14-1/4"

REBELLION™ XD PINTLE ACCESSORY

- Mounts onto CURT Rebellion™ XD adjustable shank
- Constructed from cast steel for optimum strength
- Weight capacity limited to Rebellion™ XD ball mount
- Includes four bolts to mount pintle hitch
- Attachment pins not included
- Dark grey teridium powder coat finish
- **See page 138 for replacement parts**

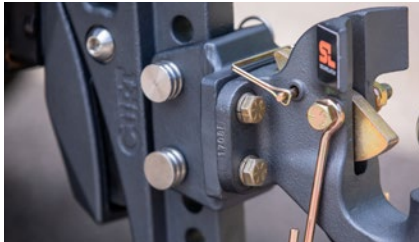

Accepts any CURT mount-style pintle hook or ball and pintle combination hitch



Integrated rubber dampener for enhanced vibration resistance



45950

Part #	Description	Dimensions	Capacity	Finish
45950	Pintle mount attachment	3-5/16" (W) x 1-3/4" (H) hole spacing	Limited to Rebellion XD ball mount	Dark grey teridium

REBELLION™ XD ACCESSORY LOCKS

- Locks replace standard clips and hitch pin for increased security
- Unique, integrated design fits all CURT Rebellion™ XD accessories
- Easy-to-operate, 1/4-turn lock activation
- Locks keyed alike for convenient one-key operation (#45932 only)



Locks replace standard clips and hitch pin for increased security



45932

45938

Part #	Description	Fits	Finish
45932	Tongue & hitch lock set	Hitch lock fits 2" and 2-1/2" receiver tubes	Black powder-coated aluminum and stainless steel
45938	Tongue lock only	Fits Rebellion XD shank pins only	Black powder-coated aluminum

2

INCH

&

2½

INCH

ADJUSTABLE DUAL-BALL MOUNTS

- Highly versatile design adapts to multiple vehicle-trailer combinations
- Adjustable dual ball allows for quick and precise trailer leveling
- Dual ball can be used on other weight distributing shanks (holes spaced 2-1/2" on-center)
- Shank can be flipped to provide necessary drop or rise (select models)
- Compatible with anti-rattle accessory to help stop vibration (see page 125)
- Built-in anti-rattle helps promote quiet towing
- Unique clip design installs easily over both pins and is vibration-resistant
- Dual-ball mount is compatible with Rebellion™ XD locks (see page 102)
- High-strength forged steel construction for dependable towing
- Durable carbide powder coat finish (trailer ball finish varies, see table)
- Informative, full-color retail box
- **See page 138 for replacement parts**



45935



45936



45937



45939



Dual ball attachment eliminates the need to carry extra attachments by providing two ball sizes in one



Anti-rattle technology promotes a quieter and smoother ride by preventing loud noises from the receiver coupling while towing



Deep-drop shank ideal for large or lifted trucks and SUVs (#45936, #45939)

Part #	Shank Size	2" Ball GTW / TW	2-5/16" Ball GTW / TW	Max Drop	Max Rise	Length	Ball Finish
45935	2"	10,000 / 1,000 lbs.	15,000 / 1,500 lbs.	5-1/2"	4-1/2"	12-1/4"	Chrome-plated
45936	2"	10,000 / 1,000 lbs.	15,000 / 1,500 lbs.	10"	9"	12-1/4"	Chrome-plated
45937	2-1/2"	10,000 / 1,000 lbs.	20,000 / 2,000 lbs.	5-1/2"	4-1/2"	14-1/4"	Yellow zinc-plated
45939	2-1/2"	10,000 / 1,000 lbs.	20,000 / 2,000 lbs.	11-3/4"	N/A*	14-1/4"	Yellow zinc-plated

* Not to be used in the rise position



EASILY CHANGE THE HEIGHT OF YOUR HITCH

2
INCH

&

2 1/2
INCH

DUAL-BALL ATTACHMENTS FOR WEIGHT DISTRIBUTION SHANKS

- Instantly transforms your weight distribution shank into an adjustable ball mount
- Fits standard weight distribution shanks with holes spaced 2-1/2" on-center
- Adjustable design allows for quick and precise trailer leveling
- Compatible with all CURT weight distribution shanks (sold separately, see page 195)
- Built-in anti-rattle helps promote quiet towing
- Unique clip design installs easily over both pins and is vibration-resistant (see page 103 for lock options)
- High-strength forged steel construction for dependable towing
- **See page 138 for replacement parts**



Part #	Fits Shank Size	2" Ball GTW / TW	2-5/16" Ball GTW / TW	Includes	Ball Finish
45933	2"	10,000 / 1,000 lbs.	15,000 / 1,500 lbs.	Dual ball, two pins and clip	Chrome-plated
45934	2-1/2"	10,000 / 1,000 lbs.	20,000 / 2,000 lbs	Dual ball, two pins and clip	Yellow zinc-plated



ADAPT YOUR HITCH TO ANY SITUATION

2 INCH & 2½ INCH & 3 INCH ADJUSTABLE CHANNEL MOUNTS

Check out our WD adjustable mounts! See page 104

Product Details

- Adjustable channel allows for precise trailer leveling
- Shank can be flipped for max rise or drop
- Two hitch pin holes provide varying shank length
- Built-in anti-rattle helps promote quiet towing
- Channels measure 3" wide (I.D.) with holes spaced 1" on center (excl #45903 slim)
- Durable carbide black powder coat finish
- Includes hitch pin & clip and accessory pins & clips
- Patent #8,033,563 (excl #45901 ball mount)
- Informative, full-color retail packaging



45903 packaging

Dual-ball

- Available in 2", 2-1/2" and 3" shank sizes
- Deep drop configurations for larger, lifted trucks



Slim-style

- Weighs only 15 lbs. for easy handling
- One-pin ball attachment for quick, easy adjustment



Hook & step dual-ball

- Tow hook perfect for vehicle recovery and straight-line pull applications
- Non-skid step for easy truck bed access



Pintle-style

- Available in 2" and 2-1/2" shank sizes
- Fits 2-5/16" couplers or lunette eyes with a 2-1/2" or 3" inside diameter



Ball mount

- 1" hole will accept a trailer ball shank



2
INCH

&

2½
INCH

&

3
INCH

ADJUSTABLE CHANNEL MOUNTS

Check out our WD adjustable mounts! See page 104



Part #	Shank Size	2" Ball GTW	2-5/16" Ball GTW	Tow Hook Capacity	Ball Mount GTW	Max Drop	Max Rise	Length	Ball Finish
45903	2"	8,000 lbs.	10,000 lbs.	--	--	3-3/4"	3-1/2"	10" / 11"	Yellow zinc-plated
45901	2"	--	--	--	6,000 lbs.	6-3/4"	5-1/4"	11" / 12"	--
45900	2"	10,000 lbs.	14,000 lbs.	--	--	6"	5-1/4"	11" / 12"	Yellow zinc-plated
45902	2-1/2"	10,000 lbs.	20,000 lbs.	--	--	6"	5-1/4"	11" / 12"	Yellow zinc-plated
45904	2"	10,000 lbs.	14,000 lbs.	10,000 lbs.	--	6"	5-1/4"	11" / 12"	Yellow zinc-plated
45907	2"	--	13,000 lbs.	--	--	6"	5-1/4"	11" / 12"	Chrome-plated
45908	2-1/2"	--	20,000 lbs.	--	--	6"	5-1/4"	11" / 12"	Chrome-plated
45926	2"	10,000 lbs.	14,000 lbs.	--	--	10-1/8"	9-1/8"	11" / 12"	Yellow zinc-plated
45927	2-1/2"	10,000 lbs.	20,000 lbs.	--	--	10-3/8"	8-7/8"	11" / 12"	Yellow zinc-plated
45928	3"	10,000 lbs.	21,000 lbs.	--	--	10-5/8"	8-5/8"	11" / 12"	Yellow zinc-plated

ADJUSTABLE CHANNEL MOUNT ACCESSORIES

Hitch step

- Cast steel construction
- Folds up when not in use



Lock set

- Channel lock replaces one channel-mount pin
- Locks keyed alike for convenient one-key operation



Part #	Description	Tongue Weight	Step Width	Includes	Fits
45909	Hitch step	500 lbs.	16"	Hitch step only (no pins)	All channel mounts (excl. 45903)
23556	Lock set	--	--	5/8" hitch lock and channel lock	All channel mounts (excl. 45903) 2" or 2-1/2" receiver tubes

ALUMALITE™ ADJUSTABLE ALUMINUM BALL MOUNTS

NEW

- Lightweight, corrosion-resistant billet aluminum construction for easy handling
- Dual ball made from steel with a polished finish
- Adjustable dual ball for quick and precise trailer leveling
- Fits 2" receiver tube openings with 5/8" hitch pin hole
- Not intended for use in rise position
- Universal design for multiple vehicle-trailer setups
- Tested for safety in accordance with SAE J684
- Informative, full-color retail box



Adjustable in precise 1" intervals, making height adjustments easy with the 2" or 2-5/16" ball



Dual ball attachment eliminates extra attachments by providing two ball sizes in one



Can be flipped to a stowed position when not in use (excl #45364)

Part #	Shank Size	2" Ball GTW / TW	2-5/16" Ball GTW / TW	Drop	Length
45364 N	2"	8,000 / 800 lbs.	12,500 / 1,250 lbs.	3-1/2"	7-3/4" or 9"
45363 N	2"	8,000 / 800 lbs.	12,500 / 1,250 lbs.	5-1/2"	7-3/4" or 9"
45365 N	2"	8,000 / 800 lbs.	12,500 / 1,250 lbs.	7-1/2"	7-3/4" or 9"
45366 N	2"	8,000 / 800 lbs.	10,000 / 1,000 lbs.	9-1/2"	7-3/4" or 9"

2
INCH

ADJUSTABLE TRI-BALL MOUNT

- Fits any 2" x 2" receiver tube opening
- Adjustable height allows for precise trailer leveling
- Includes three 5/8" diameter pins & clips
- Compatible with anti-rattle accessory to help stop vibration (see page 125)



45799

Part #	GTW	Ball Diameter	Max Drop	Max Rise	Length
45799	6,000 / 7,500 / 10,000 lbs.	1-7/8", 2", 2-5/16"	5-3/4"	5-3/4"	16"

2
INCH

ADJUSTABLE MULTI-PURPOSE BALL MOUNT

- Fits any 2" x 2" receiver tube opening
- Adjustable height allows for precise trailer leveling
- Includes three 5/8" diameter pins & clips
- Patent #8,534,695



Welded trailer balls and clevis bar for lunette rings



45049

Part #	Ball Diam. and Max GTW / TW		Clevis Bar Capacity	Max Drop	Max Rise	Length
	2"	2-5/16"				
45049	7,500 / 750 lbs.	10,000 / 1,000 lbs.	10,000 lbs.	4-1/2"	6-1/2"	14-3/16"

2
INCH

ADJUSTABLE BALL MOUNT

- Fits any 2" x 2" receiver tube opening
- Adjusts in 1-1/2" increments for precise trailer leveling
- Compatible with anti-rattle accessory (see page 125)
- Includes pin & clip (#21500)

Part #	GTW / TW	Max Drop	Max Rise	Length	Tongue Hole Size	Finish
45812	5,000 / 500 lbs.	7-1/2"	6-1/4"	12-1/2"	1"	Gloss black



45812
drop

45812
range

2 INCH & 2 1/2 INCH MULTI-BALL MOUNTS

- Fits 2" or 2-1/2" receiver tube openings
- Allows for quick switching between trailer ball sizes
- Permanently attached hook or trailer balls cannot be loosened or stolen
- Compatible with anti-rattle accessory to help stop vibration (see page 125)
- **See page 138 for replacement parts**



Hollow Shank #	Solid Shank #	Trailer Balls	Ball Diameter and Maximum GTW / TW			Length	Ball Finish	Shank Finish
			1-7/8"	2"	2-5/16"			
For 2" x 2" Receiver Tube Openings								
--	45660	2	--	7,500 / 750 lbs.	10,000 / 1,000 lbs.	8-1/2"	Black	Gloss black
45002	45665	2	--	7,500 / 750 lbs.	10,000 / 1,000 lbs.	8-1/2"	Chrome	Gloss black
--	45675*	3	3,500 / 350 lbs.	5,000 / 500 lbs.	10,000 / 1,000 lbs.	7" and 8-1/2"	Chrome	Gloss black
45652	45650	3	5,000 / 500 lbs.	7,500 / 750 lbs.	10,000 / 1,000 lbs.	7" and 8-1/2"	Black	Gloss black
45001	45655	3	5,000 / 500 lbs.	7,500 / 750 lbs.	10,000 / 1,000 lbs.	7" and 8-1/2"	Chrome	Gloss black
For 2-1/2" x 2-1/2" Receiver Tube Openings								
45651	--	3	5,000 / 500 lbs.	10,000 / 1,000 lbs.	14,000 / 1,400 lbs.	7-1/4" and 8-1/4"	Black	Gloss black

* Tow hook limited to trailer hitch capacity

CLEVIS PINS

- Heavy-duty hitch pin for hitch accessories or towing with a UTV or lawn tractor
- Extra-wide, rubber-coated handle for better grip
- Welded steel construction with powder-coated pin
- Includes cotter pin
- Not rated for road use



Part #	Pin Diameter	Usable Pin Length	Pin Finish
45805	1/2"	3-5/8"	Black powder coat
45804	5/8"	4"	Black powder coat
45809	3/4"	5-1/2"	Black powder coat
45803	1"	5-1/2"	Black powder coat

2 INCH CLEVIS PIN BALL MOUNT

- Fits any 2" x 2" receiver tube opening
- Clevis pin accepts a tow hook or strap (also compatible with #45803 1" clevis pin)
- Can also be used as a standard ball mount
- Includes clevis pin (trailer ball sold separately)
- Solid steel shank for optimum strength



Part #	GTW / TW	Length	Tongue Hole Size	Finish
45821	6,000 / 600 lbs.	8-3/4"	1"	Gloss black

2 INCH & 2 1/2 INCH D-RING SHACKLE AND TOW HOOK MOUNTS

- Fits 2" or 2-1/2" receiver tube openings
- GTW and TW are limited to the lowest-rated towing component



Can be used with CURT vehicle recovery strap 83066 or similar

Part #	Shank Size	Description	Length	Finish
45832	2"	Use with tow straps, complete with shackle and solid shank	7-1/2"	Carbide black
45831	2-1/2"	Use with tow straps, complete with shackle and solid shank	7-1/2"	Carbide black
45825	2"	Use with 83066 vehicle recovery strap or similar	7-1/2"	Gloss black
45500	2"	Use with 83066 vehicle recovery strap or similar	10"	Carbide black

TOW HOOKS & TOW STRAP

See page 295 for chain options

- Commonly used on 4WD pickups, SUVs and vans
- Constructed from forged, heat-treated steel
- Spring clip provides added security for rope or strap attachment
- Tow strap (#83066) is more compact than rope and stronger and lighter than chain



Bulk #	Pkg #	Description	Capacity	Break Strength	Finish
--	22401	Tow hook with hardware	10,000 lbs.	--	Chrome-plated
--	22411	Tow hook with hardware	10,000 lbs.	--	Black
22420	--	Tow hook	10,000 lbs.	--	Chrome-plated
22430	--	Tow hook	10,000 lbs.	--	Black
83066	--	Tow strap, 2" wide by 30' long	9,000 lbs. GVW	18,000 lbs.	Nylon

2

INCH

SPECIALIZED ADAPTERS

- Fits any 2" x 2" receiver tube opening
- Top receiver increases ground clearance for a cargo carrier or other hitch-mounted accessories
- Top receiver not for towing use
- Provides two receiver tubes for multiple accessories, such as a cargo carrier and a ball mount (#45792)
- Ideal for carrying a bike rack while towing a trailer (#45810)



45794



45792



45810



45794 provides added ground clearance



45792 provides two receiver tubes



45810 provides a ball mount and receiver tube to tow a trailer and an additional accessory



Part #	Description	GTW / TW	Drop	Rise	Length	Hole Size	Finish
45794	Raised receiver adapter (only for use in the rise position)	Not for towing use / 350 lbs.	--	4-1/4"	5-1/4"	--	Gloss black
45792	Dual receiver extender with pin & clip	3,500 / 350 lbs.	--	5-13/16"	8"	--	Gloss black
45810	Multi-use ball mount with pin & clip	7,500 / 750 lbs.	2"	5-13/16"	12-1/4"	1"	Gloss black

ATV

2

INCH

ATV TOWING STARTER KITS

- Kit includes 3-in-1 ATV ball mount, bolt-on ATV adapter and pin & clip
- Never exceed the ATV's maximum tow rating
- Ball mount features a trailer ball, 5/8" hole and a clevis pin
- Adapter bolts onto ATV tongue to provide a 2" x 2" receiver tube
- Welded D-ring accepts tow straps or hooks
- Durable gloss black powder coat finish
- Not rated for road use
- Patent #8,915,514 and #8,276,932



Installs on ATV and provides a variety of hook-up options



No-swivel design



45006



45005



45029

Kit #	Ball Mount #	Adapter #	Ball Diameter	Rise	Length	Hole Size
45029	45005	45006	1-7/8"	1/4"	6"	5/8"
45038	45009	45006	2"	1/4"	6"	5/8"

CAUTION: Use of adapters and extenders can reduce tongue weight or vertical load capacity of the vehicle's hitch. Products under 12" reduce load capacity by 25%. Products over 12" reduce load capacity by 50%.

2 INCH & 2½ INCH & 3 INCH TRAILER HITCH RECEIVER TUBE ADAPTERS & EXTENDERS

Adapters

- Adapts a receiver tube opening to a different size
- #45048 can be cut down from 34" to 24" and has integrated safety chain loops and electrical bracket



Extenders

- Solid steel shank for optimum strength



Adds clearance for a trailer or hitch-mounted accessory (45791)



Moves coupling point farther from the vehicle to avoid obstructions

Measuring adapters and extenders



Length is measured between pin-holes, from center to center

Part #	Adapts From	Adapts To	GTW / TW	Weight Dist. GTW / TW	Length	Finish
Adapters						
45785	1-1/4"	2"	Not for towing use / 350 lbs.	--	6-1/4"	Gloss black
45790	1-1/4"	2"	Not for towing use / 350 lbs.	--	10"	Gloss black
45770	2"	1-1/4"	3,500 / 350 lbs.	--	4"	Gloss black
45775	2"	1-1/4"	3,500 / 350 lbs.	--	9-1/2"	Gloss black
45013	Vertical 2"	Standard 2"	5,000 / 500 lbs.	--	4-1/4"	Gloss black
45048	2-1/2"	2"	4,500 / 450 lbs. 6,000 / 600 lbs.	6,000 / 600 lbs. 8,000 / 800 lbs.	34" 24"	Gloss black
Extenders						
45789	--	--	Not for towing use / 350 lbs.	--	7"	Gloss black
45791	--	--	3,500 / 350 lbs.	--	8"	Gloss black
45781*	--	--	3,500 / 350 lbs.	--	8"	Gloss black
45795	--	--	3,500 / 350 lbs.	--	14"	Gloss black
45796	--	--	3,500 / 350 lbs.	--	18"	Gloss black

* Hollow shank

3 INCH → **2½** INCH → **2** INCH **REDUCER SLEEVES**

For master and inner pack quantities see page 349

- #45408 set reduces a 3" receiver tube opening to fit a 2" or 2-1/2" shank
- Limited to the lowest-rated towing component



45408 set includes two reducers to fit multiple accessories



Reduces the receiver tube opening to fit smaller shank sizes

Part #	Reduces From	Reduces To	Length	Finish
45405	2-1/2"	2"	5-1/2"	Carbide black
45409	3"	2-1/2"	6-1/4"	Carbide black
45408*	3" 2-1/2"	2-1/2" 2"	6-1/4"	Carbide black

How to use a reducer sleeve

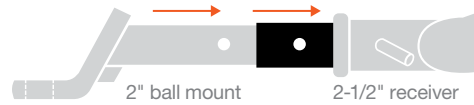

* 2-1/2" to 2" inner sleeve only designed for 2-1/2" receiver tubes with 2-1/4" from the collar to the hitch pin hole

1¼ INCH & **2** INCH **VERTICAL RECEIVER TUBE BALL MOUNTS**

- Converts a vertical receiver tube into a ball mount tongue (#45507, #45003)
- Adapts a 2" vertical receiver into a 2" standard receiver (#45013)



Part #	Shank Size	GTW / TW	Tongue Hole Size	Adapts From	Adapts To	Length	Finish
45507	1-1/4"	3,500 / 300 lbs.	3/4"	Vertical 1-1/4"	Ball mount tongue	9-3/4"	Gloss black
45003	2"	4,000 / 400 lbs.	1"	Vertical 2"	Ball mount tongue	9"	Gloss black
45013	2"	5,000 / 500 lbs.	--	Vertical 2"	Standard 2"	4-1/4"	Gloss black

TOWING SECURITY

HITCH PINS & CLIPS

For master and inner pack quantities see page 349

- Secures ball mounts and other receiver tube inserts
- Bent handle for an easier grip



Bent handle for an easier grip during insertion and removal



Vinyl-coated pin & clip for a more solid, easy grip (select models)



Grooved pin allows clip insertion at any angle (select models)



High-strength steel construction with a durable zinc-plated finish

Bulk #	Pkg #	Three-Pack#	Fits Tube Size	Pin Diameter	Finish	Clip Attachment
21400	21401	--	1-1/4" x 1-1/4"	1/2"	Zinc-plated	Hole
21403	21404	--	1-1/4" x 1-1/4"	1/2"	Zinc-plated	Groove
21410	21411	--	1-1/4" x 1-1/4"	1/2"	Zinc-plated, coated grip	Hole
--	21502	--	1-1/4" x 1-1/4" 2" x 2"	1/2" 5/8" adapter	Zinc-plated	Hole
21500	21501	--	2" x 2"	5/8"	Zinc-plated	Hole
21504	21505	--	2" x 2"	5/8"	Zinc-plated	Groove
21510	21511	--	2" x 2"	5/8"	Zinc-plated, coated grip	Hole
21578	21579	--	2" x 2"	5/8"	Black zinc-plated	Hole
21580	21581	--	2" x 2"	5/8"	Zinc-plated	Hole
21582	21583	--	2-1/2" x 2-1/2" 2" x 2" 2-1/2" x 2-1/2"	5/8"	Zinc-plated	Groove
21507	21506	--	2-1/2" x 2-1/2" 3" x 3"	5/8"	Zinc-plated	Groove
21600	21601	21602	--	Fits 1/2" or 5/8"	Zinc-plated	--

SWIVEL HITCH PINS

For master and inner pack quantities see page 349

- Quickly secures ball mounts and other receiver tube inserts with no clip needed
- Permanently attached swivel clip cannot be lost
- Bent handle for an easier grip



Part #	Fits Tube Size	Pin Diameter	Finish	Description
21541	1-1/4" x 1-1/4"	1/2"	Chrome-plated	Swivel pin
23581	1-1/4" x 1-1/4"	1/2"	Stainless steel	Swivel pin
21551	2" x 2"	5/8"	Chrome-plated	Swivel pin
23582	2" x 2"	5/8"	Stainless steel	Swivel pin
21561	1-1/4" x 1-1/4" 2" x 2"	1/2" 5/8"	Zinc-plated	Swivel pin with adapter sleeve



Quickly secures shank with no additional clip needed

SAFETY PINS

- Quickly secures coupler latches, pintle hooks, jack legs or caster wheels
- Square retainer wire clip provides added clearance
- Protected by a durable zinc-plated finish



Bulk #	Pkg #	Pin Diameter	Pin Length	Chain Length
25080	25081	1/4"	2-3/4"	--
25012	25013	1/4"	2-3/4"	12" chain
25010	25011	5/16"	3"	--
25034	25035	5/16"	3"	12" chain
28278	28279	3/8"	2-3/4"	--
28000	28001	3/8"	3"	12" chain



25034 securing a coupler latch



28278 securing a jack foot

HITCH LOCKS

For master and inner pack quantities see page 349

- Easy-to-operate, 1/4-turn lock activation
- Watertight dust cap prevents internal corrosion
- Two keys included for added convenience
- Space-saving, full-color retail packaging
- Keyed-alike for added convenience (#23515-KA)



Part #	Keyed Alike #	Fits Tube Size	Pin Diameter	Finish	Lock Style
23020	--	1-1/4" x 1-1/4"	1/2"	Chrome-plated	Dead bolt
23501	--	1-1/4" x 1-1/4"	1/2"	Chrome-plated	Barbell
23024	--	1-1/4" x 1-1/4" 2" x 2"	1/2" 5/8"	Chrome-plated	Dead bolt with adapter sleeve
23517	--	1-1/4" x 1-1/4" 2" x 2"	1/2" 5/8"	Stainless steel	Barbell with adapter sleeve
23506	--	1-1/4" x 1-1/4" 2" x 2"	1/2" 5/8"	Chrome-plated with blue anodized aluminum	Barbell, right angle with adapter sleeve
23515	23515-KA	2" x 2"	5/8"	Chrome-plated	Barbell
23516	--	2" x 2"	5/8"	Stainless steel	Barbell
23518	--	2" x 2"	5/8"	Black zinc	Barbell
23502	--	2" x 2"	5/8"	Stainless steel with blue anodized aluminum	Barbell, right angle
23510	--	2" x 2"	5/8"	Chrome-plated	Barbell, right angle
23528	--	Up to 2-1/2"	5/8"	Chrome-plated	Barbell
23519	--	Up to 2-1/2"	5/8"	Stainless steel	Barbell
23504	--	Up to 2-1/2"	5/8"	Chrome-plated with blue anodized aluminum	Barbell, right angle
23021	--	Up to 3"	5/8"	Chrome-plated	Dead bolt
23025	--	Up to 3"	5/8"	Chrome-plated	Barbell





HITCH & COUPLER LOCK SETS

- Lock sets locks keyed alike for convenient one-key operation
- Easy-to-operate, 1/4-turn lock activation
- Watertight dust caps prevent internal corrosion
- Space-saving, retail packaging



Part #	Fits Tube Size	Fits Latch Span	Fits Coupler	Lock Pin Diameter	Coupler Pin Diameter	Finish	Includes
23526	2" x 2"	7/8"	Latches	5/8"	1/4"	Chrome-plated	Hitch lock (23515) & coupler lock (23520)
23527	2" x 2"	2-1/2"	Latches	5/8"	1/4"	Chrome-plated	Hitch lock (23515) & coupler lock (23522)
23505	2" x 2"	Adjustable from 1" to 3"	Latches	5/8"	1/4"	Chrome with blue anodized aluminum	Hitch lock & coupler lock (23503)
23083	Up to 2-1/2"	Adjustable from 1" to 3"	Latches and 1-7/8", 2" and 2-5/16" couplers	5/8"	1/4"	Chrome with blue anodized aluminum (hitch & coupler lock) Orange polymer (coupler lock)	Hitch lock (23504) & coupler lock (23082)
23092 N	Up to 2-1/2"	--	1-7/8", 2" and 2-5/16"	5/8"	--	Chrome-plated (hitch lock) Orange polymer (coupler lock)	Hitch lock (23528) & coupler lock (23090)

COUPLER LATCH LOCKS

- Easy-to-operate, 1/4-turn lock activation
- Watertight dust cap prevents internal corrosion (select models)
- Two keys included for added convenience
- Space-saving, full-color retail packaging
- Keyed-alike for added convenience (#23520-KA)



Part #	Keyed Alike #	Fits Latch Span	Pin Diameter	Finish	Lock Style
23546	--	3/4"	1/4"	Solid brass	Padlock
23022	--	3/4"	1/4"	Brass-plated	Padlock
23521	--	3/4"	1/4"	Black	Padlock
23520	23520-KA	7/8"	1/4"	Chrome-plated	Barbell
23522	--	2-1/2"	1/4"	Chrome-plated	Barbell
23523	--	3-3/8"	1/4"	Chrome-plated	Barbell
23503	--	Adjustable from 1" to 3"	1/4"	Chrome with blue anodized aluminum	Barbell, right angle



Secure your trailer from theft (23503 shown)

UNIVERSAL TRI-BALL COUPLER LOCK

- Highly theft and tamper-resistant design
- Simple lasso design keeps all parts together
- Glass-filled orange polymer for high strength and increased visibility
- Easy-to-operate, 1/4-turn lock activation
- Keyed-alike for added convenience (#23083)
- Patent # US11577564B2

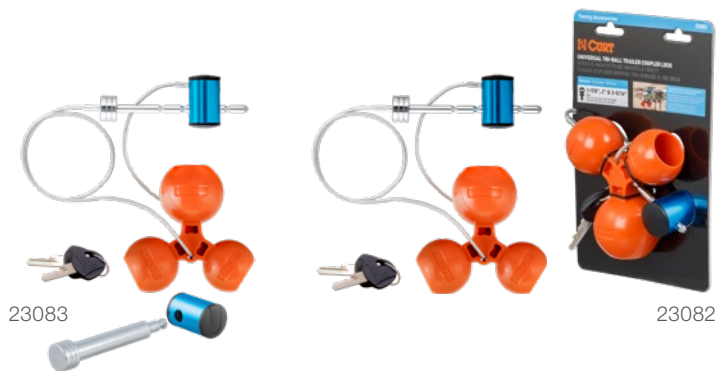

Unique tri-ball inserts into coupler and secures latch with lasso lock



Coupler lock can also be used while towing to secure the trailer



Built-in safety points allow the ball to break off when forcefully tampered with, leaving the ball in the coupler and blocking hookup



Part #	Fits Coupler Size	Fits Tube Size	Fits Latch Span	Coupler Pin Diam.	Includes
23082	1-7/8", 2" and 2-5/16"	--	Adjustable from 1" to 3"	1/4"	Coupler lock only
23083	1-7/8", 2" and 2-5/16"	2" x 2"	Adjustable from 1" to 3"	1/4"	Hitch lock (23504)



UNIVERSAL TRAILER COUPLER LOCK

- Prevents trailer ball from being inserted into the coupler
- Built with hardened steel and chrome-plated U-lock
- Bright color provides high-visibility theft deterrence
- U-lock inside width of 3-7/8" fits most trailers
- Includes two keys for added convenience
- Keyed-alike for added convenience (#23090-KA)



23090

NEW



23091



Deters theft by occupying and securing the coupler with a durable ratcheting lock



Insert the U-lock into the lock base and push downwards to set and secure the lock



Works with virtually all couplers, making it easy to use the lock on multiple trailers

Part #	Description	Fits Coupler Sizes	U-Lock Width	Finish
23090	Universal coupler lock	1-7/8", 2" and 2-5/16"	3-7/8" (inside)	Gloss orange powder coat
23090-KA N	Universal coupler lock, keyed alike	1-7/8", 2" and 2-5/16"	3-7/8" (inside)	Gloss orange powder coat
23091 N	Heavy-duty universal coupler lock	1-7/8", 2" and 2-5/16"	3-7/8" (inside)	Gloss orange powder coat
23092 N	Universal trailer lock set (incl. 5/8" hitch lock)	1-7/8", 2" and 2-5/16"	3-7/8" (inside)	Gloss orange powder coat

5TH WHEEL HITCH LOCK

- Locks a 5th wheel hitch into the rails, taking the place of a pin & clip
- Extra-long 1/2" diameter pin fits all industry-standard base rails
- Weather-resistant dust cap helps prevent internal corrosion
- Easy-to-access, 1/8-turn lock activation
- Includes two keys for added convenience

Part #	Pin Diameter	Finish
23256	1/2"	Black powder-coated aluminum



23256



Key slot angled upward for easier ergonomic access



Flush-mount on the base rail for enhanced security

KINGPIN LOCK

- Locks on to 5th wheel kingpin to deter theft
- Built with an aluminum body for corrosion resistance
- Two keys included for added convenience
- Space-saving, full-color retail packaging



23255



Universal design fits most 5th wheel trailer kingpins

Part #	Description	Finish
23255	5th wheel trailer kingpin lock	Chrome-plated steel and powder-coated aluminum

MULTI-USE DISK LOCKS

- Strong stainless steel body and hardened shackle for improved security
- Four-pin cylinder and dual locking mechanism helps prevent picking
- Weather-resistant finish avoids rust and corrosion
- Great for securing trailers, sheds and storage rooms
- Three-pack locks are keyed alike



23084

23085

Part #	Includes	Finish
23084	One lock	Stainless steel
23085	Three locks	Stainless steel



Shrouded disc design prevents attempts at cutting or prying



MULTI-USE CABLE LOCK

- Features versatile locking and cinching capabilities
- Protected by a vinyl coating for rust resistance



23666



Secures bike racks and cargo to deter theft

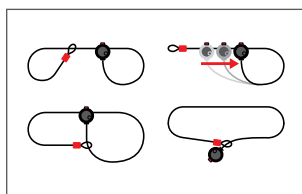

Features versatile locking and cinching capabilities

SPARE TIRE LOCK

- Fits side-mount spare tires
- Includes two keys for added convenience



23562



Secures spare tires to deter theft



Protected by a durable chrome-plated finish

Part #	Length	Cable	Finish
23666	6'	3/8" diameter	Vinyl-coated, braided steel

Part #	Fits	Finish
23562	Side-mount spare tires	Chrome-plated

TIRE LINC® AUTO TIRE PRESSURE MONITORING SYSTEM

- Provides push notifications when hazardous conditions occur to prevent blowouts
- Connects wirelessly through your smartphone via Bluetooth connection
- Repeater technology strengthens wireless signal for reliable connectivity
- Can be permanently wired with provided splice-in wiring harness
- Rechargeable 3.7V 5000mAh lithium battery for up to 60 hours of active use
- Automatically enters low-power mode when not in motion to preserve battery
- IP67-rated construction is dustproof and waterproof up to one meter
- Easy, do-it-yourself installation
- Portable design allows use with multiple trailers
- Sensors come with replaceable CR1632 batteries
- Additional trailer mounting brackets sold separately



Download the new OneControl® Auto app!



Provides real-time alerts

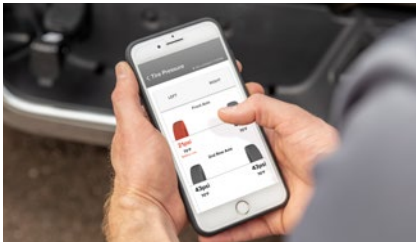

Actively monitors tire pressures and temperatures in real-time from a smartphone

Waterproof IP67 design



IP67-rated construction is dustproof and waterproof up to one meter

Monitor multiple tires



Monitor up to 20 tires simultaneously (additional sensors sold separately (#57011))

Part #	Description	Includes
57009	Tire Linc kit	Repeater, mounting bracket, hardware, four sensors, 120V USB wall charger and splice-in harness
57011	Tire Linc sensors	Two sensors
57017	Mounting plate	One mounting plate
57018	Splice-in charging cable	One splice-in charging cable
57019	USB charging cable	One USB charging cable

TRAILER SAFETY CHAIN HOLDER BRACKETS

- Provides intermediate hangers to keep safety chains off the ground (not intended as a safety chain secure point)
- Requires clearance on the shank between receiver collar and accessory (see table)
- Hooks maintain proper safety chain function for trailer disconnect



Provides intermediate hangers to keep chains off the ground

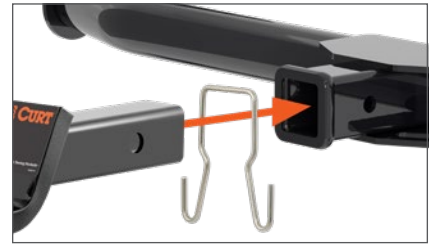
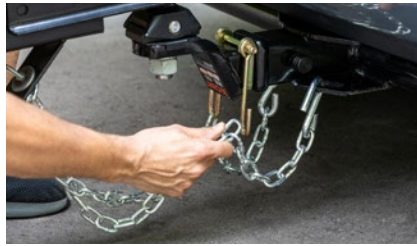

Easily clips onto most 2" shanks (#45807)

Part #	Fits	Style	Required Clearance	Includes	Finish
45806	2" shanks	Bolt-on	5/8"	Bracket and hardware	Yellow zinc-plated
45807	2" shanks	Clip-on	1/4"	Bracket only	Stainless steel

TRAILER-MOUNTED HD RUBBER WHEEL CHOCKS

- Convenient storage prevents dirt inside your truck or RV
- Snap-ring clips with wire lanyard store chocks and prevent lost pieces
- Ridged bottom surface prevents chock slip and movement
- Heavy-duty rubber and steel construction provides long-lasting durability



Quickly mounts your wheel chocks to your trailer frame for easy storage



Large handles in wheel chocks provide easy carrying and use

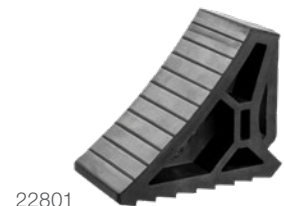
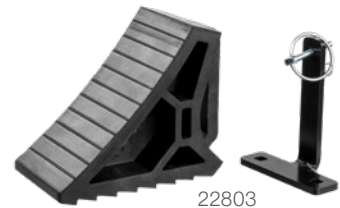

Part #	Includes
22801	One wheel chock
22803	One wheel chock, single-mount bracket and mounting hardware
22802	Two wheel chocks, dual-mount bracket and mounting hardware

WHEEL CHOCK SET

- Raised tread offers a better grip on the wheel
- Saw-tooth edges on the base provide solid traction on the ground
- Always to be used with emergency brake
- Nestable design for compact storage
- Not for commercial use



Adds safety during vehicle maintenance or to parked trailers



22800

Part #	Description
22800	For use with wheels up to 17" wide

ANTI-RATTLE HITCH CLAMPS & PINS

Clamp-style

- Stops rattling and prevents shank movement
- Compatible with hollow and solid shank accessories
- No-tool installation and easy-to-adjust clamp lever (#22320 and #22325 only)
- Lightweight aluminum and high-strength steel

Pin-style

- Stops rattling and prevents shank movement
- Compatible with hollow shank accessories
- Protected by a durable yellow zinc-plated finish



22325



22320

NEW



45367



22315



22323



Stops rattling and prevents shank movement for hollow and solid shanks (#45367 only)



No-tool installation and easy-to-adjust clamp lever (#22325, #22320 only)

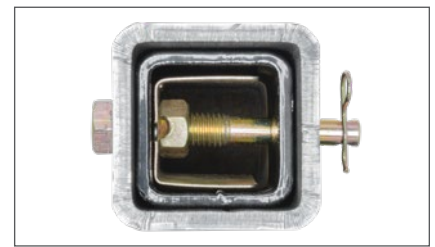

Insert into hollow-shanks to prevent sway and stop rattling (#22315, #22325 only)

Part #	Fits Shank Type	Fits Tube Size	Pin Diameter	Clip Attachment	Finish
Clamps					
22325	Hollow or solid	2" x 2"	--	--	Clear
22320	Hollow or solid	2-1/2" x 2-1/2"	--	--	Clear
45367 N	Hollow or solid	2" x 2"	--	--	Clear
Pins					
22315	Hollow only	1-1/4" x 1-1/4"	1/2"	Hole	Yellow zinc-plated
22323	Hollow only	2" x 2"	5/8"	Groove	Yellow zinc-plated



SECURELATCH™ SERIES AUTO-LOCKING TECHNOLOGY

SecureLatch™ streamlines the trailer hookup process with a revolutionary auto-locking design. Unlike any other coupling device, the primary latching mechanism automatically locks into place as you back up to the coupler. No manual coupling required! Simply insert the secondary safety pin, and you're ready to tow.

Scan to
learn more



How Auto-Locking Technology Works

1. Strike the plate.



As you back up the vehicle, a built-in back plate helps position the coupler or lunette ring for easier hookup

2. Lower the trailer.



As the coupler is lowered onto the pintle hitch, SecureLatch automatically locks without any manual coupling required

3. Tow with confidence.



Finally, insert the secondary safety pin, connect the safety chains and you're ready to tow with confidence and without chucking

What Makes SecureLatch™ Different?

Auto-locking system, no manual coupling

Available in various configurations

Austempered, cast iron for superior strength and wear resistance

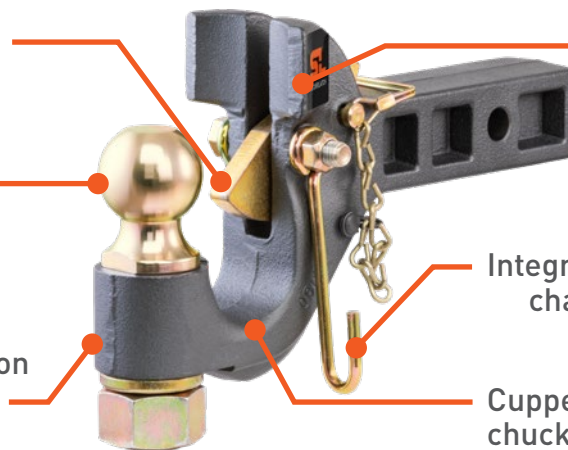

Built-in back plate for easier hookup

Integrated safety chain hangers

Cupped hook reduces chucking and noises



Offering a full series of hooks, mounts, channels and lunette rings!



PINTLES & MOUNTS

SL SECURELATCH™ PINTLE HOOKS & HITCHES

For lunette rings and pintle mounts see pages 128 & 129

- Non-shank models fit slotted SecureLatch™ or standard pintle mounts (holes spaced 1-3/4" high x 3-5/16" wide)
- Latch can be pinned in open position to clear standard trailer coupler (excluding hook models #48405, #48505)
- Textured, dark grey teridium finish for a premium look
- Yellow zinc-plated components for long-lasting corrosion resistance (bolt kit sold separately)
- Informative, full-color retail box or shank label
- U.S. patent# 9,789,742; Canadian patent# 2,836,683, 3,040,259 and 3,044,875; Australian patent# 2014366795; European patent# 14871983.4
- See page 138 for replacement parts



48407



48406



48405



48411



48410



48505

Bulk #	Pkg #	GTW*	Ball Capacity	Fits Tube Size	Ball Diameter	Overall Length	Ball Length	Hook Length	Fits Lunette Ring
Receiver-Mount Ball & Pintle Hitches									
48407	--	14,000 lbs.	10,000 lbs.	2"	2"	12-1/2"	9"	7"	2-1/2" or 3" I.D.
48406	--	14,000 lbs.	14,000 lbs.	2"	2-5/16"	12-1/2"	9"	7"	2-1/2" or 3" I.D.
Receiver-Mount Pintle Hooks									
48405	--	14,000 lbs.	--	2"	--	13-1/2"	--	9"	2-1/2" or 3" I.D.
Ball & Pintle Hitches									
--	48411	20,000 lbs.	10,000 lbs.	--	2"	--	--	--	2-1/2" or 3" I.D.
--	48410	20,000 lbs.	14,000 lbs.	--	2-5/16"	--	--	--	2-1/2" or 3" I.D.
Pintle Hooks									
--	48505	30,000 lbs.	--	--	--	--	--	--	2-1/2" or 3" I.D.

* Vertical load not to exceed 15% GTW or tow vehicle vertical weight limit



SLOTTED BOLT PLATE FOR MAXIMUM ADJUSTABILITY



SECURELATCH™ ADJUSTABLE PINTLE MOUNTS

Scan to
learn more



- Slotted bolt plate provides max adjustability, instead of fixed height positions
- Quick, easy, one-tool height adjustments – no disassembly required
- Torqued bolt plates provide 48,000 lbs. total clamp load for secure connection
- Accepts SecureLatch™ pintle hooks and ball hitches (sold separately)
- Cast iron construction is austempered for superior strength and wear resistance (#48016)
- High-strength cast steel construction (#48011)
- Textured, dark grey teridium finish for a premium look on your vehicle
- Yellow zinc-plated hardware for long-lasting corrosion resistance
- [See page 127 for pintles](#)

Measuring a pintle mount

See table for corresponding measurements



48011



48016

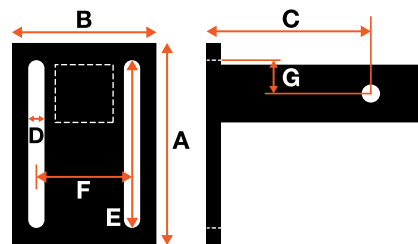

Bulk #	GTW	Plate Height (A)	Plate Width (B)	Shank Length (C)	Slot Width (D)	Slot Height (E)	Slot Space Width (F)	Top Slot Height (G)
For 2" x 2" Receiver Tube Openings								
48011	20,000 lbs.	9-1/2"	5"	6-7/8"	17/32"	7-3/4"	3-3/8"	1"
For 2-1/2" x 2-1/2" Receiver Tube Openings								
48016	20,000 lbs.	10-5/8"	5"	7-1/4"	17/32"	9"	3-3/8"	1-5/16"



SECURELATCH™ FLUSH-MOUNT LUNETTE RING

For pintles and mounts
go to pages 121 & 122

- Vertically offset base allows ring to be flipped for maximum height adjustment
- Drop-in pin accepts lock to deter theft (turns 90 degrees while coupled)
- Cast iron construction is austempered for superior strength and wear resistance
- Textured, dark grey teridium finish for a premium look on your trailer
- Yellow zinc-plated pin for long-lasting corrosion resistance
- Mounting hardware not included (#48553 sold separately)
- **See page 138 for replacement parts**



48661



Drop-in pin accepts lock to deter theft (turns 90° while coupled)

Part #	GTW	Rings Hole Size	Ring Thickness	Bolt Hole Spacing	Base Size
48661	60,000 lbs.	2-1/2" I.D.	1-1/2"	4-1/2" center to center	6-1/4" square



SECURELATCH™ CHANNELS & LUNETTE RINGS

Scan to
learn more



- Drop-in pin accepts lock to deter theft (turns 90 degrees while coupled)
- Strong 2-hole bolt pattern fits 3" channel only (#48625)
- Heavy-duty 3-hole bolt pattern fits 2-3/4" channel only (#48626)
- Cast iron construction for superior strength and wear resistance
- Hardware included with #48641 kit only
- Textured, dark grey teridium finish for a premium look on your vehicle (lunette rings only)
- Raw finish for immediate welding (channels only)
- Yellow zinc-plated pin for long-lasting corrosion resistance
- U.S. patent# 5,527,356; Canadian patent# 2,823,001; Australian patent# 2014305601
- **See page 138 for replacement parts**



48625

48626



48641



48651



48610



48650

Bulk #	Pkg #	GTW	Number of Positions	Ring Hole Size	Ring Thickness	Vertical Hole Spacing	Channel Width	Channel Height	Description
--	48625	25,000 lbs.	--	3" I.D.	1-1/2"	2" on center	3" I.D.	--	Lunette ring only
--	48626	40,000 lbs.	--	3" I.D.	1-1/2"	2" on center	2-3/4" I.D.	--	Lunette ring only
--	48641	40,000 lbs.	4-position	3" I.D.	1-1/2"	2" on center	2-3/4" I.D.	11-3/4"	Lunette ring and channel
48651	--	--	4-position	--	--	2" on center	2-3/4" I.D.	11-3/4"	Channel fits 48626 only
48610	--	--	3-position	--	--	2" on center	3" I.D.	7-1/2"	Channel only
48650	--	--	5-position	--	--	2" on center	3" I.D.	11-3/4"	Channel only

2
INCH

&

2½
INCH

FORGED PINTLE HOOKS & HITCHES

- Receiver style available to fit 2" or 2-1/2" receiver tube openings
- Flush-mount style fits any CURT pintle mount (excl. SecureLatch™)
- Spring-loaded locking arm for secure coupling
- Constructed from forged steel for superior strength
- Changeable trailer ball features a hard chrome finish (select models)
- Includes safety pin and bolt kit where applicable (hitch pin sold separately)
- See page 138 for replacement parts

48005
48004

48010

48006
48007

48012

48180
48190
4820048205
48210
48215
48231

Bulk #	Pkg #	GTW*	Ball Capacity	Fits Tube Size	Ball Diameter	Overall Length	Ball Length	Hook Length	Fits Lunette Ring
Receiver-Mount Ball & Pintle Hitches									
48006	--	16,000 lbs.	12,000 lbs.	2"	2-5/16"	15-1/4"	11-1/4"	9-1/2"	2-1/2" or 3" I.D.
48007	--	16,000 lbs.	10,000 lbs.	2"	2"	15-1/4"	11-1/4"	9-1/2"	2-1/2" or 3" I.D.
48012	--	20,000 lbs.	20,000 lbs.	2-1/2"	2-5/16"	15"	11"	9-1/2"	2-1/2" or 3" I.D.
Receiver-Mount Pintle Hooks									
48005	--	10,000 lbs.	--	2"	--	14-1/2"	--	9-1/2"	2-1/2" I.D.
48004	--	20,000 lbs.	--	2"	--	14-1/2"	--	9-1/2"	2-1/2" I.D.
48010	--	20,000 lbs.	--	2-1/2"	--	14-3/4"	--	9-1/2"	2-1/2" I.D.
Ball & Pintle Hitches									
--	48180	16,000 lbs.	6,000 lbs.	--	1-7/8"	--	--	--	2-1/2" or 3" I.D.
--	48190	16,000 lbs.	10,000 lbs.	--	2"	--	--	--	2-1/2" or 3" I.D.
--	48200	16,000 lbs.	16,000 lbs.	--	2-5/16"	--	--	--	2-1/2" or 3" I.D.
Pintle Hooks									
--	48205	10,000 lbs.	--	--	--	--	--	--	2-1/2" or 3" I.D.
--	48210	20,000 lbs.	--	--	--	--	--	--	2-1/2" or 3" I.D.
--	48215	30,000 lbs.	--	--	--	--	--	--	2-1/2" or 3" I.D.
--	48231	60,000 lbs.	--	--	--	--	--	--	2-1/2" or 3" I.D.

* Vertical load not to exceed 15% GTW or tow vehicle vertical weight limit

2 INCH & 2½ INCH PINTLE MOUNTS

- Mounts any CURT flush-mount style pintle hook or ball & pintle hitches
- Height adjustment allows for precise trailer leveling (for use in drop position only)
- Bent face plate and solid shank provides superior strength (#48343)
- 2-1/2" shank is ideal for class 5 Commercial Duty hitches (page 17)
- Protected by a highly durable carbide black powder coat finish
- Informative, full-color retail labels
- **See page 138 for replacement parts**

Measuring a pintle mount

See table for corresponding measurements

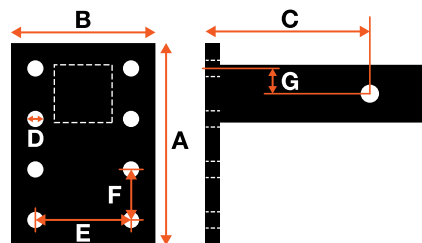

Part #	GTW	Pintle Positions	Plate Height (A)	Plate Width (B)	Shank Length (C)	Hole Size (D)	Hole Space Width (E)	Hole Space Height (F)	Top Hole Height (G)
For 2" x 2" Receiver Tube Openings									
48326	20,000 lbs.	1-position	3-1/2"	5"	6"	9/16"	3-5/16"	1-3/4"	7/8"
48327	20,000 lbs.	1-position	3-1/2"	5"	8"	9/16"	3-5/16"	1-3/4"	7/8"
48323	10,000 lbs.	3-position	7"	5"	6"	9/16"	3-5/16"	1-3/4"	7/8"
48324	10,000 lbs.	3-position	7"	5"	8"	9/16"	3-5/16"	1-3/4"	7/8"
48328	15,000 lbs.	3-position	7"	5"	6"	9/16"	3-5/16"	1-3/4"	7/8"
48325	15,000 lbs.	3-position	7"	5"	8"	9/16"	3-5/16"	1-3/4"	7/8"
48343	17,000 lbs.	3-position	7-1/4"	6-1/2"	6"	9/16"	3-5/16"	1-3/4"	7/8"
48341	10,000 lbs.	6-position	13"	5"	10"	9/16"	3-5/16"	1-3/4"	7/8"
48342	10,000 lbs.	6-position	13"	5"	12"	9/16"	3-5/16"	1-3/4"	7/8"
For 2-1/2" x 2-1/2" Receiver Tube Openings									
48340	20,000 lbs.	1-position	3-1/2"	5"	8"	9/16"	3-5/16"	1-3/4"	7/8"
48329	18,000 lbs.	3-position	7"	5"	8"	9/16"	3-5/16"	1-3/4"	7/8"
48348	20,000 lbs.	3-position	7-1/4"	5"	7-1/8"	9/16"	3-5/16"	1-3/4"	7/8"
48349	20,000 lbs.	6-position	12-1/2"	5"	7-1/8"	9/16"	3-5/16"	1-3/4"	7/8"

HITCH ACCESSORIES

1 1/4 INCH & 2 INCH & 2 1/2 INCH RUBBER HITCH TUBE COVERS

- Protects 1-1/4", 2" or 2-1/2" receiver tube opening
- Adds a clean, finished look and keeps debris out



Friction fit does not require a pin & clip to hold in place

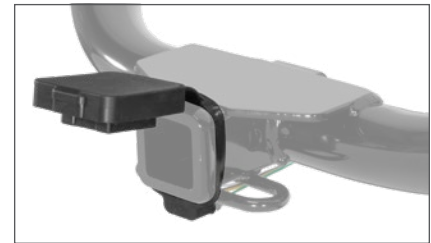

Convenient holder mounts a 4-way flat connector (21728)

Bulk #	Pkg #	Fits Tube Size	Style	Material
22271	22275	1-1/4" x 1-1/4"	Friction fit	Black rubber
22272	22276	2" x 2"	Friction fit	Black rubber
22279	--	2" x 2"	Friction fit with tube collar	Black rubber
--	21728	2" x 2"	Tube collar with 4-flat holder	Black rubber
22277	22278	2-1/2" x 2-1/2"	Friction fit	Black rubber

1 1/4 INCH & 2 INCH STEEL & PLASTIC HITCH TUBE COVERS

- Adds a clean, finished look and keeps debris out
- Available in high-strength steel or rust-free plastic
- Protected by a durable chrome-plated finish (#22101, #22111, #22171 only)
- Securely mounts using a pin and clip (not included)



Bulk #	Pkg #	Fits Receiver Tube Size	Finish
Steel Hitch Tube Covers			
22100*	22101	2" x 2"	Chrome-plated
--	22111	2" x 2"	Chrome-plated
22750	22751	2" x 2"	Black
Plastic Hitch Tube Covers			
22170	22171	2" x 2"	Chrome-plated
--	22181	2" x 2"	Black

* Continued while supplies last



Protects receiver tube openings when not being used for towing

PROTECTIVE GM MULTIPRO™ / MULTI-FLEX™ TAILGATE SENSORS

For more information go to page 166

- Prevents deployment of inner tailgate panel when ball mount is installed
- Helps avoid costly tailgate damage
- Easy installation requires no wire cutting or splicing
- No extra electronic components or batteries required
- Sleek, durable design suited for all work conditions



Part #	Fits Receiver Size	Includes
58267	2"	Sensor cap and wiring harness
58268	2-1/2"	Sensor cap and wiring harness

2 INCH GRIP STEP™ HITCH STEPS

- Fits any 2" x 2" receiver tube opening
- Provides a 26" hitch-mounted step on the front or rear of the vehicle
- Fleet-approved, expanded metal treads for maximum traction and safety
- Powder-coated aluminum construction to be strong, lightweight and rust-free
- 6" drop provides easier access into larger vehicles (designed for use in drop position only - #32002)
- Includes hitch pin & clip



Part #	Drop	Step Finish	Shank Finish
32001	--	Textured black	Black
32002	6"	Textured black	Black

2 INCH HITCH-MOUNTED ACCESSORIES

- Fits any 2" x 2" receiver tube opening
- For other hitch-mounted accessories like cargo carriers, bikes racks, and other cargo solutions, see page 308

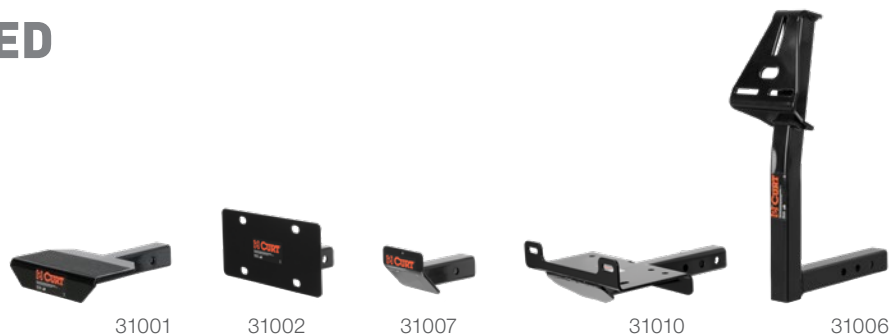

Part #	Description
31001	Step pad with anti-skid surface
31002	License plate holder
31007	Skid shield
31010	Winch mount
31006	Spare tire mount (mounting hardware not included)

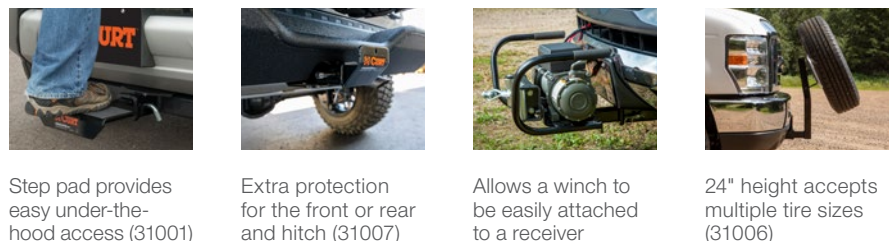

Step pad provides easy under-the-hood access (31001)

Extra protection for the front or rear and hitch (31007)

Allows a winch to be easily attached to a receiver

24" height accepts multiple tire sizes (31006)

EXTENDED VIEW TOW MIRROR

- Compatible with pickup or SUV left or right side mirror
- Fully adjustable design can be used in horizontal or vertical position
- Hinging arm and elastic straps provide easy and secure installation



Attaches to side mirror to expand view with a trailer



Articulating head allows precise angling



20002



Part #	Adds	Fits
20002	5" to 7-1/2" to existing mirror	Mirrors 4" to 11" high

FISH WIRE

- Makes it easier to lead bolts and spacers through tough-to-reach holes
- Ideal for installing a trailer hitch on a vehicle with a hollow frame
- Coiled end accepts threaded bolts



58390



58410



58400



58430

Part #	Length	Coil Diameter	Material
58390	18"	3/8"	Spring steel
58410	18"	7/16"	Spring steel
58400	18"	1/2"	Spring steel
58430	18"	5/8"	Spring steel



Ideal for installing a trailer hitch on a vehicle with a hollow frame

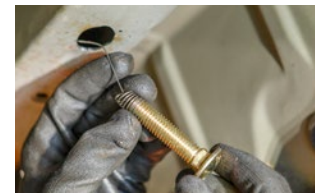

Makes it easier to lead hardware through tough-to-reach holes

PROFESSIONAL FINISHING PACK

- Great for hitch and wiring installations
- Features 11 commonly used automotive trim panel retainers and frame hole plugs

Part #	Description
22322	50 automotive finishing pieces in a poly bag

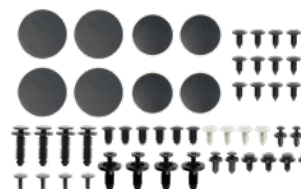

22322

HITCH ACCESSORY WALL MOUNT

- Simple, multi-function bracket to store hitch accessories when not in use
- Adds functionality to garages, sheds, shops or other storage spaces
- Great for holding cargo carriers, bike racks, ball mounts, tow bars and more
- Compatible with virtually any 2" or 2-1/2" shank hitch accessory
- Also compatible with shank accessories in the vertically mounted position
- Strong, welded steel construction with durable A-coat and powder coat finish



45069



45071



Improves garage organization by keeping accessories off the floor



Horizontal and vertical openings to mount accessories in either orientation



Narrow faceplate allows installation on a 2x4 stud or similar

Part #	Capacity	Shank	Includes	Finish
45069	350 lbs.	2"	Bracket and two lag bolts	Gloss black
45071 N	350 lbs.	2-1/2"	Bracket and two lag bolts	Gloss black

TOWING ACCESSORIES STORAGE BAG

- Great for chains, straps, greasy gooseneck ball and safety chain attachments
- Durable fabric with high-strength webbing straps
- Zipper closure to keep items secure
- Comfort-grip handles for easy portability



70004



Features 14 pockets for storage of small components



Great for storing and carrying towing accessories and related tools



Metal lining along the opening keeps bag open and upright for easy access

Part #	Inside Length	Inside Width	Inside Depth
70004	15"	8"	8"



POWER PRO MAX™ PORTABLE PRESSURE WASHER BY LIPPERT

- Battery powered, no fuel or power cords required
- Fast, three-hour charging time per battery
- Includes long and rotatable nozzles
- 6-in-1 spray attachment and 25 oz. soap bottle
- Includes two 40V lithium ion batteries
- Runs up to 26 minutes on high pressure and 35 minutes on low
- Cannot be connected to a garden hose



2020217218



Lightweight, portable design for at-home cleaning jobs or for spraying down camping gear, boats, piers, ATVs and more



6-in-1 spray attachment with long and short rotatable spray nozzles allow you to choose your cleaning style for every job



No hose, fuel or power cords required; simply drop your line in any water source and start cleaning

Part #	Run Time	Pressure	Weight
2020217218*	26 mins on high / 35 mins on low	520 max PSI	3.6 lbs.

* Continued while supplies last

FAB COMPONENTS



RAW STEEL RECEIVER TUBING

- Raw finish allows for immediate welding
- 1/2" reinforcing collar for increased strength
- Features a pre-drilled hitch pin hole



Part #	Finish	Receiver Tube Size	Tube Length
49506	Raw	1-1/4" x 1-1/4"	6"
49512	Raw	1-1/4" x 1-1/4"	12"
49524	Raw	1-1/4" x 1-1/4"	24"
49060	Raw	2" x 2"	6"
49090	Raw	2" x 2"	9"
49120	Raw	2" x 2"	12"
49180	Raw	2" x 2"	18"
49240	Raw	2" x 2"	24"
49360	Raw	2" x 2"	36"
49480	Raw	2" x 2"	48"
49516	Raw	2-1/2" x 2-1/2"	6"
49510	Raw	2-1/2" x 2-1/2"	10"
49511	Raw	2-1/2" x 2-1/2"	18"
49517	Raw	3" x 3"	12"
49518	Raw	3" x 3"	18"



2
INCH

RAW STEEL HITCH BARS

- Raw finish allows for immediate welding
- Rounded corners for easier insertion into the receiver
- Constructed from high-strength, hot-rolled steel
- Features a pre-drilled hitch pin hole



Part #	Finish	Bar Length	Shank Size
49537	Raw	8"	2" x 2"
49529	Raw	10"	2" x 2"
49530	Raw	12"	2" x 2"
49531	Raw	14"	2" x 2"
49533	Raw	18"	2" x 2"
49536	Raw	24"	2" x 2"

WELD-ON ACCESSORIES

- Reinforcing collar provides added strength (#49770)
- Accepts 2x4 studs or adds a tie-down for straps and chains (#83072)
- Provides a safety chain attachment point (#49950)

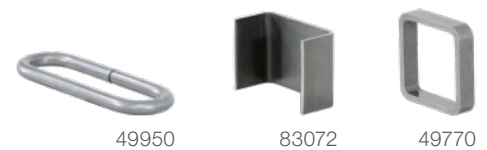

Part #	Description	GTW / TW	Receiver Tube Size	Height	Thickness	Inside Width	Inside Depth	Finish
49770	Reinforcement collar	--	2" x 2"	--	--	--	--	Raw
83072	Stake pocket	--	--	3"	3/16"	3-1/2"	1-5/8"	Raw
49950	Safety chain loop	10,000 lbs.	--	--	--	--	--	Raw

REPLACEMENT PARTS

TRAILER BALL HARDWARE KITS



Part #	Description	Fits
40103	3/4" nut and lock washer, qty 1	3/4" shanks
40104	1" nut and lock washer, qty 1	1" shanks
40105	1-1/4" nut and lock washer, qty 1	1-1/4" shanks

ADJUSTABLE DUAL-BALL MOUNTS

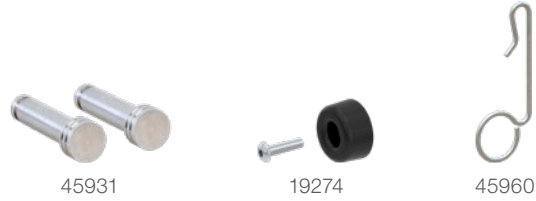

Part #	Description	Fits
45931	Accessory mount pins, qty 2	45935, 45936, 45937, 45939, 45933, 45934
45960	Accessory mount clip, qty 1	
19274	Anti-rattle bumper with screw, qty 1	

SWITCH BALL™ TRAILER BALLS



Part #	Description	Fits
41780	1-7/8" trailer ball, qty 1 - 6,000 lbs GTW - 1" neck hole diameter	42178, 41782
42780	1-7/8" trailer ball, qty 1 - 8,000 lbs GTW - 1-1/8" neck hole diameter	42225, 42280
42200	2" trailer ball, qty 1 - 8,000 lbs GTW - 1-1/8" neck hole diameter	42225, 42280
42203	2-5/16" trailer ball, qty 1 - 8,000 lbs GTW - 1-1/8" neck hole diameter	42225, 42280
41341	Shank, qty 1 - 3,500 lbs GTW - 2-1/4" length - 3/4" shank diameter - 1" neck diameter	41782

REBELLION™ XD CUSHION HITCHES



Part #	Description	Fits
45959	Accessory mount pins, qty 2	45951, 45955
45960	Accessory mount clip, qty 1	45951, 45955
19274	Anti-rattle bumper with screw, qty 1	45951, 45955
45940	Tongue mount, qty 1	45951, 45955
45952	Dual-ball, qty 1 (chrome) - 2" ball = 10,000 lbs. - 2-5/16" ball = 15,000 lbs.	45951
45953	Dual-ball, qty 1 (yellow) - 2" ball = 10,000 lbs. - 2-5/16" ball = 20,000 lbs.	45955

ADJUSTABLE CHANNEL MOUNTS



Part #	Description	Fits
45910	2" channel shank, qty 1	45900, 45904, 45907
45911	2" channel shank, qty 1	45901
45917	2-5/16" channel shank, qty 1	45902, 45908
45912	Dual-ball, qty 1	45900, 45926
45923	Dual-ball, qty 1	45902, 45927
45924	Dual-ball, hook and step, qty 1	45904
45919	Ball and pintle hitch, qty 1 - 10,000 lbs. GTW - 2" ball	All channel mounts
45920	Ball and pintle hitch, qty 1 - 13,000 lbs. GTW - 2-5/16" ball	45907
45922	Ball and pintle hitch, qty 1 - 20,000 lbs. GTW - 2-5/16" ball	45908
45916	Shank anti-rattle screw, qty 1	Previous models
45921	Shank anti-rattle bumper, qty 1	Previous models
19275	Attachment anti-rattle	All channel mounts
45925	Channel pins & clips, qty 2	All channel mounts

ADJUSTABLE MULTI-BALL MOUNTS



Part #	Description	Fits
45059	Adjustable shank, qty 1	45799, 45008
45800	Tri-ball head, qty 1	45799
45802	Receiver tube mount, qty 1	45799
45008	Dual-ball clevis head, qty 1	45049

PINTLE MOUNTS, HOOKS & HITCHES



Bulk #	Description	Fits
48549	SecureLatch pintle mount hardware: - 1/2" x 2" carriage bolts, qty 4 - 1/2" top lock nuts, qty 4 - Bolt plates, qty 2	48011, 48016
48334	Pintle hook & hitch hardware: - 1/2" socket head cap screws, qty 4 - 1/2" hex nuts, qty 4 - 1/2" lock washers, qty 4	48410, 48411, 48505, All forged pintles (excl. 48231)
48332	Forged pintle hook & hitch hardware: - 5/8" socket head cap screws, qty 4 - 5/8" hex nuts, qty 4 - 5/8" lock washers, qty 4	48231
48551	Safety chain hangers, qty 2	All
48420	2" ball (10,000 lbs.), qty 1	48407, 48411
48430	2-5/16" ball (14,000 lbs.), qty 1	48406, 48410
48810	1-7/8" ball (6,000 lbs.), qty 1	48180
48820	2" ball (10,000 lbs.), qty 1	48007, 48190
48830	2-5/16" ball (16,000 lbs.), qty 1	48006, 48200

CHANNELS & LUNETTE RINGS



Bulk #	Pkg #	Description	Fits
Lunette Rings			
48553	--	Hardware kit includes: - 3/4" hex bolts, qty 4 - 3/4" nylock nuts, qty 4 - 3/4" flat washers, qty 4	48560 48661
Channels			
48552	--	Hardware kit includes: - 5/8" hex bolts, qty 3 - 5/8" nylock nuts, qty 3 - 5/8" flat washers, qty 6	48641 48651 48610 48650



TOWING ELECTRICAL

FEATURED PRODUCTS

Scan QR code for current applications or visit curtmfg.com



Magnetic 4-flat connector

This innovative adapter transforms your existing 4-way flat into a magnetic, quick-snap connection that takes the hassle out of setup.



OEM connector with bracket

Simple plug-and-play design plugs into any USCAR socket to provide 4-way and 7-way trailer wiring connectors.



Trailer wire spools

CURT bulk trailer wire spools are a high-quality solution for rewiring trailers or similar applications.

PRODUCT INDEX



143
Brake
Controllers



149
Brake
Controller
Harnesses



153
Breakaway
Kits



154
Taillight
Converters



156
Custom
Wiring



159
USCAR
Products



162
Wiring Harness
Extensions



167
RV
Harnesses



168
Electrical
Adapters



174
Plugs, Sockets
& Brackets



181
Towing
Lights



182
Accessories
& Testers

TOWING ELECTRICAL SUBCATEGORY COLOR GUIDE

CURT has identified seven subcategories within the Towing Electrical category to make it easier for retail consumers to find the correct products. Each subcategory is given a unique color that we apply in our literature and retail packaging for easy visibility.



ELECTRICAL CONNECTOR WIRING GUIDE



- Rear views of plugs & sockets shown in the representative illustrations below
- Colors illustrated may not correspond with wiring found on the tow vehicle or trailer

7-way RV blade traditional configuration

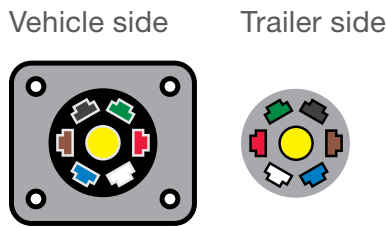

Function	Color
+12 volt	Black
Electric brakes	Blue
Reverse lights	Yellow
Left turn / brakes	Red
Right turn / brakes	Brown
Taillights	Green
Ground	White

6-way round

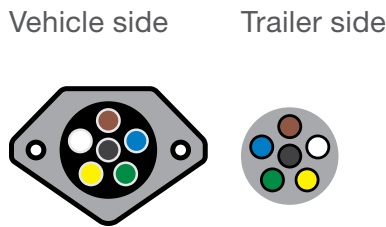

Function	Color
+12 volt	Black
Electric brakes	Blue
Left turn / brakes	Yellow
Right turn / brakes	Green
Taillights	Brown
Ground	White

4-way flat



Function	Color
Left turn / brakes	Yellow
Right turn / brakes	Green
Taillights	Brown
Ground	White

WIRING SYSTEMS

Two-wire system

The two-wire system is the simplest form of vehicle and trailer wiring and is still used by some vehicles today. This system sends the stop and turn signals along one wire, and the taillight signal along a second wire.

Three-wire system

The three-wire system is the most common in the automotive industry. It sends the stop, taillight and turn signals along three separate wires. Vehicles with this system usually require a converter.

PWM system

More and more vehicles today use a PWM (pulse width modulation) system. Sometimes called a 'multiplex,' this type of wiring is able to control multiple lighting functions through a single wire by varying the signal intensity. PWM systems can use incandescent or LED lights. There are generally two types: ST systems and STT systems.

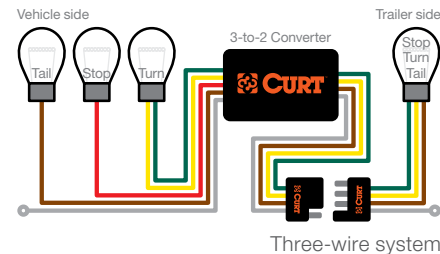

BRAKE CONTROLLERS

For a full list of benefits
see pages 144 - 147

- Easily calibrated for all towing needs
- Compatible with anti-lock brakes and cruise control
- Quick plug equipped for fast, easy installation
- Informative, full-color retail packaging

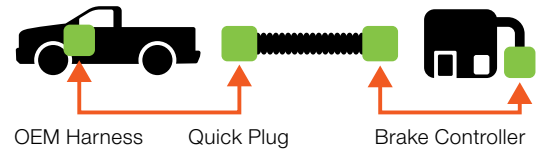

51200

Echo® in-line

Hidden under vehicle
Bluetooth-enabled
Smartphone-ready



51190

Echo® under-dash

Hidden under dash
Bluetooth-enabled
Smartphone-ready



51180

Echo® mobile

Portable design
Bluetooth-enabled
Smartphone-ready



51170

Spectrum™

Integrated OE look
Hidden main body
Tri-color LED display



51146

TriFlex™ NEXT

Tri-axis sensitivity
Auto adjustment
Digital display



51126

Discovery™ NEXT

Time-delay
Adjustable output
Digital display



51116

Venturer™ NEXT

Time-delay
Adjustable output
Ramp-up LED display

Dynamic power adjustment

Applies to Echo Series, Spectrum, Assure and TriFlex



4.0 ▶ **3.2** Automatic power reduction for incline

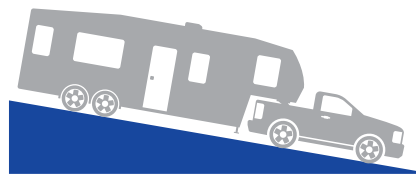

4.0 ▶ **5.3** Automatic power increase for decline



Tri-axis circuit detects inertia on three planes for greater sensitivity over dual-axis models

Note: Values represented are for illustration only. The actual preset and adaptive values may differ from those shown here.

Name	Pkg #	6-Pack #	Axles	Brakes	Activation Method	Display	Mount Angle	Sleep Mode	Electric Over Hydraulic	Warranty
Echo in-line	51200	--	1 - 4	2 - 8	Proportional	Phone app	Any	Yes	No	Ltd lifetime
Echo under-dash	51190	--	1 - 4	2 - 8	Proportional	Phone app	Any	Yes	No	Ltd lifetime
Echo mobile	51180	--	1 - 2	2 - 4	Proportional	Phone app	Any	N/A	No	Ltd lifetime
Spectrum	51170	--	1 - 4	2 - 8	Proportional	Tri-color LED	Any	N/A	No	Ltd lifetime
TriFlex NEXT	51146	511466 N	1 - 4	2 - 8	Proportional	LED digital	Any	Yes	No	Ltd lifetime
Discovery NEXT	51126	511266 N	1 - 4	2 - 8	Time-delay	LED digital	Any	Yes	Yes	Ltd lifetime
Venturer NEXT	51116	511166 N	1 - 3	2 - 6	Time-delay	LED digital	Any	Yes	Yes	Ltd lifetime



CONTROL ALL BRAKE SETTINGS FROM YOUR SMARTPHONE

**BRAKE
CONTROLLERS**

ECHO® SERIES BRAKE CONTROLLERS

For master and inner pack quantities see page 349

Powered by a bluetooth-enabled system and customizable app, Echo® provides the most advanced braking experience on the market. This unique controller utilizes your smartphone to control and monitor all trailer brake activity with no need for extra modules, controls, buttons or knobs.

Three Ways To Install Echo®

Echo® mobile



Zero-tool, plug-and-play install between vehicle-trailer 7-way connectors

Echo® under-dash



Plug-and-play install inside the vehicle with vehicle-specific quick plug harness (sold separately)

Echo® in-line



Plugs in behind existing 7-way socket outside the vehicle with USCAR connectors

Product Details

- Bluetooth connection to control all brake settings from your smartphone
- Custom-designed mobile app monitors brake activity and sends status updates
- Triple-axis, motion-sensing accelerometer for highly responsive, smooth stops
- Multi-color LED indicator for easy setup and troubleshooting
- Automatic calibration reduces setup requirements
- Clear, in-app warning system for voltage recognition and no-brake situations
- Allows incoming calls to be received while app is running
- Built-in reverse-polarity and short-circuit protection
- Compatible with low-volt, PWM, ABS, and cruise control
- If Bluetooth connection is lost, the brake controller will continue to function safely, using the most recently programmed settings
- Not compatible, but will not interfere, with Apple CarPlay or Android Auto



Download the new
OneControl® Auto app!



Product-Specific Features

Echo® mobile

- Wireless, portable design allows for easy transfer from one vehicle to another
- Zero-tool, plug-and-play install between vehicle-trailer 7-way connectors
- Potted circuit board is sealed off from the elements for lasting durability
- Retention strap and locking tab help keep Echo® firmly installed into 7-way
- Stores multiple vehicle-trailer profiles
- Operates 2-4 trailer brakes at a time (1-2 axles)
- Replacement strap available (#51186)

Scan to learn more about Echo®



51180

Echo® under-dash

- Simple installation using included adhesive or zip ties
- Plug-and-play install with vehicle-specific quick plug harness (sold separately, see page 149)
- Stores multiple trailer profiles
- Operates 2-8 trailer brakes at a time (1-4 axles)
- Sleep mode feature included to reduce power drain



51190

Echo® in-line

- Plugs in behind existing 7-way socket with USCAR connectors (24" USCAR extension harness included; other options available, see page 159)
- Waterproof enclosure seals and protects circuits against the elements
- Stores multiple trailer profiles
- Operates 2-8 trailer brakes at a time (1-4 axles)
- Sleep mode feature included to reduce power drain



51200

See page 159 for additional USCAR harnesses

BRAKE CONTROLLERS

ECHO® MANUAL OVERRIDE BUTTON

- Enables manual activation of trailer brakes
- Wireless accessory supports hands-free driving
- Compatible with all Echo® brake controllers and programmable for other Flic™ applications (Flic & Shortcut labs are trademarks of Shortcut Labs AB© 2020)
- Long-range Bluetooth maintains a strong connection
- Soft-touch material for comfortable use
- Replaceable battery with lifespan up to three years



51189 button
actual size (1-1/8")

Part #	Includes
51189	Double-sided adhesive pad for mounting



DASH-INTEGRATED OE LOOK AND FEEL

BRAKE CONTROLLERS

SPECTRUM™ BRAKE CONTROLLER

- Triple-axis, motion-sensing accelerometer for highly responsive, smooth stops
- Features two installation options: drill mount or surface adhesive mount
- User-selectable power output and trailer brake light activation
- Automatic leveling and calibration eliminate setup requirements
- Equipped with a quick plug for easy, plug-and-play installation
- Operates 2-8 trailer brakes at a time (1-4 axles)
- Built-in reverse-polarity and short-circuit protection
- Compatible with low-volt, PWM, ABS, and cruise control
- Tow vehicle 'low voltage' and trailer disconnect indicators



51170 interface
actual size (1-7/8")



51170 all
components



Controls manual override and all brake settings with a simple push-button rotary knob



Clean, dash-mounted, OEM-style user interface with 10 tri-color LEDs



Main module can be mounted out of sight to maintain a consistent, original equipment look

Product Details

- Slim, low-profile design for a functional, modern aesthetic
- Unique bracket system for improved dash clearance
- 10 gain settings and 9 load settings to adapt to various driving conditions
- Auto-sleep mode prevents battery drain after five minutes of idle time
- Compatible with low-volt, PWM, ABS, and cruise control
- Plug-and-play install with vehicle-specific quick plug harness (sold separately)

Quick release, slim bracket



Extra-slim mounting bracket reduces mounting height by 1/2" and features quick release tabs for easy installation and removal

Push button controls



Push-button operation allows for quick, easy adjustment compared to old-style switches and dial-operation

Full-text diagnostics



TriFlex and Discovery only

Clean, user-friendly interface offers full-text readouts and troubleshooting capabilities, simplifying operation and maintenance

Product-Specific Features



51146

TriFlex™ NEXT

- Triple-axis accelerometer for highly responsive, smooth stops and dynamic power adjustments when going up or down a hill
- LED display shows power adjustments in 0.5 increments
- Clean, easy-to-read interface with full-text readouts
- Day-night mode and adjustable brightness for optimal visibility
- Auto leveling and calibration eliminate setup requirements
- Built-in reverse-polarity and short-circuit protection
- Tow vehicle 'low voltage' and trailer disconnect indicators



51126

Discovery™ NEXT

- Fully adjustable power and ramp time
- No internal moving parts and no leveling required
- LED display shows power adjustments in 0.5 increments
- Day-night mode and adjustable brightness for optimal visibility
- Full-text diagnostics for easier troubleshooting
- Compatible with electric over hydraulic



51116

Venturer™ NEXT

- Fully adjustable power and ramp time
- No internal moving parts and no leveling required
- LED indicator lengthens as controller applies power
- Digital display shows power adjustments in 1.0 increments
- Adjustable brightness for optimal visibility
- Compatible with electric over hydraulic

BRAKE CONTROLLERS

COMPETITOR-TO-CURT ADAPTERS

- Allows CURT brake controllers and harnesses to be used with Tekonsha, Reese, Draw-Tite or Pro Series brake controllers and harnesses (Brands are registered trademarks of First Brands Group™)



Pkg #	Connects
51520	CURT controllers to competitor harnesses
51532	Competitor controllers to CURT harnesses

BRAKE CONTROLLERS

QUICK PLUGS WITH 24" PIGTAILS

- For vehicles not equipped with factory tow package wiring
- Splices into a vehicle for a quick plug brake controller connection
- Compatible with applicable CURT brake controllers
- Reduces input voltage from vehicle for optimal brake controller function (#51531 only)
- Eliminates backfeed on brake light that can cause warnings in select vehicles (#51531 only)



Bulk #	Pkg #	Description
51515	51516	Quick plug with 24" pigtails
--	51531	Quick plug with 24" pigtails and diode

BRAKE CONTROLLERS

BRAKE CONTROLLER WIRING KITS

Adapter with brake controller wiring kit

- Adapts a 4-way flat vehicle socket to fit 7-way RV blade trailer plugs
- Includes wiring and components to splice in a brake controller connection



Part #	Includes	Size	Qty
57186	Adapter (4-way to 7-way)	4-way flat to 7-way RV blade	1
	Cross-linked wire	10-gauge	25 feet
	Snap lock	12-10 gauge	1
	Flasher	--	1
	Circuit breaker	30-amp	1
	Circuit breaker	40-amp	1
	3/8" ring terminals	12-10 gauge	2
	#10 ring terminals	12-10 gauge	5
	Butt connectors	12-10 gauge	4
	Hex head screws	#10 - 3/4"	8
	Cable ties	8-1/2"	6

Universal brake controller wiring kit

- For tow vehicles not equipped with factory tow package wiring
- Compatible with 2, 4, 6 or 8-brake systems (1-4 axles)
- Designed for use with CURT quick plugs #51515 or #51516
- Brake controller and trailer connector not included



Part #	Includes	Size	Qty
51500	Duplex wire	10-gauge	10 feet
	Cross-linked wire	10-gauge	20 feet
	Circuit breaker	30-amp	1
	3/8" ring terminals	12-10 gauge	2
	#10 ring terminals	12-10 gauge	2
	1/2" ring terminals	12-10 gauge	2
	Butt connectors	12-10 gauge	3
	Cable ties	8-1/2"	8

BRAKE CONTROLLER HARNESS APPLICATIONS



51446

- Quick plug harness installs in less than ten minutes
- Connects a CURT brake controller to specific vehicle applications
- Includes 24" of wire for flexible installation
- Slit-loom keeps wires contained and protected

Scan for current applications
or visit curtmfg.com



Brake controller harness locations

BH1 - Under dash, left of steering column, near emergency brake pedal

BH2 - Under dash, near center console

BH3 - Under dash, in junction box left of steering column

BH4 - Behind storage pocket, above ashtray

BH5 - Under dash, behind center access panel on passenger side

BH6 - Under dash, near brake pedal

BH7 - Behind storage pocket in center of dash

BH8 - Under dash, to right of emergency brake pedal

Scan to learn
how to install



Make / Model (Style)	Years	Bulk #	Pkg #	Loc.
Acura				
MDX	18 - 22	51392	51393	BH1
	14 - 17	--	51523*	BH1
Audi				
e-tron GT / S / S Sportback	22 - 23	--	51522	BH2
e-tron Quattro	19 - 23	--	51522	BH2
e-tron Sportback	20 - 23	--	51522	BH2
Q5	09 - 24	--	51522	BH2
Q5 Sportback	21 - 24	--	51522	BH2
Q7	07 - 15	--	51522	BH2
Q8	19 - 24	--	51522	BH2
Q8 e-tron	24 - 24	--	51522	BH2
Q8 e-tron Sportback	24 - 24	--	51522	BH2
SQ5	14 - 17	--	51522	BH2
SQ7 / SQ8	20 - 24	--	51522	BH2
Buick				
Enclave	08 - 17	51422	51423	BH1
Cadillac				
Escalade	21 - 24	--	51525	BH1
	14 - 20	51451	51452	BH3, BH1
	03 - 06	51352	51353	BH3
	02 - 02	51342	51343	BH3
Escalade ESV	21 - 24	--	51525	BH1
	14 - 20	51451	51452	BH3, BH1
	03 - 06	51352	51353	BH3
Escalade EXT	03 - 06	51352	51353	BH3
	02 - 02	51342	51343	BH3
Chevrolet				
Avalanche 1500 / 2500	03 - 06	51352	51353	BH3
	02 - 02	51342	51343	BH3
Silverado 1500	19 - 25	--	51525	BH1
	14 - 18	51451	51452	BH3, BH1
	03 - 06	51352	51353	BH3
	99 - 02	51342	51343	BH3
Silverado 1500 Classic	07 - 07	51352	51353	BH3

Make / Model (Style)	Years	Bulk #	Pkg #	Loc.
Chevrolet (continued)				
Silverado 1500 HD	03 - 06	51352	51353	BH3
	01 - 02	51342	51343	BH3
Silverado 1500 HD Classic	07 - 07	51352	51353	BH3
Silverado 1500 LD	19 - 19	51451	51452	BH3, BH1
Silverado 1500 LTD	22 - 22	--	51525	BH1
Silverado 2500	03 - 04	51352	51353	BH3
	99 - 02	51342	51343	BH3
Silverado 2500 HD	20 - 25	--	51525	BH1
	15 - 19	51451	51452	BH3, BH1
	03 - 06	51352	51353	BH3
	01 - 02	51342	51343	BH3
Silverado 2500 HD Classic	07 - 07	51352	51353	BH3
Silverado 3500	03 - 06	51352	51353	BH3
	01 - 02	51342	51343	BH3
Silverado 3500 Classic	07 - 07	51352	51353	BH3
Silverado 3500 HD	20 - 25	--	51525	BH1
	15 - 19	51451	51452	BH3, BH1
Suburban	21 - 24	--	51525	BH1
	15 - 20	51451	51452	BH3, BH1
Suburban 1500	14 - 14	51451	51452	BH3, BH1
	03 - 06	51352	51353	BH3
	00 - 02	51342	51343	BH3
Suburban 2500	03 - 06	51352	51353	BH3
	00 - 02	51342	51343	BH3
Suburban 3500 HD	16 - 19	51451	51452	BH3, BH1
	21 - 24	--	51525	BH1
Tahoe	15 - 20	51451	51452	BH3, BH1
	03 - 06	51352	51353	BH3
	00 - 02	51342	51343	BH3

¹ Excluding factory integrated brake control - ITBC (Ram trucks)

² With factory tow package

*Continued while supplies last

Scan the QR code on page 149 for installation location diagram

Applications continued on the following page

BRAKE CONTROLLER HARNES APPLICATIONS

Make / Model (Style)	Years	Bulk #	Pkg #	Loc.
Traverse	09 - 17	51422	51423	BH1
Chrysler				
Aspen	07 - 09	51332	51333	BH1
Pacifica	17 - 24	51446 ²	51447 ²	BH8
Voyager	20 - 24	51446 ²	51447 ²	BH8
Dodge				
Dakota	97 - 10	51332	51333	BH1
Durango	11 - 24	51446 ²	51447 ²	BH8
	98 - 09	51332	51333	BH1
Ram 1500 / 2500 / 3500	10 - 10	51438	51439	BH8
	95 - 09	51332	51333	BH1
Ford				
Bronco	21 - 24	51436 ²	51437 ²	BH7
	94 - 96	51322	51323	BH2, BH1
	92 - 93	51312	51313	BH1
E-150	09 - 14	51432	51433	BH5
	03 - 08	51322	51323	BH2, BH1
E-150 Club Wagon	03 - 05	51322	51323	BH2, BH1
E-150 Econoline	92 - 02	51322	51323	BH2, BH1
E-150 Econoline Club Wagon	92 - 02	51322	51323	BH2, BH1
E-250	09 - 14	51432	51433	BH5
E-250 Econoline	92 - 02	51322	51323	BH2, BH1
E-350 Econoline	92 - 98	51322	51323	BH2, BH1
E-350 Econoline Club Wagon	92 - 02	51322	51323	BH2, BH1
E-350 Super Duty	09 - 14	51432	51433	BH5
E-450 Econoline Super Duty	00 - 02	51322	51323	BH2, BH1
E-450 Super Duty	09 - 14	51432	51433	BH5
Excursion	00 - 05	51322	51323	BH2, BH1
Expedition	18 - 20	--	51524	BH4
	15 - 17	51436	51437	BH7
	13 - 14	51432	51433	BH5
	97 - 12	51322	51323	BH2, BH1
Explorer	02 - 20	51322	51323	BH2, BH1
Explorer Sport Trac	07 - 10	51322	51323	BH2, BH1
F-150	09 - 24	51436	51437	BH7
	94 - 08	51322	51323	BH2, BH1
	92 - 93	51312	51313	BH1
F-150 Heritage	04 - 04	51322	51323	BH2, BH1
F-150 Lightning	22 - 24	51436	51437	BH7
F-250	94 - 97	51322	51323	BH2, BH1
F-250 HD	97 - 97	51322	51323	BH2, BH1
F-250 / F-350 Super Duty	17 - 24	51436	51437	BH7
	08 - 16	51432	51433	BH5
	05 - 07	51372	51373	BH4
	99 - 04	51322	51323	BH2, BH1
F-350	94 - 96	51322	51323	BH2, BH1
F-450 / F-50 Super Duty	17 - 24	51436	51437	BH7
	08 - 16	51432	51433	BH5
	05 - 07	51372	51373	BH4
Flex	12 - 20	51436	51437	BH7
	09 - 11	51322	51323	BH2, BH1
Police Interceptor Utility	13 - 18	51322	51323	BH2, BH1

Make / Model (Style)	Years	Bulk #	Pkg #	Loc.
Windstar	95 - 03	51322	51323	BH2, BH1
Genesis				
GV70	22 - 25	--	51529	BH1
GV80	21 - 24	--	51529	BH1
GMC				
Acadia	07 - 18	51422	51423	BH1
Acadia Limited	17 - 17	51422	51423	BH1
Sierra 1500	19 - 25	--	51525	BH1
	14 - 18	51451	51452	BH3, BH1
	03 - 06	51352	51353	BH3
	99 - 02	51342	51343	BH3
Sierra 1500 Classic	07 - 07	51352	51353	BH3
Sierra 1500 HD	03 - 06	51352	51353	BH3
	01 - 02	51342	51343	BH3
Sierra 1500 HD Classic	07 - 07	51352	51353	BH3
Sierra 1500 Limited	22 - 22	--	51525	BH1
	19 - 19	51451	51452	BH3, BH1
Sierra 2500	03 - 04	51352	51353	BH3
	99 - 02	51342	51343	BH3
Sierra 2500 HD	20 - 25	--	51525	BH1
	14 - 19	51451	51452	BH3, BH1
	03 - 06	51352	51353	BH3
	01 - 02	51342	51343	BH3
Sierra 2500 HD Classic	07 - 07	51352	51353	BH3
Sierra 3500	03 - 06	51352	51353	BH3
	01 - 02	51342	51343	BH3
Sierra 3500 Classic	07 - 07	51352	51353	BH3
Sierra 3500 HD	20 - 25	--	51525	BH1
	14 - 19	51451	51452	BH3, BH1
Yukon	21 - 24	--	51525	BH1
	15 - 20	51451	51452	BH3, BH1
	03 - 06	51352	51353	BH3
	00 - 02	51342	51343	BH3
Yukon XL	21 - 24	--	51525	BH1
	15 - 20	51451	51452	BH3, BH1
Yukon XL 1500 / 2500	03 - 06	51352	51353	BH3
	00 - 02	51342	51343	BH3
Honda				
Passport	19 - 25	51392	51393	BH1
Pilot	09 - 25	51392	51393	BH1
Ridgeline	06 - 25	51392	51393	BH1
Hummer				
H2	03 - 07	51352	51353	BH3
Hyundai				
Palisade	21 - 24	--	51529	BH1
Santa Cruz	22 - 24	--	51529	BH1

¹ Excluding factory integrated brake control - ITBC (Ram trucks)

² With factory tow package

*Continued while supplies last

Scan the QR code on page 149 for installation location diagram

Applications continued on the following page

BRAKE CONTROLLER HARNESS APPLICATIONS

Make / Model (Style)	Years	Bulk #	Pkg #	Loc.
Infiniti				
QX56	04 - 13	51382	51383	BH1
QX60	14 - 24	51382	51383	BH1
QX80	14 - 20	51382	51383	BH1
Jeep				
Cherokee	14 - 23	51459	51460	BH1
Gladiator	20 - 24	51527	51526	BH1
Grand Cherokee	11 - 24	51446 ²	51447 ²	BH8
Grand Cherokee L	21 - 24	51446	51447	BH8
Grand Cherokee WK	22 - 22	51446	51447	BH8
Grand Wagoneer	22 - 24	51446	51447	BH8
Wagoneer	22 - 24	51446	51447	BH8
Wrangler	18 - 24	51527	51526	BH1
Kia				
Telluride	21 - 24	--	51529	BH1
Land Rover				
LR3	05 - 09	51322	51323	BH2, BH1
LR4	10 - 16	51322	51323	BH2, BH1
Range Rover	05 - 15	51322	51323	BH2, BH1
Range Rover Evoque	12 - 17	51322	51323	BH2, BH1
Range Rover Sport	06 - 15	51322	51323	BH2, BH1
Lexus				
GX460	10 - 24	51362	51363	BH1
GX470	03 - 09	51362	51363	BH1
LX470	03 - 07	51362	51363	BH1
LX570	13 - 21	51362	51363	BH1
	08 - 11	51362	51363	BH1
LX600	22 - 24	51362	51363	BH1
Lincoln				
Mark LT	06 - 08	51322	51323	BH2, BH1
MKT	12 - 19	51436	51437	BH7
	10 - 11	51322	51323	BH2, BH1
Navigator	15 - 20	51436	51437	BH7
	13 - 14	51432	51433	BH5
	98 - 12	51322	51323	BH2, BH1
Mazda				
CX-50	23 - 24	--	51530	BH2
CX-70	25 - 25	--	51530	BH2
CX-90	24 - 25	--	51530	BH2

Make / Model (Style)	Years	Bulk #	Pkg #	Loc.
Mercury				
Mountaineer	02 - 10	51322	51323	BH2, BH1
Nissan				
Armada	05 - 24	51382	51383	BH1
Frontier	05 - 24	51382	51383	BH1
NV1500 / 2500 / 3500	12 - 21	51382	51383	BH1
NV200	13 - 21	51382	51383	BH1
Pathfinder	05 - 24	51382	51383	BH1
Pathfinder Armada	04 - 04	51382	51383	BH1
TITAN	04 - 24	51382	51383	BH1
TITAN XD	16 - 24	51382	51383	BH1
Xterra	05 - 15	51382	51383	BH1
Ram				
1500	15 - 24	51457 ¹	51458 ¹	BH2
	13 - 14	--	51453	BH8
	11 - 12	51438	51439	BH8
1500 Classic	19 - 24	51457 ¹	51458 ¹	BH2
2500 / 3500	15 - 24	51457 ¹	51458 ¹	BH2
	13 - 14	--	51453	BH8
	11 - 12	51438	51439	BH8
4500 / 5500	16 - 24	51457 ¹	51458 ¹	BH2
Saturn				
Outlook	07 - 10	51422	51423	BH1
Toyota				
4Runner	03 - 22	51362	51363	BH1
Land Cruiser	03 - 21	51362	51363	BH1
Sequoia	03 - 24	51362	51363	BH1
Tacoma	16 - 24	51455	51456	BH4
	07 - 15	51362	51363	BH1
Tundra	15 - 18	51455	51456	BH4
	03 - 14	51362	51363	BH1
Volkswagen				
Atlas	21 - 24	--	51528 ²	BH9
	18 - 20	--	51522 ²	BH2
Atlas Cross Sport	20 - 24	--	51528 ²	BH9
ID.4	21 - 22	--	51528 ²	BH9
Touareg	04 - 17	--	51522	BH2

¹ Excluding factory integrated brake control - ITBC (Ram trucks)

² With factory tow package

*Continued while supplies last

Scan the QR code on page 149 for installation location diagram

BRAKE CONTROLLER REPLACEMENT PARTS

Part #	Description	Fits
19297	Mounting bracket and hardware	51146, 51126, 51116
51186	Echo Security strap	51180
19301	Spectrum Knob	51170

Part #	Description	Fits
51124	Mounting bracket and hardware	51120
51114	Mounting bracket and hardware	51110

Check to ensure battery is charged before towing

- Activates electric trailer brakes in the event of a breakaway
- Meets DOT requirements for holding / breakaway situations
- Compatible on trailers with up to three axles
- LED lights indicate a good charge, battery charging or low battery (#52042, #52044)
- Bolt-on mounting system for secure installation on the trailer
- Required in most states



Part #	Loads From	Includes	Replacement Part #
Push-to-Test Breakaway Kits			
52044	Top	Push-to-test, lockable battery case	--
		12-volt 5-amp rechargeable battery	52023
		Built-in battery charger	--
		Nylon breakaway switch	52010
		Mounting hardware	--
52042	Side	Includes the same parts as 52044	--
Soft-Trac 1 Breakaway Kits			
52040	Side	Lockable battery case	--
		12-volt 5-amp rechargeable battery	52023
		Nylon breakaway switch	52010
		Battery charger	52025
		Mounting hardware	--
52041	Side	Includes the same parts as 52040 Battery charger not included	--
Soft-Trac 2 Breakaway Kits			
52028	Top	Lockable battery case with bracket	52029
		12-volt 5-amp rechargeable battery	52023
		Nylon breakaway switch	52010
		Battery charger	52025
52026	Top	Includes the same parts as 52028 Battery charger not included	--



BE READY FOR ANYTHING WITH A CURT BREAKAWAY

BRAKE CONTROLLERS

BREAKAWAY KIT & BATTERY CASE REPLACEMENT PARTS

- For use with trailer breakaway systems
- Connects tow vehicle to trailer breakaway battery (#52010, #52011)
- Features a high-temp metal mounting tab and nylon pull-pin (#52020)
- Protects battery and charger from the elements and corrosion
- Constructed from durable polyethylene plastic

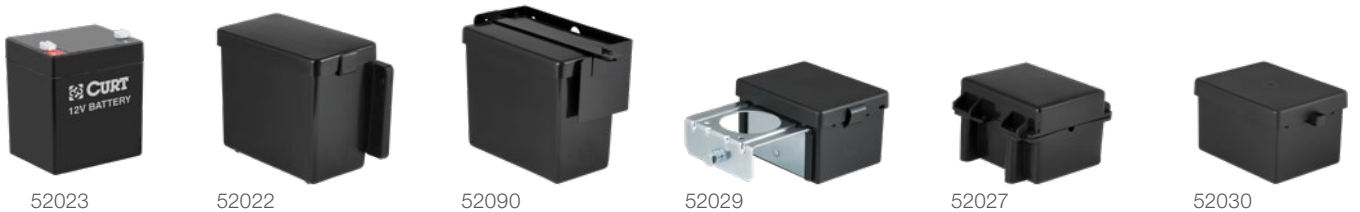

Bulk #	Pkg #	Width	Height	Depth	Description	Loads From	Includes
Breakaway Replacement Parts							
52010	52011	--	--	--	Breakaway switch with 10' leads	--	Nylon case with weldable high-temp, metal tab and silver contact points
52020	52021	--	--	--	48" lanyard	--	--
52023	--	3-1/2"	4"	2-3/4"	Sealed lead acid battery for 1-3 axle trailers (12-volt, 5 amps per hour)	--	--
52025	--	--	--	--	12-volt battery charger plug	--	--
Replacement Battery Cases							
52029	--	5"	3-1/4"	3-7/8"	3-1/8" inside bracket depth	Top	Weldable metal bracket for easy mounting on A-frame or jack posts
52030	--	5"	3-1/4"	3-7/8"	--	Side	--
52027	--	5"	3-3/8"	3-3/4"	Watertight case with rubber gaskets and screw-tight lid	Top	Four-screw lid
52022	--	6"	5-1/2"	3-1/4"	--	Top	Lockable tab and a bolt-on mount
52090	--	5-7/8"	5-3/8"	3-1/2"	--	Top	Metal bracket / locking bar for security



On vehicles with two-wire electrical systems that require a powered converter, the converter's red wire is not used as a stoplight connection and needs to be grounded.

ELECTRICAL CONVERTERS

TAILLIGHT CONVERTERS

ESD - Electrostatic Discharge
PWM - Pulse-Width Modulation
SMT - Surface Mount Technology

For vehicles that are not compatible with CURT custom wiring options, a taillight converter provides a reliable alternative. CURT taillight converters splice into the vehicle's wiring system and provide a standard 4-way flat trailer connector. **Use the application guide on page 32 to find the right wiring solution for your customer.**

ELECTRICAL CONVERTERS

3-TO-2-WIRE TAILLIGHT CONVERTERS

For taillight converter applications go to page 32

- Potted enclosure increases water and vibration resistance for mounting on vehicle exterior (#56496 / #59496)
- Provides improved overvolt, ESD and short-circuit protection (#56496 / #59496)
- No heavy-duty flasher required
- Four snap locks included for fast, secure splicing (excluding #58240)
- Kits contain 10-amp powered converter wiring kit #55151



Kit #	Pkg #	Bulk #	Powered	Circuit-Protected	Signal Circuit	Taillight Circuit	SMT
59496	56496	--	Yes	Yes	3.0 amps	6.0 amps	Yes
--	56130	--	--	--	3.0 amps	5.0 amps	Yes
--	56175	--	--	Yes	3.0 amps	5.0 amps	Yes
59187	56187	--	Yes	--	3.0 amps	5.0 amps	Yes
59190	56190	--	Yes	Yes	7.5 amps	7.5 amps	Yes
--	--	58240 ¹	--	--	2.1 amps	5.0 amps	Yes

¹ Comes with blunt-cut wires instead of 4-way flat output

ELECTRICAL CONVERTERS

MULTI-FUNCTION TAILLIGHT CONVERTER

- Converts 2-wire, 3-wire or PWM systems to 2-wire trailer light wiring
- Potted enclosure significantly increases resistance to water and vibration
- Constructed with SMT circuitry for better performance and durability
- Microcontroller senses current to rapidly react to overload
- Provides improved overload, short-circuit and thermal protection
- Low-voltage operation allows function down to seven volts
- Four snap locks included for fast, secure splicing
- #59236 contains 15-amp powered converter wiring kit #55152



Kit #	Pkg #	Powered	Circuit- Protected	Signal Circuit	Taillight Circuit
59236	56236	Yes	Yes	5.0 amps	7.5 amps

ELECTRICAL CONVERTERS

LOW-SIDE SWITCHING TAILLIGHT CONVERTER

- SMT circuitry for better performance and durability
- Snap locks included for fast, secure splicing
- No heavy-duty flasher required

Part #	Powered	Signal Circuit	Taillight Circuit
56195	Yes	2.1 amps	4.2 amps



56195

ELECTRICAL CONVERTERS

2-TO-3-WIRE TAILLIGHT CONVERTER

- Used for dinghy towing
- Constructed with SMT circuitry for better performance and durability
- No heavy-duty flasher or direct battery connection required
- Not compatible with LED trailer lighting systems

Part #	Powered	Signal Circuit	Taillight Circuit
56196	No	2.1 amps	5.0 amps

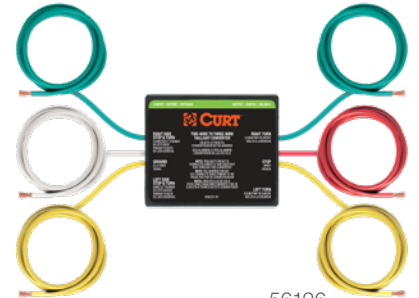

56196

ELECTRICAL CONVERTERS

24-VOLT TAILLIGHT CONVERTER

- Primarily used for 24V automotive systems, buses, trucks and cab and chassis wiring
- 3-wire to 2-wire converter compatible with incandescent and LED trailer lighting systems
- No heavy-duty flasher or direct battery connection required
- Does not reduce output to 12 volts

Part #	Powered	Signal Circuit	Taillight Circuit	Wire Length	Wire Size
56424	No	2.1 amps	7.5 amps	26"	16-gauge



56424

ELECTRICAL CONVERTERS

POWERED TAILLIGHT CONVERTER WIRING KITS

- Routes power from vehicle battery to powered converter



55151

55152

Part #	Includes	Size	Qty
55151 (10-amps)	Cross-linked wire	12-gauge	20 feet
	In-line fuse holder	10-amp (red)	1
	ATC fuse	10-amp (red)	1
	3/8" ring terminal	12-10 gauge	1
	Butt connector	12-10 gauge	2
	Hex head screw	#8 - 1/2"	1
	Cable tie	14-1/2"	1
	Cable ties	6"	8

Part #	Includes	Size	Qty
55152* (15-amps)	Cross-linked wire	12-gauge	20 feet
	In-line fuse holder	15-amp (yellow)	1
	ATC fuse	15-amp (blue)	1
	3/8" ring terminal	12-10 gauge	1
	Butt connector	12-10 gauge	2
	Hex head screw	#8 - 1/2"	1
	Cable tie	14-1/2"	1
	Cable ties	6"	8

*Use with #56236 (page 154)

CUSTOM WIRING

CUSTOM WIRING & T-CONNECTORS

For custom wiring applications go to page 32

Custom wiring is the easiest way to equip a vehicle with a trailer wiring connection. There are two types: harnesses and connectors. Both are made vehicle-specific and install with no cutting or splicing.

- Provides a standard 4-way flat connector on the vehicle for plugging in trailer wiring
- Simple plug-and-play design eliminates the need for cutting or splicing
- Equipped with a taillight converter if needed
- Dust cover included to keep 4-way flat clean when not in use



Harnesses

Custom wiring harnesses use multiple plugs to 'T' into the taillight assembly

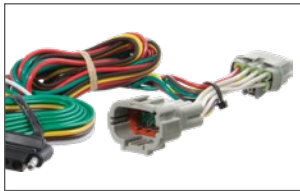

Connectors

Custom wiring connectors use a single plug to plug into a specific OEM socket



CUSTOM WIRING

DODGE FACTORY HARNESS ADAPTER

- Adapts Dodge harness applications to fit USCAR replacement plugs (pictured right)
- Simple plug-and-play design eliminates the need for cutting or splicing
- Slit loom keeps wires contained and well protected



Provides this USCAR socket



57300

Make / Model	Years
Chrysler	
Aspen	07 - 08
Dodge	
Dakota	00 - 09
Durango	01 - 08
Ram 1500	00 - 08
Ram 1500 Van	01 - 03
Ram 2500	00 - 09
Ram 2500 Van	01 - 03

Make / Model	Years
Dodge (continued)	
Ram 3500	00 - 09
Ram 3500 Van	01 - 03
Sprinter 2500	03 - 09
Sprinter 3500	03 - 09
Freightliner	
Sprinter 2500	03 - 09
Sprinter 3500	03 - 09

Make / Model	Years
Jeep	
Commander	06 - 10
Grand Cherokee	00 - 10
Liberty	05 - 08
Mitsubishi	
Raider	06 - 09

#57300 fits all applications listed above
Must be equipped with factory tow package

CUSTOM WIRING

REPLACEMENT USCAR SOCKET

- Replaces damaged or missing USCAR vehicle harnesses
- Retrofits weatherproof USCAR-type 7-way to vehicles not equipped by using CURT part numbers 55415, 55515, 55664, 55774, 56514, 56515 or 57101

Part #	Length	Replaces	Provides
56229	24" wires	Existing vehicle harness connector	USCAR connector end



CUSTOM WIRING

ELECTRICAL ADAPTERS

DUAL-OUTPUT ADAPTERS WITH BACKUP ALARM

- Integrated backup alarm sounds when vehicle is in reverse (97 decibels)
- Provides 7-way RV blade and 4-flat sockets
- Dust covers included to keep connectors clean
- Bracket mounts wiring to the vehicle or trailer hitch



57101 USCAR plug



Pkg #	Fits	Plugs Into	Output
Custom Wiring			
57101	See USCAR replacement products on page 159	USCAR socket	7-way RV blade and 4-way flat
Adapter			
57102	Universal adapter	4-way flat, manual wiring needed	7-way RV blade and 4-way flat

CUSTOM WIRING

OEM DUAL-OUTPUT 7- & 4-WAY SOCKET

- Plugs into USCAR socket to provide 4- and 7-way trailer wiring connectors
- Fits USCAR-equipped vehicles with factory tow plugs only (see page 160 for applications)
- Easy, snap-in installation with simple plug-and-play design eliminates the need for cutting or splicing
- Rubber gasket to keep moisture and elements out
- Spring-loaded dust covers keep connectors clean
- Pre-greased terminals for a reliable connection



All plug into this USCAR socket



Fits USCAR-equipped vehicles with factory tow plugs only



Plugs into USCAR socket to provide 4- and 7-way trailer wiring connectors



Snap-in installation with simple plug-and-play design eliminates cutting or splicing

Bulk #	Pkg #	Kit #	Fits	Plugs Into	Output
57015	57020	57021* N	See USCAR application guide on page 160	USCAR socket	7-way RV blade and 4-way flat

*Includes mounting bracket

ELECTRICAL ADAPTERS

4-WAY FLAT TO USCAR

- Adapts 4-way flat vehicle socket to accept a USCAR connector
- Blunt-cut wires to add reverse lights, trailer brakes and auxiliary power
- Includes wire kit for connecting to vehicle battery
- Some manual wiring required

Part #	From Vehicle	To Trailer	Finish
56476	4-way flat	USCAR socket	Plastic



- Fits USCAR-equipped vehicles with factory tow plugs
- See page 180 for USCAR mounting bracket #58520



All plug into this USCAR socket



Part #	Plugs Into	Provides	Output
55774*	USCAR socket	Two output connections and mounting bracket	7-way RV blade and 4-way flat
57101*	USCAR socket	Two output connections, backup alarm, and mounting bracket	7-way RV blade and 4-way flat
55664*	USCAR socket	Two output connections and mounting bracket	6-way round and 4-way flat
55515	USCAR socket	Replacement end	4-way flat
56515	USCAR socket	Replacement end	5-way flat
55384	T's into USCAR socket	Additional connection	4-way flat
56584	T's into USCAR socket	Additional connection	5-way flat
55416	USCAR socket	Heavy-duty replacement socket	7-way RV blade
55415	USCAR socket	Replacement socket	7-way RV blade
56415	USCAR socket	Replacement for twist-lock brackets	7-way RV blade
56475	USCAR socket	24" extension	USCAR socket

*Includes mounting bracket

USCAR CUSTOM WIRING HARNESSSES & CONNECTORS APPLICATION GUIDE



All plug into this USCAR socket

- To see USCAR products that fit the applications below, go to page 159
- Fits USCAR-equipped vehicles with factory tow plugs
- See page 180 for USCAR mounting bracket #58520

Make / Model	Style	Years
Audi		
Q7	--	17 - 22
Buick		
Enclave	--	08 - 25
Rainier	--	04 - 07
Cadillac		
Escalade	--	02 - 22
Escalade ESV	--	03 - 22
Escalade EXT	--	02 - 13
XT5	--	17 - 25
XT6	--	20 - 25
Chevrolet		
Avalanche	--	07 - 13
Avalanche 1500 / 2500	--	02 - 06
Blazer	AWD	19 - 25
Colorado	--	04 - 24
Equinox	--	18 - 22
Express 1500 / 4500	--	09 - 09
Express 2500 / 3500	--	09 - 24
Silverado 1500	--	99 - 25
Silverado 1500 Classic	--	07 - 07
Silverado 1500 HD	--	01 - 06
Silverado 1500 HD Classic	--	07 - 07
Silverado 1500 LD	--	19 - 19
Silverado 1500 LTD	--	22 - 22
Silverado 2500	--	99 - 04
Silverado 2500 HD	--	01 - 25
Silverado 2500 HD Classic	--	07 - 07
Silverado 3500	--	01 - 06
Silverado 3500 Classic	--	07 - 07
Silverado 3500 HD	--	08 - 25
Suburban	--	15 - 24
Suburban 1500	--	00 - 14
Suburban 2500	--	00 - 13
Suburban 3500 HD	--	16 - 19
Tahoe	--	00 - 24
Trailblazer	--	02 - 09
Trailblazer EXT	--	02 - 06
Traverse	--	09 - 24
Traverse Limited	--	24 - 24
Chrysler		
Aspen	--	07 - 09
Pacifica	--	17 - 22
Voyager	--	20 - 22

Make / Model	Style	Years
Dodge		
Durango	With factory tow pkg	11 - 24
	--	07 - 09
Ram 1500	--	09 - 10
Ram 2500 / 3500	--	10 - 10
Ford		
E-150	--	03 - 10
E-150 Club Wagon	--	03 - 05
E-150 Econoline	--	97 - 02
E-150 Econoline Club Wagon	--	97 - 02
E-250	--	03 - 10
E-250 Econoline	--	97 - 02
E-350 Club Wagon	--	03 - 05
E-350 Econoline	--	97 - 98
E-350 Econoline Club Wagon	--	97 - 02
E-350 Super Duty	--	99 - 10
E-450 Econoline Super Duty	--	00 - 02
E-450 Super Duty	--	03 - 10
Excursion	--	00 - 05
Expedition	--	97 - 24
Explorer	--	00 - 24
Explorer Sport Trac	--	09 - 10
F-150	--	97 - 24
F-150 Heritage	--	04 - 04
F-150 Lightning	--	22 - 24
F-250	--	97 - 99
F-250 HD	--	97 - 97
F-250 Super Duty	--	99 - 24
F-350 Super Duty	--	99 - 24
F-450 Super Duty	--	99 - 24
F-550 Super Duty	--	99 - 24
F-650	--	00 - 24
Flex	--	09 - 16
Police Interceptor Utility	--	18 - 18
Ranger	--	00 - 24
Transit-150	--	15 - 24
Transit-250	--	15 - 24
Transit-350	--	15 - 24
Transit-350 HD	--	15 - 24
Freightliner		
Sprinter 2500	With factory tow pkg	10 - 21
Sprinter 3500	With factory tow pkg	10 - 21

Make / Model	Style	Years
GMC		
Acadia	--	07 - 24
Acadia Limited	--	17 - 17
Canyon	--	04 - 24
Envoy	--	02 - 09
Envoy XL	--	02 - 06
Envoy XUV	--	04 - 05
Savana 1500	--	09 - 09
Savana 2500	--	09 - 24
Savana 3500	--	09 - 24
Savana 4500	--	09 - 09
Sierra 1500	--	99 - 25
Sierra 1500 Classic	--	07 - 07
Sierra 1500 HD	--	01 - 06
Sierra 1500 HD Classic	--	07 - 07
Sierra 1500 Limited	--	19 - 22
Sierra 2500	--	99 - 04
Sierra 2500 HD	--	01 - 25
Sierra 2500 HD Classic	--	07 - 07
Sierra 3500	--	01 - 06
Sierra 3500 Classic	--	07 - 07
Sierra 3500 HD	--	07 - 25
Terrain	--	18 - 24
Yukon	--	00 - 24
Yukon XL	--	15 - 24
Yukon XL 1500	--	00 - 14
Yukon XL 2500	--	00 - 13
Honda		
Passport	--	19 - 24
Pilot	--	09 - 25
Ridgeline	--	06 - 25
Hummer		
H2	--	03 - 09
H3	--	06 - 10
H3T	--	09 - 10
INFINITI		
JX35	--	13 - 13
QX56	--	04 - 13
QX60	--	14 - 24
QX80	--	14 - 24
Isuzu		
Ascender	--	03 - 08
Jeep		
Cherokee	--	14 - 24
Gladiator	--	20 - 24
Grand Cherokee	With factory tow pkg	19 - 24
	Built before May 2018	18 - 18
	--	11 - 17
Grand Cherokee L	--	21 - 24
Grand Cherokee WK	--	22 - 22
Wrangler	JL	18 - 24
	JK	07 - 18

Make / Model	Style	Years
Kia		
Borrego	--	09 - 11
Lexus		
GX460	--	10 - 24
LX570	--	13 - 21
LX600	--	22 - 24
Lincoln		
Aviator	--	03 - 05
Mark LT	--	06 - 08
Navigator	--	98 - 24
Mazda		
CX-70	--	25 - 25
CX-90	--	24 - 25
Mercedes-Benz		
Sprinter 2500	With factory tow pkg	10 - 24
Sprinter 3500	With factory tow pkg	10 - 24
Mercury		
Mountaineer	--	02 - 10
Nissan		
Armada	--	05 - 24
Frontier	--	05 - 24
Pathfinder	--	05 - 24
Pathfinder Armada	--	04 - 04
Titan	--	04 - 24
Titan XD	--	16 - 24
Oldsmobile		
Bravada	--	02 - 04
Ram		
1500	--	11 - 25
1500 Classic	--	19 - 24
2500 / 3500 / 4500 / 5500	--	11 - 24
ProMaster 1500 / 2500 / 3500	--	14 - 24
Saab		
9-7x	--	05 - 09
Saturn		
Outlook	--	07 - 10
Subaru		
Ascent	--	19 - 24
Toyota		
4Runner	--	15 - 24
Land Cruiser	--	18 - 22
Sequoia	--	12 - 24
Tacoma	--	07 - 24
Tundra	--	10 - 24
Volkswagen		
Atlas	With factory tow pkg	21 - 24
Atlas Cross Sport	With factory tow pkg	20 - 24



7' with GM cover plate

ROUTES SOCKET INTO REAR OF THE TRUCK BED

**CUSTOM
WIRING**

CUSTOM WIRING HARNESS EXTENSIONS

For harness applications
see adjacent page

- Routes a 7-way RV blade socket into truck bed while retaining use of rear socket
- Simple plug-and-play design eliminates the need for cutting or splicing
- Allows for easy connection of 5th wheel or gooseneck wiring
- 7' extension with right-angle plug for easy installation
- Spring-loaded dust cover keeps connector clean when not in use
- Slit loom keeps wires contained and well protected
- Requires 2-1/8" hole saw for installation



56071 (7') / 56001 (10')



56070 (7') / 56000 (10')



10' routes socket closer to truck cab

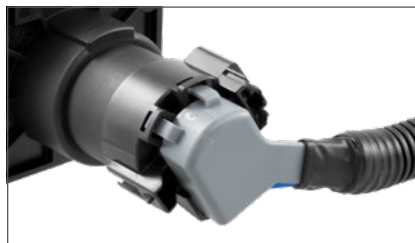

Right-angle plug for easy installation



#57015 4- and 7-way dual socket

Make / Model	Style	Years	7' Pkg#	Includes #	7' Bulk 10-Pack#	10' Pkg#	Includes #	10' Bulk 10-Pack#
Chevrolet / GMC								
Silverado / Sierra 1500	--	19 - 25	56003	57015 ³	--	--	--	--
			56072	55417 ²	--	--	--	--
		99 - 18	56070	--	56070010	56000	--	56000010
Silverado / Sierra 1500 Classic	--	07 - 07	56070	--	56070010	56000	--	56000010
Silverado / Sierra 1500 HD	--	01 - 06	56070	--	56070010	56000	--	56000010
Silverado / Sierra 1500 HD Classic	--	07 - 07	56070	--	56070010	56000	--	56000010
Silverado 1500 LD	--	19 - 19	56070	--	56070010	56000	--	56000010
Silverado 1500 LTD	--	22 - 22	56003	57015 ³	--	--	--	--
			56072	55417 ²	--	--	--	--
		19 - 19	56070	--	56070010	56000	--	56000010
Sierra 1500 Limited	--	22 - 22	56003	57015 ³	--	--	--	--
			56072	55417 ²	--	--	--	--
		19 - 19	56070	--	56070010	56000	--	56000010
Silverado / Sierra 2500	--	99 - 04	56070	--	56070010	56000	--	56000010
Silverado / Sierra 2500 HD	--	20 - 25	56003	57015 ³	--	--	--	--
			56072	55417 ²	--	--	--	--
		01 - 19	56070	--	56070010	56000	--	56000010
Silverado / Sierra 2500 HD Classic	--	07 - 07	56070	--	56070010	56000	--	56000010
Silverado / Sierra 3500	--	01 - 06	56070	--	56070010	56000	--	56000010
Silverado / Sierra 3500 Classic	--	07 - 07	56070	--	56070010	56000	--	56000010
Silverado / Sierra 3500 HD	--	20 - 25	56003	57015 ³	--	--	--	--
			56072	55417 ²	--	--	--	--
		07 - 19	56070	--	56070010	56000	--	56000010
Dodge								
Dakota	--	95 - 10	56071	--	--	56001	--	--
Ram 1500	--	09 - 10	56070	--	56070010	56000	--	56000010
		95 - 08	56071	--	--	56001	--	--
Ram 2500 / 3500	--	10 - 10	56070	--	56070010	56000	--	56000010
		95 - 09	56071	--	--	56001	--	--
Ford								
F-150	--	15 - 24	57008	57007 ¹	--	57010	57007 ¹	--
		97 - 14	56070	--	56070010	56000	--	56000010
F-150 Heritage	--	04 - 04	56070	--	56070010	56000	--	56000010
F-250	--	97 - 99	56070	--	56070010	56000	--	56000010
F-250 HD	--	97 - 97	56070	--	56070010	--	--	--
F-250 Super Duty	--	17 - 24	57008	57007 ¹	--	57010	57007 ¹	--
		99 - 16	56070	--	56070010	56000	--	56000010
F-350 / F-450 Super Duty	Excluding Cab & Chassis	17 - 24	57008	57007 ¹	--	57010	57007 ¹	--
		99 - 16	56070	--	56070010	56000	--	56000010
	Cab & Chassis with 34" frame	99 - 24	56070	--	56070010	56000	--	56000010
F-550 Super Duty	--	99 - 24	56070	--	56070010	56000	--	56000010
Nissan								
Titan	--	04 - 24	56070	--	56070010	56000	--	56000010
Titan XD	--	16 - 24	56070	--	56070010	56000	--	56000010
Ram								
1500	--	11 - 25	56070	--	56070010	56000	--	56000010
1500 Classic	--	19 - 24	56070	--	56070010	56000	--	56000010
2500 / 3500	--	11 - 24	56070	--	56070010	56000	--	--
Toyota								
Tundra	--	10 - 24	56070	--	56070010	56000	--	56000010

¹ 57007 isolator kit to prevent corrosion of aluminum bodies (see page 164)

² 55417 Chevrolet / GMC truck bed cover to provide a clean, factory look (see page 164)

³ 57015 dual-output 7-way & 4-flat connector (see page 164)

CUSTOM WIRING HARNESS EXTENSION ISOLATOR KIT

- Neoprene well nuts isolate steel bolts from aluminum surfaces
- Securely mounts a 7-way RV blade extension harness in the truck bed
- Designed for specific Ford applications

Make / Model	Years	Part #
Ford		
F-150	15 - 24	57007
F-250 / F-350 Super Duty	17 - 24	57007

GM TRUCK BED 7-WAY OPENING COVER PLATE

- Covers gaps to provide a clean, factory look in the truck bed
- Easy, snap-in installation
- Slotted holes for adjustability
- Compatible with spray-in liners



Part #	Adapts
55417	CURT 7-way sockets to fit 2020+ factory Chevrolet / GMC truck bed connector openings

OEM REPLACEMENT DUAL-OUTPUT 7- & 4-WAY CONNECTOR

- Plugs into USCAR socket to provide 4- and 7-way trailer wiring connectors
- Fits USCAR-equipped vehicles with factory tow plugs only (see page 160 for applications)
- Easy, snap-in installation with simple plug-and-play design eliminates the need for cutting or splicing
- Rubber gasket to keep moisture and elements out
- Spring-loaded dust covers keep connectors clean
- Pre-greased terminals for a reliable connection



Plugs into this USCAR socket



Bulk #	Pkg #	Kit #	Fits	Plugs Into	Output
57015	57020	57021* N	See USCAR application guide on page 160	USCAR socket	7-way RV blade and 4-way flat

*Includes mounting bracket

PLUGS & SOCKETS

7-WAY RV BLADE EXTENSION

- Routes existing 7-way RV blade socket into full-size pickup truck bed
- Universal size fits any 7-way RV blade socket
- Allows for easy connection of 5th wheel or gooseneck wiring
- 7' extension length accommodates virtually any size truck bed
- Spring-loaded dust cover keeps connector clean when not in use

Part #	Length	Fits
56080	7'	7-way RV blade socket



PLUGS & SOCKETS

7-WAY RV BLADE REPLACEMENT HARNESSES

- Replaces the trailer-end plug of any 7-way harness
- Interchangeable with other 7-way RV blade connectors
- Color-coded wires for easier splicing
- Wires protected by heavy-duty, weather-resistant cable



56601

56621



56602

56622



56603

56623

Bulk #	Pkg #	Length
56601	56621	6'
56602	56622	8'
56603	56623	10'

PLUGS & SOCKETS

COLD-WEATHER 7-WAY RV BLADE REPLACEMENT HARNESSES

- Replaces the trailer-end plug of any 7-way harness
- Soft thermoplastic elastomer casing to remain flexible in cold temperatures (temperature rating from -40°F up to 221°F)
- Interchangeable with other 7-way RV blade connectors
- Color-coded wires for easier splicing



56611



56612



56613

Bulk #	Length
56611	6'
56612	8'
56613	10'



STOP DAMAGE BEFORE IT HAPPENS

CUSTOM WIRING

PROTECTIVE MULTIPRO™ / MULTI-FLEX™ TAILGATE SENSORS

- Prevents deployment of inner tailgate panel when ball mount is installed
- Helps avoid costly tailgate damage
- Compatible with GMC MultiPro™ and Chevrolet Multi-Flex™ tailgates
- Easy installation requires no wire cutting or splicing
- No extra electronic components or batteries required
- Sleek, durable design suited for all work conditions
- Does not interfere with trailer or towing accessories



58267



58268



Prevents deployment of inner tailgate panel when ball mount is installed



Helps avoid costly tailgate damage



Sleek, durable design suited for all work conditions

Part #	Fits Receiver Size	Includes
58267	2"	Sensor cap and wiring harness
58268	2-1/2"	Sensor cap and wiring harness

**RV
HARNESSES**

RV HARNESSES

For RV harness application guide see page 248

- Integrated block diodes isolate sensitive vehicle electronics from RV signals
- Uses towed vehicle's existing taillights, brake lights and turn signals
- Optional harness add-on equips vehicle with standard 4-way flat for towing a trailer (not available for all RV harnesses; see app guide)



Connects a towed vehicle to an RV using a standard 4-way flat trailer plug



Simple plug-and-play design eliminates the need for cutting or splicing



Includes harness, 4-flat extension, mounting bracket and hardware

**RV
HARNESSES**

SPLICE-IN RV HARNESS

- Connects a towed vehicle to an RV using a standard 4-way flat trailer plug
- Splices into vehicle's electrical system with included butt connectors
- Color-coded wires with wiring guide for easier installation
- Integrated block diodes isolate sensitive vehicle electronics from RV signals
- Uses towed vehicle's existing taillights, brake lights and turn signals
- Not compatible with PWM electrical systems



Part #	Description
58979	Splice-in RV harness

**RV
HARNESSES**

RV HARNESS DIODE KIT

- Allows RV to power lights only on the towed vehicle without power feeding back
- Requires trailer-side 4-way flat plug with 20' wires or similar

Part #	Amps / Block	Volts / Block	Includes
58999	3 amps	24 volts max	Four diode blocks / 12 spade terminals



- Allows a standard 4-way flat to connect to other trailer plug types
- Informative, full-color retail packaging



57187



56476



57186



57183



57184

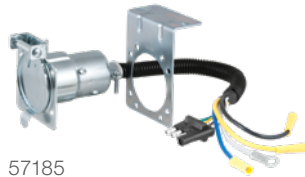

57185



57626



57676



57604



57624



57672



57674



57102

Part #	From Vehicle	To Trailer	Notes	Material
Single Output				
57184	4-way flat	7-way RV blade	See mounting brackets on pages 179 and 180	Plastic
57183	4-way flat	6-way round	See mounting brackets on pages 179 and 180	Die-cast
57185	4-way flat	7-way RV blade	Includes mounting bracket	Steel
57186	4-way flat	7-way RV blade	Includes wiring and components to splice in a brake controller connection	Plastic
57187	4-way flat	5-way flat	Ideal for towing a boat trailer with surge brakes	Plastic
57626 ^{1*}	4-way flat	6-way round	Integrated test lamps display proper connections	Plastic
57676 ¹	4-way flat	7-way RV blade	Integrated test lamps display proper connections	Plastic
56476	4-way flat	USCAR socket	Pair with #57015 for 4-way and 7-way RV blade output. See page 164	Plastic
Dual Output				
57604 ¹	4-way flat	4-way flat 6-way round	--	Plastic
57624 ^{1*}	4-way flat	4-way flat 6-way round	Integrated test lamps display proper connections	Plastic
57672 ¹	4-way flat	4-way flat 7-way RV blade	--	Plastic
57674 ¹	4-way flat	4-way flat 7-way RV blade	Integrated test lamps display proper connections	Plastic
57102 ¹	4-way flat	4-way flat 7-way RV blade	Audible back-up alarm when vehicle in reverse (97 decibels)	Plastic

¹ Includes mounting bracket and hardware

* Continued while supplies last



A SMARTER, QUICKER WAY TO CONNECT YOUR TRAILER

**ELECTRICAL
ADAPTERS**

MAGNETIC 4-WAY FLAT

NEW

- Quickly and easily converts your existing 4-way flat into a magnetic quick-snap connection
- Durable black plastic housing with embedded magnets
- Innovative design makes trailer wiring hookup faster and easier than ever
- No cutting or splicing required
- Flat connection surface is easy to wipe clean as needed, unlike traditional pins
- No pockets, crevasses or holes for debris to accumulate
- Magnetic head with cap allows for convenient stick-on storage when not in use
- Corrosion-resistant connection points for consistent power flow



58306



500-hour salt-spray-tested and vibration-tested for reliable power



Powerful magnets and interlocking, twist-snap action provide a reliable connection every time



Plug-and-play design makes it easier than ever to install. No splicing or cutting required

Part #	Description	Material
58306 N	4-way flat magnetic connector	Plastic

ELECTRICAL ADAPTERS

4-WAY ROUND

- Adapts a 4-way round vehicle socket to fit 4-way flat trailer plugs
- Simple plug-and-play design eliminates the need for cutting or splicing



Bulk #	Pkg #	From Vehicle	To Trailer	Material
58414	--	4-way round	4-way flat	Plastic
57224	57225	4-way round	4-way flat	Plastic
57444*	--	4-way round	4-way flat	Die-cast

* Continued while supplies last

ELECTRICAL ADAPTERS

6-WAY ROUND

- Allows a standard 6-way round to connect to other trailer plug types
- Simple plug-and-play design eliminates the need for cutting or splicing



Bulk #	Pkg #	From Vehicle	To Trailer	Center Pin Function	Material
57620	57621	6-way round	4-way flat	--	Plastic
--	57667	6-way round	7-way RV blade	Taillights	Die-cast and plastic

ELECTRICAL ADAPTERS

6- OR 7-WAY WITH LED DUST COVERS

- LED tester confirms proper function of vehicle-side wiring connector
- Dust cover keeps connector clean when not in use
- Simple plug-and-play design eliminates the need for cutting or splicing



57627



57245



57255



57265

Part #	From Vehicle	To Trailer	Center Pin Function
57627	6-way round	4-way flat	--
57245	7-way RV blade	4-way flat	--
57255	7-way RV blade	6-way round	Auxiliary power
57265*	7-way RV blade	6-way round	Brake lights



57265 LED cover

* Continued while supplies last

ELECTRICAL ADAPTERS

7-WAY RV BLADE FOR LED TRAILER LIGHTS

Did you know?

These adapters are designed for vehicles with a lamp-out indicator. When towing a trailer with LED taillights, the low electrical draw of the LEDs will trigger the indicator. These adapters allow the vehicle to recognize the LED taillights and function normally.

- Allows a 7-way RV blade to connect to other trailer plug types
- Enables vehicles with a 7-way RV blade socket to recognize LED trailer lights
- Built-in, integrated resistors for computers that do not recognize LED lights
- Simple plug-and-play design eliminates the need for cutting or splicing



57004



57005



57003

Part #	From Vehicle	To Trailer	Material
57003	7-way RV blade	7-way RV blade	Plastic
57004	7-way RV blade	4-way flat 5-way flat	Plastic
57005	7-way RV blade	6-way round	Plastic

ELECTRICAL ADAPTERS

7-WAY RV BLADE AND ROUND

- Simple plug-and-play design eliminates the need for cutting or splicing



57240



57250



57260



57660



57241



57251



57261



57661

Bulk #	Pkg #	From Vehicle	To Trailer	Center Pin Function
57240	57241	7-way RV blade	4-way flat	--
57250	57251	7-way RV blade	5-way flat	--
57260	57261	7-way RV blade	6-way round	Auxiliary power
57660	57661	7-way RV blade	6-way round	Brake lights
57040	57041	7-way round	4-way flat	--



57040



57041

ELECTRICAL ADAPTERS

7-WAY RV BLADE WITH BACKUP ALARM OPTION

- Allows a 7-way RV blade to connect to other trailer plug types
- Integrated backup alarm sounds when vehicle is in reverse (97 decibels)
- Simple plug-and-play design eliminates the need for cutting or splicing



57724



57726



57727

Part #	From Vehicle	To Trailer	Center Pin Function
57724	7-way RV blade	4-way flat	--
57726	7-way RV blade	6-way round	Auxiliary power
57727	7-way RV blade	7-way RV blade (extender)	--

DINGHY TOWING ADAPTER HARNESSSES

- Plugs into CURT RV harness 4-flat to provide a standard connector under the dinghy vehicle's hood
- Allows for flexible mounting on the front of the dinghy vehicle versus welded connector bracket
- 6' length is ideal for equipping dinghy vehicle for flat towing behind RV
- Some manual wiring required



58980



58981

Part #	From Dinghy Vehicle	To RV	Length	Material
58980	4-way flat	7-way RV blade	6 feet	Plastic
58981	4-way flat	6-way round	6 feet	Plastic

ELECTRICAL ADAPTERS

DINGHY TOWING ADAPTERS

- Ideal for connecting motorhomes to dinghy vehicle for flat towing
- UV-resistant coiled cable extends without scraping the ground
- Simple plug-and-play design eliminates the need for cutting or splicing
- Constructed from die-cast or durable plastic
- Informative, full-color, retail packaging



57271



57280



57281



57282



57283



57284



57285



57286

Part #	From Dinghy Vehicle	To RV	Extends	Included Socket	Socket Housing
57271	4-way flat	7-way RV blade	5 feet	--	Plastic
57280	4-way flat	7-way RV blade	8 feet	--	Plastic
57281	5-way flat	7-way RV blade	5 feet	--	Plastic
57282	5-way flat	7-way RV blade	8 feet	--	Plastic
57283	6-way round	7-way RV blade	8 feet	One 6-way round	Plastic and die cast
57284	7-way RV blade	7-way RV blade	8 feet	One USCAR 7-way RV blade	Plastic
57285	4-way round	7-way RV blade	8 feet	One 4-way round	Plastic and die cast
57286	6-way round	6-way round	8 feet	Two 6-way round	Die cast

4-WAY FLAT

- Splices into existing wiring to supply power from the vehicle to the trailer
- Looped wires can also be used as a wire extension for an existing connector
- Constructed with 16-gauge bonded wires and durable molded rubber
- Operates on a two-wire system



58030

58031



58380

58381



58033



58032

58348



58349



58040

58041



58044



58345



58304



58344



58042

58355



58305



58050

58051

Bulk #	Pkg #	Pkg Kit#	Location	Wire Length	Description
58030	58031	58033 ¹	Trailer	12"	Plug with bonded wire
58032	58348	58349 ¹	Trailer	48"	Plug with bonded wire
58040	58041	58044 ¹	Vehicle	60"	Socket with bonded wire
--	58304	58344 ¹	Vehicle	12"	Socket with bonded wire
			Trailer	12"	Plug with bonded wire
58042	58355	58305 ^{1*}	Vehicle	48"	Socket with bonded wire
			Trailer	12"	Plug with bonded wire
58050	58051	--	Vehicle	72"	Socket with bonded loop
			Trailer		Plug with bonded loop
58380	58381	--	Vehicle	12"	Socket with bonded loop
			Trailer		Plug with bonded loop
--	57220	--	Trailer	20 feet	Plug with bonded wire



57220

¹ Includes snap locks and hardware (varies by part number)

² Includes snap locks, hardware and mounting bracket

* Continued while supplies last

PLUGS & SOCKETS

2-WAY FLAT

- Splices into existing wiring to supply power to an electrical accessory
- 18-gauge looped wire can also be used as an extension for an existing connector
- Constructed with bonded wires and durable molded rubber

Bulk #	Pkg #	Location	Wire Length	Description
58020	58021	Vehicle Trailer	12"	Socket with bonded loop Plug with bonded loop



PLUGS & SOCKETS

4-WAY FLAT LICENSE PLATE LIGHT PLUGS

- 1-1/4" plug fits a typical license plate light hole
- Includes dust cover
- Constructed with durable molded rubber
- Refer to state and local laws before removing license plate light



Bulk #	Pkg #	Location	Wire Length	Description
58404	57404	Vehicle Trailer	--	Adapter
58405	57405	Vehicle	36"	Socket with bonded wire

PLUGS & SOCKETS

4- & 5-WAY FLAT DUST COVERS

- Protects connector from water, dust and road grime when not in use
- Helps prevent internal corrosion for a long life
- Attachment loop allows for fast, easy installation
- Constructed from durable molded rubber



Bulk #	Pkg #	Location	Material	Fits
58200	58201	Vehicle	Rubber	4-way flat
58750	--	Trailer	Rubber	4-way flat
--	58761	Vehicle Trailer	Rubber	4-way flat
58202	58203	Vehicle	Rubber	5-way flat

PLUGS & SOCKETS

5-WAY FLAT

- Ideal for trailers with surge brakes, commonly found on larger boat trailers
- Splices into existing wiring to supply power from the vehicle to the trailer
- Looped wires can also be used as a wire extension for an existing connector
- Constructed with 16-gauge wires and durable molded rubber



Bulk #	Pkg #	Location	Wire Length	Description
58530	58531	Vehicle	60"	Socket with wire
58540	58541	Trailer	48"	Plug with wire
58550	58551	Vehicle Trailer	72"	Socket with loop Plug with loop

PLUGS & SOCKETS

4-WAY ROUND

- Splices into existing wiring to supply power from the vehicle to the trailer
- Concealed terminals help ensure a reliable connection
- Constructed from strong die-cast metal
- Dust- and water-resistant design to withstand the elements



Bulk #	Pkg #	Pkg Kit#	Location	Material	Description
58060	58061	--	Trailer	Die-cast	Round plug
58070	58071	--	Vehicle	Die-cast	Round socket
--	58671	58677 ¹	Trailer Vehicle	Die-cast Die-cast	Round plug (58060) Round socket (58070)

¹ Includes mounting bracket, wiring and hardware

PLUGS & SOCKETS

6-WAY ROUND

- Splices into existing wiring to supply power from the vehicle to the trailer
- Concealed terminals help ensure a reliable connection
- Spring-loaded dust covers keep connectors clean when not in use



58120



58082



58083



58093



58130



58080



58081



58092



58090

58091

Bulk #	Pkg #	Pkg Kit #	Location	Material	Description
58080	58081	--	Trailer	Die-cast	Round plug
58120	--	--	Trailer	Chrome plastic	Round plug
58082	58083	--	Trailer	Die-cast	Round plug with spring
58090	58091	--	Vehicle	Die-cast	Round socket
58130	--	--	Vehicle	Plastic	Round socket
--	58092	58093 ¹	Trailer	Die-cast	Round plug (58080)
			Vehicle	Die-cast	Round socket (58090)

¹ Kit includes five snap locks, mounting bracket and hardware

PLUGS & SOCKETS

6-WAY SQUARE

- 6-way square connectors are commonly used on popup campers
- Splices into existing wiring to supply power from the vehicle to the trailer
- Looped wires can also be used as a wire extension for an existing connector

Part #	Location	Wire Length	Description
58034	Vehicle Trailer	12"	Square socket with loop Square plug with loop
58035*	Vehicle	12"	Square socket with wire

* Continued while supplies last



58034



58035

PLUGS & SOCKETS

7-WAY ROUND

- 7-way round connectors are commonly used on semi- and utility trailers
- Splices into existing wiring to supply power from the vehicle to the trailer
- Constructed from strong die-cast metal



58170



58160



58161



58180

58181

Bulk #	Pkg #	Location	Material	Description
58170	--	Vehicle	Die-cast	Round socket
58160	58161	Trailer	Die-cast	Round plug
58180	58181	Trailer	Die-cast	Round plug with spring

PLUGS & SOCKETS

7-WAY RV BLADE

- Concealed terminals help ensure a reliable connection
- Ergonomic design offers a comfortable, more secure grip (#58145)
- Weather-resistant dust cover features a rubber insert to seal out moisture (#58155)



58140



58141



58145



58155



58190



58220



58150



58151

58417



58152

Bulk #	Pkg #	Pkg Kit#	Location	Material	Description
58140	58141	--	Trailer	Plastic	RV blade plug
--	58145	--	Trailer	Plastic	Heavy-duty RV blade plug
58150	58151	--	Vehicle	Plastic	RV blade socket
--	58155	--	Vehicle	Plastic	Heavy-duty RV blade socket
58190	--	--	Trailer	Die-cast	RV blade plug
58220	--	--	Vehicle	Steel	RV blade socket
--	58417	--	Vehicle	Plastic	RV blade socket with mounting bracket
--	--	58152 ¹	Trailer Vehicle	Plastic Plastic	RV blade plug RV blade socket

¹ Kit includes six snap locks, mounting bracket and hardware

For USCAR applications, see page 160

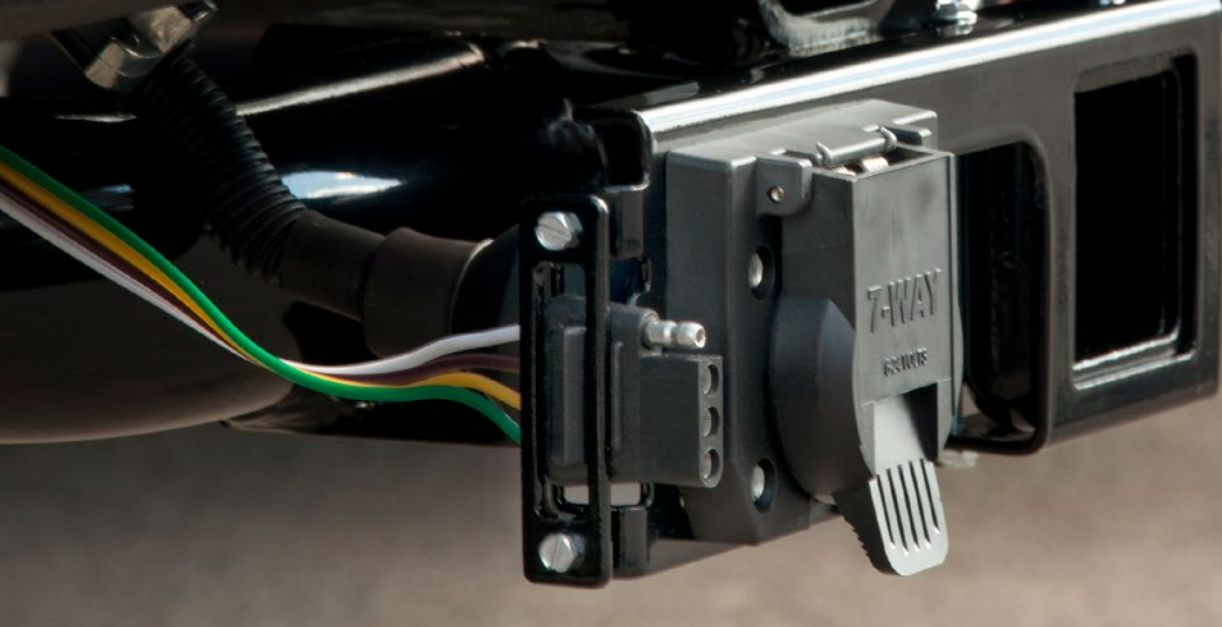

PATENTED. NO-DRILL. HITCH-MOUNTED DESIGN.

PLUGS & SOCKETS

EASY-MOUNT™ ELECTRICAL BRACKETS

- Allows connectors to be hitch-mounted with no drilling or clamping required
- Two threaded stainless steel bolts provide secure attachment to the hitch
- Notched design allows convenient access to pin & clip
- Steel body will not break like competitive plastic products
- Protected by a durable powder coat finish
- Bulk retail boxes contain 10 poly-bagged units
- Patent #9,016,707



Slotted holes to fit multiple connector types (varies by part number, see table below)



Part #	Bulk Retail 10-Pack#	Receiver Tube Opening	Holds
58002	58002010*	1-1/4" x 1-1/4"	4- or 5-way flat sockets
58001	58001010	2" x 2"	4- or 5-way flat sockets
58000	58000010	2" x 2"	4- or 5-way flat and 6- or 7-way sockets
58003	--	2-1/2" x 2-1/2"	4- or 5-way flat and 6- or 7-way sockets

* Continued while supplies last

58001010
10-pack



ELECTRICAL SOCKET MOUNTING BRACKETS

- Allows for secure connector attachment to the vehicle or trailer hitch
- Steel body will not break like competitive plastic products
- Mounting hardware not included (excluding #58303, #57016)



Bulk #	Bulk 12-Pack #	Pkg #	Fits	Description	Finish
For 4-Way Flat, 5-Way Flat and 6-Way Round Connectors					
58300	--	58301	4-way flat	--	Gloss black
--	--	58303	5-way flat	--	Carbide black
--	57207*	57208	4- or 6-way round sockets	--	Gloss black
58210	--	--	4- or 6-way round sockets	--	Zinc-plated
For 7-Way Round and 7-Way RV Blade Connectors					
58222	--	--	7-way round socket #58170	--	Zinc-plated
--	57205	57206	7-way RV blade socket #55415, #58150, #58220	Increased strength	Gloss black
58230	--	58231	7-way RV blade sockets #58150 and #58220	--	Zinc-plated
58290	--	58291	7-way RV blade sockets #58150 and #58220	--	Gloss black
58510	--	--	7-way RV blade sockets #58150 and #58220	Increased strength	Gloss black
58520	--	--	7-way USCAR factory Ford, GM, and Nissan sockets	--	Gloss black
--	--	57016	7-way and 4-way USCAR sockets #57015 and #57020	--	Gloss black
For Mounting Connector Brackets to Trailer Hitches					
--	57203	57204	4- or 5-way flat and 6-way round brackets	Short, universal clamp-on mount	Gloss black
--	57201	57202	7-way round or RV blade sockets	Long, universal clamp-on mount	Gloss black

* Continued while supplies last

ACCESSORIES & TESTERS

LENSES & COMBO LIGHTS

- Exceeds DOT requirements for stop, tail, rear and side reflectors, side markers and license plate illumination
- Two extra hookups provide for other lights
- Molded housing with standard red lenses
- Phosphor-bronze contacts for good connection in any weather
- Bolt-on mounting system for secure installation on the trailer



Part #	Vehicle Side	Lens Color	License Plate Illumination
53440	Passenger	Red	No
53441	Driver	Red	Yes
53445	Rear replacement lens		
53515	Side replacement lens		

ACCESSORIES & TESTERS

TRAILER LIGHT KIT

- Exceeds DOT highway standards
- Designed to replace all necessary trailer lights on most trailers
- Easily connects to any standard automobile lighting system
- Frame mounting clips keep wires contained and protected
- Ideal for trailers up to 80" wide



Part #	Length	Plug	Includes
53540	20'	4- flat	Two combination lights, two marker lights, license plate bracket and frame mounting clips

ACCESSORIES & TESTERS

TOWING LIGHTS

- Easily adds tow lights to a dinghy-towed vehicle or trailer without lights
- Non-scratch magnetic base protects vehicle finish
- Perfect for boats, RVs and flat towing applications
- 20' cord with 4-way flat plug allows for plug-and-play convenience
- Snap locks included for simple, secure splice-in connection
- Patent# D355,270

Bulk #	Pkg #	Length	Plug	Description
53200	53204 ¹	20'	4-way flat	Auxiliary towing lights

¹ Includes a sturdy, reusable case



ACCESSORIES & TESTERS

CONNECTOR TESTERS

- Confirms proper function of vehicle-side wiring connector
- Constructed with LED lights for long-lasting use
- Integrated resistors for compatibility with Smart Trailer Tow Connection™ (#58272, #58273)
- Patent #12,117,477 (#58272, #58273)



58260



57505



58650



58272



58273

Bulk #	Pkg #	Description	Material
58260	58261	LED 4-way flat	Plastic
57505	--	LED 5-way flat	Plastic
58650	--	LED 6-way round	Plastic
58272 ¹	58273 ¹	LED 7-way RV blade	--

¹ Integrated resistors compatible with Smart Trailer Tow Connection



Color-coded LEDs to easily distinguish each vehicle signal (#58272, #58273)

ACCESSORIES & TESTERS

BRAKE CONTROLLER TESTER

- Designed to bench test a brake controller for proper function
- Tests brake voltage, pedal activation, short-circuit / overload and disconnect



51521

Bulk #	Tests	Plug	Socket
51521*	Brake controller unit	--	Quick plug

* Continued while supplies last

ACCESSORIES & TESTERS

BONDED 4-WIRE TRAILER WIRING

- Standard 4-way wire for rewiring a trailer or a similar application



57001

Part #	Gauge	Length	Description
57001	16	25'	Bonded four-wire spool (green, yellow, brown, white)



DURABLE, COLOR-CODED TRAILER WIRE

ACCESSORIES
& TESTERS

TRAILER WIRING SPOOLS

NEW

- Ensure flawless trailer connectivity with CURT automotive primary wire
- Suitable for trailer rewiring and towing electrical repair



57032



57033



57034



57035



57036



57037

Part #	Length	Style	# of Wires	Gauge	Wire color
57030 N	100'	Jacketed	7	10, 12	12-gauge (red / brown / yellow / green / black / blue), 10-gauge (white)
57031 N	250'	Jacketed	7	12, 14	12-gauge (white / black / blue), 14-gauge (red / green / brown / yellow)
57032 N	250'	Bonded	4	16	Green, yellow, brown, white
57033 N	250'	Bonded	2	12	Blue / black
57034 N	500'	Single	1	12	Black
57035 N	500'	Single	1	12	White
57036 N	500'	Single	1	12	Blue
57037 N	500'	Single	1	12	Red
57038 N	250'	Jacketed	2	12	Blue / black

**ACCESSORIES
& TESTERS**

SNAP LOCKS & WIRE NUTS

- Instantly splices two wires together using only a pliers
- Aluminum blade pierces both channels to eliminate any stripping or soldering
- Latching safety lock ensures a reliable connection
- Side gap allows for easy insertion of existing wire
- Constructed from high-impact plastic to protect against corrosion



Bulk #	Gauge	Description	Quantity
58280	18-14	Tap connector	100
59906	18-14	Double-run tap connector	100
59956	18-14	Tap connector with gel sealant	100
59905	12-10	Tap connector	100
59901	18-10	Wire nut	100

**ACCESSORIES
& TESTERS**

RING & SPADE TERMINALS

- Fastens wires down for a firm connection
- Perfect for installing towing electrical components or similar applications
- Vinyl-insulated to ensure a long-lasting connection
- Flared opening allows for easy wire insertion

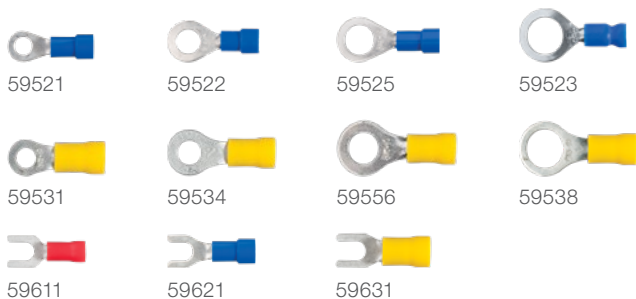

Bulk #	Gauge	Stud Size	Color	Quantity
Ring Terminals				
59521	16-14	#10	Blue	100
59522	16-14	1/4"	Blue	100
59525	16-14	5/16"	Blue	100
59523	16-14	3/8"	Blue	100
59531	12-10	#10	Yellow	100
59534	12-10	1/4"	Yellow	100
59556	12-10	5/16"	Yellow	100
59538	12-10	3/8"	Yellow	100
Spade Terminals				
59611	22-18	#10	Red	100
59621	16-14	#10	Blue	100
59631	12-10	#10	Yellow	100

**ACCESSORIES
& TESTERS**

BUTT & QUICK CONNECTORS

- Quick connectors provide a firm wire connection with the option to disconnect later
- Butt connectors splice wires together with no taping required
- Perfect for installing towing electrical components or similar applications
- Vinyl-insulated to ensure a long-lasting connection
- Flared opening allows for easy wire insertion

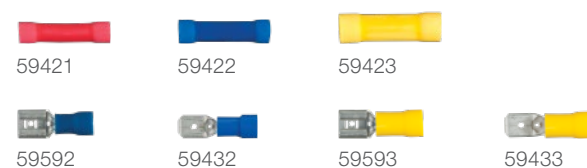

Bulk #	End	Gauge	Color	Quantity
Butt Connectors				
59421	--	22-18	Red	100
59422	--	16-14	Blue	100
59423	--	12-10	Yellow	100
Quick Connectors				
59592	Female	16-14	Blue	100
59432	Male	16-14	Blue	100
59593	Female	12-10	Yellow	100
59433	Male	12-10	Yellow	100

**ACCESSORIES
& TESTERS**

HEAVY-DUTY FLASHERS, CIRCUIT BREAKERS & FUSES

- Recommended for applications where over-current protection is required
- Turn signal flashers are 12-volt, two-terminal flashers



Bulk #	Amps	Description	Qty
Fuses and Holder			
58440*	10 amps	ATC fuse	100
58460*	20 amps	ATC fuse	100
58470	10 amps	In-line fuse holder	12
Relays			
57000	--	'04 to present Nissan Armada and Titan without factory tow package	1

* Continued while supplies last

Bulk #	Amps	Description	Qty
Flashers			
58310	14 amps	Flasher 1-4 lamps or 2-8 hazard	1
58320*	14 amps	Flasher 2-3 lamps or 2-6 hazard	1
Circuit Breaker			
58341	15 amps	Universal circuit breaker	1
58351	20 amps	Universal circuit breaker	1
58361	30 amps	Universal circuit breaker	1
58371	40 amps	Universal circuit breaker	1

**ACCESSORIES
& TESTERS**

SLIT LOOM & CLAMP

- Protects loose wires against vibration and damage
- Keeps multiple wires contained in a single channel
- Slit lengthwise for easy application to wires
- Stronger and easier to use than a braided sleeve or wire spiral wrap

How to order slit loom

- Bulk tubing is sold by the foot and will be cut to length based on quantity. **Example:** 1 unit equals a 1' length of tube, 2 units equals a 2' length.
- Packaged tubing comes in 25 foot bundles



Bulk #	Pkg #	Description	Amount
58823	--	1/4" convoluted slit loom	See above
59824	59825	3/8" convoluted slit loom	See above
59826	59827	1/2" convoluted slit loom	See above
--	59828	3/8" ID nylon loom clamp	See above

**ACCESSORIES
& TESTERS**

ELECTRICAL TAPE & ZIP TIES

- Self-locking ties for securing wires and cables
- Zip tie mechanism allows for tight bundling
- Tapered end for easier insertion into lock



Bulk #	Length	Quantity	Specifications	Description
59728	7-1/4"	100	--	Zip ties
59732	14-1/4"	100	--	Zip ties
59740	60'	10-pack	7 mil x 3/4"	Electrical tape



WEIGHT DISTRIBUTION

FEATURED PRODUCTS



TruTrack™ 2-point hitches

With active sway control and weight distribution, TruTrack™ offers smooth, safe towing. Now available with Trunnion bars.



Trailer-mounted TruTrack™

This unique quick-connect weight distribution hitch allows you to quickly couple and uncouple without resetting the spring bars.



True Course™ sway control

An innovative, electric sway control system that prevents sway during emergency maneuvers, adverse road conditions, and heavy winds.

PRODUCT INDEX



188
What Is
TruTrack™



190
Trailer-Mounted
TruTrack™



192
Hitch-Mounted
TruTrack™



194
Trunnion Bar
WD Hitches



194
Round Bar
WD Hitches



195
WD Shanks
& Dual-Balls



196
True Course™
Sway Control



197
Sway
Control



197
Hook-Up
Brackets



198
Replacement
Parts

TRUTRACK™

WEIGHT DISTRIBUTION + SWAY CONTROL

CURT weight distribution hitches disperse the tongue weight of a trailer more evenly and provide more control and safer towing. TruTrack™ combines this functionality with sway control to deliver the safest, smoothest towing possible.



Without weight distribution

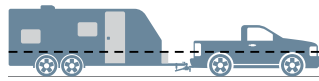

With weight distribution

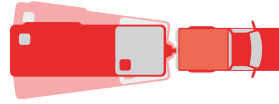

Without sway control



With sway control

MOUNTING OPTIONS

Trailer-Mounted

Advantages

- Patent-pending trailer-mounted design simplifies coupling and decoupling
- Independent, two-part system eases lifting by keeping hitch weight on trailer
- Upgraded spring bar and handle mechanism



Hitch-Mounted

Advantages

- Capacity ratings from 5k - 15k
- Optional shank-free version for deeper drop applications (#17600); shank sold separately



INTEGRATED SWAY CONTROL

How 2-Point (2P) Passive Sway Control Works

Friction resistance



Integrated sway control arms use friction to resist movement and keep the trailer aligned

Increased control



Heavy-duty, adjustable support brackets provide two points of passive sway control

INTEGRATED SWAY CONTROL (CONTINUED)

How 4-Point (4P) Active Sway Control Works

Spring-loaded bearings actively align trailer

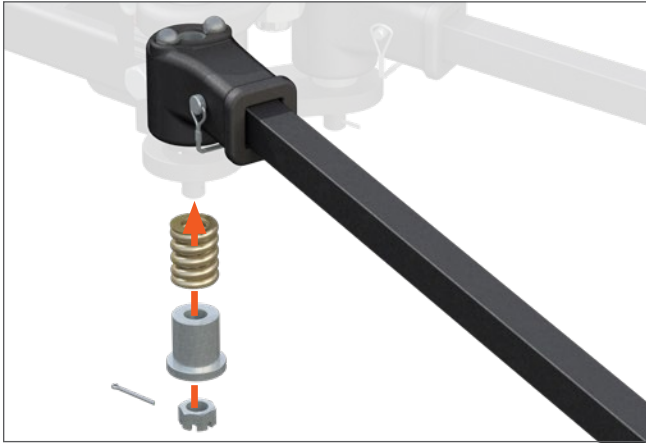

Scan to learn more



Bearings within the head maintain pressure on the spring bars, actively aligning the trailer with the vehicle

Active resistance



Lateral forces compress the bearings into a rotational groove to actively resist sway. The larger the sway event, the greater the resistance applied by the WD hitch

Increased control







Upward force on the ends of the spring bars tensions the bearings, directing them towards their 'home' position, increasing sway control

Smooth turning



During turns the bearings compress, allowing them to rotate freely. Afterwards they return to their tensioned, home position

THE TRUTRACK™ LINE-UP

Trailer-Mounted 4P	Trailer-Mounted 2P	Hitch-Mounted 4P	Hitch-Mounted 2P
 <p>17520 See page 190</p>	 <p>17510 See page 190</p>	 <p>17499 / 17500 / 17501 See page 192</p>	 <p>17600 / 17601 / 17355 See page 193</p>



QUICK-CONNECT COUPLING

TRAILER-MOUNTED TRUTRACK™ WD HITCHES

The revolutionary CURT TruTrack™ trailer-mounted weight distribution hitch features a quick-connect coupler that makes hitching up a breeze and doesn't require adjusting the trunnion bars once set up. Simply connect and disconnect with ease.

- Up to 10,000 lbs. GTW / 1,000 lbs. TW
- Prevents need to uninstall spring bars or remove hitch when disconnecting trailer
- Unique snap-up brackets mount trunnion bars with no additional tools needed to lift
- Innovative horn cradles trailer head, providing effortless coupling and locking into place with a single pin
- Integrated sway control reduces sway and levels the vehicle and trailer
- Brackets use friction to resist lateral movement and distribute weight evenly
- Adjustable brackets provide fixed support unlike spring bar chain models
- 7-hole, 2" shank can be adjusted 12-3/4" and flipped for 7-1/2" of rise or drop
- Available with fully integrated active sway control (4P) or passive sway control (2P) (see adjacent page for more information)
- Durable carbide powder coat finish
- **See page 198 for replacement parts**



17510 2-Point



Scan to learn more

Trailer-mounted



Patent-pending design allows the spring bars and trailer head to remain connected to the trailer when uncoupled

Integrated brackets



Prevents the need to uninstall spring bars or remove hitch when disconnecting trailer

Advanced leveling



Spring-loaded bars leverage trailer weight and spread it across all axles evenly

2 INCH TRAILER-MOUNTED TRUTRACK™ WD HITCHES

TruTrack™ 4-Point

- Four points of sway control work together to keep trailer aligned
- Integrated sway control actively resists sway and levels the vehicle and trailer
- Welded head with cast pieces and trunnion-style forged steel spring bars
- Uses spring & cam system with hardened components, instead of metal friction alone
- Black-oxide plated cams and stainless steel balls

• See page 198 for replacement parts



17520 4-Point

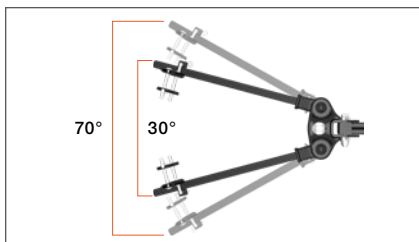

Two neutral spring bar settings can be positioned in the 30° or 70° position (+/-5°)



Head-tilt adjustment feature provides 15° of adjustment for precise leveling



Adjustable brackets provide fixed support unlike spring bar chain models

Part #	GTW	TW	Bar Length	Adjustment Range	Max Rise / Drop
17520	8,000 - 10,000 lbs.	800 - 1,000 lbs.	35"	12-3/4"	7-1/2"

TruTrack™ 2-Point

- Two distinct points of sway control work together to keep trailer aligned
- Integrated sway control reduces sway and levels the vehicle and trailer
- Heavy-duty, fabricated head can be used for precise leveling

• See page 198 for replacement parts



Two points of sway control use friction to keep trailer aligned



Head-tilt adjustment feature provides 15° of adjustment for precise leveling



Adjustable brackets provide fixed support unlike spring bar chain models

Part #	GTW	TW	Bar Length	Adjustment Range	Max Rise / Drop
17510	8,000 - 10,000 lbs.	800 - 1,000 lbs.	35"	12-3/4"	7-1/2"

Product Details

- Up to 15,000 lbs. GTW / 1,500 lbs. TW
- Four points of sway control work together to keep trailer aligned
- Welded head with cast pieces and trunnion-style forged steel spring bars
- Uses spring & cam system with hardened components, instead of metal friction alone
- Brackets use friction to resist lateral movement and distribute weight evenly while preventing trailer sway
- Durable carbide black powder coat finish, black-oxide plated cams and stainless steel balls
- See page 198 for replacement parts



17500

Product Features



Integrated sway control actively resists sway and levels the vehicle and trailer



Quick, easy tilt adjustment feature simplifies setup and installation (excluding 17501)



Adjustable brackets provide fixed support unlike spring bar chain models

Did You Know?

TruTrack™ 4P is designed to work in two neutral spring bar settings to fit almost all A-frame trailers. The spring bars can be positioned in the 30° or 70° position (+/-5°). Adjustment takes only 15 to 20 minutes, start to finish.

70°

30°

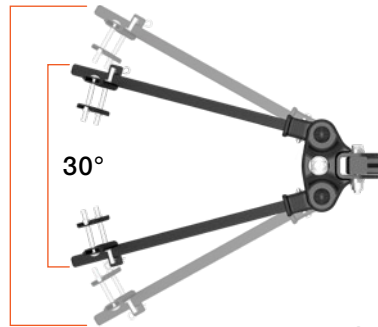

17499



17501

Part #	GTW	TW	Bar Length	Description
17499	5,000 - 8,000 lbs.	500 - 800 lbs.	35-9/16"	WD system only (trailer ball not included)
17500	8,000 - 10,000 lbs.	800 - 1,000 lbs.	35-9/16"	WD system (17500) and pre-torqued 2-5/16" trailer ball (40006)
17501	10,000 - 15,000 lbs.	1,000 - 1,500 lbs.	35-9/16"	WD system (17501) and pre-torqued 2-5/16" trailer ball (40030)

Product Details

- Up to 12,000 lbs. GTW / 1,200 lbs. TW
- Two distinct points of sway control work together to keep trailer aligned
- Integrated sway control reduces sway and levels the vehicle and trailer
- Brackets use friction to resist lateral movement and distribute weight evenly
- Head tilt adjustment feature simplifies setup and eliminates need for washers
- 7-hole, 2" shank can be flipped for maximum adjustability
- Equipped with durable, forged steel spring bars for reliable strength
- Heavy-duty, fabricated head can be used for precise leveling
- Adjustable brackets provide fixed support unlike spring bar chain models
- Durable carbide powder coat finish
- See page 198 for replacement parts



Product Features



Two points of sway control use friction to distribute weight evenly, keeping trailer aligned



Head tilt adjustment feature simplifies setup and eliminates the need for washers



Adjustable brackets provide fixed support unlike spring bar chain models



17600



17601

Part #	GTW	TW	Bar Style	Bar Length	Description
17355 N	8,000 - 12,000 lbs.	800 - 1,200 lbs.	Trunnion	35-9/16"	Hitch head, shank, spring bars with HD support brackets (17517), pre-torqued 2-5/16" trailer ball
17600	8,000 - 10,000 lbs.	800 - 1,000 lbs.	Round	35"	Hitch head, spring bars and lift brackets (shank and ball not included)
17601	8,000 - 10,000 lbs.	800 - 1,000 lbs.	Round	35"	Hitch head, shank, pre-torqued 2-5/16" trailer ball (40006), spring bars and lift brackets

2

INCH

ROUND BAR WD HITCHES & KITS

For additional shank
options see page 195

- Up to 14,000 lbs. GTW / 1,400 lbs. TW
- Weight ratings are limited to vehicle manufacturer's stated capacities
- Grease zerk fitting provides easy, continuous lubrication
- Heavy-duty, fabricated head with round, forged steel spring bars
- Features built-in sway control attachment tabs
- 2" shank can be flipped to provide necessary drop or rise
- Hookup brackets and lift handle allow for easy leveraging of spring bars
- Durable carbide black powder coat finish
- **See page 198 for replacement parts**



17063

Kit #	Hitch #	GTW	TW	Bar Length	Kit Includes
--	17050	5,000 - 6,000 lbs.	500 - 600 lbs.	31-3/16"	--
--	17051	6,000 - 8,000 lbs.	600 - 800 lbs.	31-3/16"	--
17062	17052	8,000 - 10,000 lbs.	800 - 1,000 lbs.	31-3/16"	Sway control (17200), pre-torqued 2-5/16" trailer ball (40006) and chains pre-assembled to spring bars
17063	17057	10,000 - 14,000 lbs.	1,000 - 1,400 lbs.	31-3/16"	Sway control (17200), pre-torqued 2-5/16" trailer ball (40030) and chains pre-assembled to spring bars

2

INCH

TRUNNION BAR KITS & WD HITCHES

- Up to 15,000 lbs. GTW / 1,500 lbs. TW
- Weight ratings are limited to vehicle manufacturer's stated capacities
- Heavy-duty, formed head with trunnion, forged steel spring bars
- Features built-in sway control attachment tabs
- 2" shank can be flipped to provide necessary drop or rise
- Hookup brackets and lift handle allow for easy leveraging of spring bars
- Durable carbide black powder coat finish
- **See page 198 for replacement parts**



17422

Kit #	Hitch #	GTW	TW	Bar Length	Kit Includes
--	17300*	5,000 - 6,000 lbs.	500 - 600 lbs.	30-5/8"	--
--	17302	8,000 - 10,000 lbs.	800 - 1,000 lbs.	30-5/8"	--
17322	17332	8,000 - 10,000 lbs.	800 - 1,000 lbs.	28-3/8"	Sway control (17200), pre-torqued 2-5/16" trailer ball (40006) and chains pre-assembled to spring bars
17422	17333	10,000 - 15,000 lbs.	1,000 - 1,500 lbs.	28-3/8"	Sway control (17200), pre-torqued 2-5/16" trailer ball (40030) and chains pre-assembled to spring bars

* Continued while supplies last

2 & **2½**
INCH INCH

WEIGHT DISTRIBUTION SHANKS

For WD shank dual-ball attachments see next page

- Provides an adjustable mount for most weight distribution hitches
- Features multiple holes for adjustable head height
- Can be flipped to provide necessary drop or rise (select models)
- 3/4" holes are spaced 1-1/4" from center to center
- Constructed from solid steel for reliable strength
- Protected by a durable black powder coat finish
- Limited to spring bar capacity



Measuring a WD shank

See table for corresponding measurements

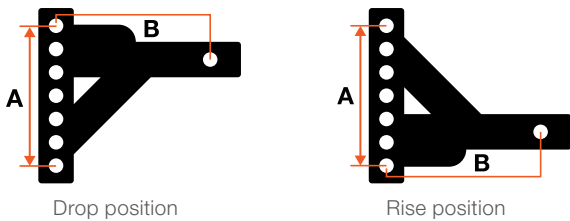

Measuring a WD shank with WD hitch head

Use the diagrams below as a guide for measuring your WD hitch

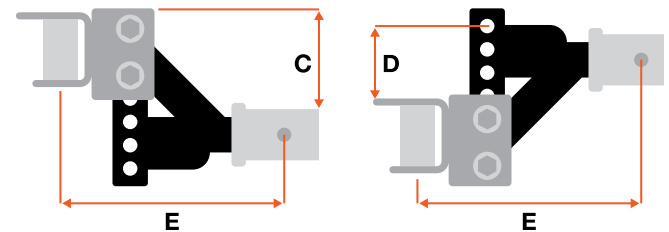

Part #	Weight Distribution Capacity (drop and rise)		Weight Carrying Capacity (drop only)		Measuring a WD Shank		Measuring a WD Shank with WD Hitch Head		
	GTW	TW	GTW	TW	Height (A)	Length (B)	Rise (C)	Drop (D)	Length (E)
For 2" x 2" Receiver Tube Openings									
17100	15,000 lbs.	1,500 lbs.	15,000 lbs.	1,500 lbs.	7-1/2"	8"			
17133†	15,000 lbs.	1,500 lbs.	15,000 lbs.	1,500 lbs.	7-1/2"	8"			
17102	15,000 lbs.	1,500 lbs.	15,000 lbs.	1,500 lbs.	7-1/2"	12"			
17103	15,000 lbs.	1,500 lbs.	15,000 lbs.	1,500 lbs.	7-1/2"	14"			
17120	15,000 lbs.	1,500 lbs.	15,000 lbs.	1,500 lbs.	8-3/4"	10"			
17121	15,000 lbs.	1,500 lbs.	15,000 lbs.	1,500 lbs.	10"	12"			
17122	15,000 lbs.	1,500 lbs.	15,000 lbs.	1,500 lbs.	10"	14"			
17123	15,000 lbs.	1,500 lbs.	15,000 lbs.	1,500 lbs.	11-1/4"	7"			
17134†	15,000 lbs.	1,500 lbs.	15,000 lbs.	1,500 lbs.	11-1/4"	7"			
17124*	15,000 lbs.	1,500 lbs.	15,000 lbs.	1,500 lbs.	6-1/4"	9"			
17125*	15,000 lbs.	1,500 lbs.	15,000 lbs.	1,500 lbs.	6-1/4"	8"			
For 2-1/2" x 2-1/2" Receiver Tube Openings									
17131†	15,000 lbs.	1,500 lbs.	15,000 lbs.	1,500 lbs.	7-1/2"	8"			
17132*†	15,000 lbs.	1,500 lbs.	15,000 lbs.	1,500 lbs.	12-1/2"	8"			

Measurements can vary per model of weight distribution hitch.

Use the diagrams above as a guide to measure your specific model.

* Not to be used in the rise position during weight distribution or weight carrying

† Forged steel construction

2

INCH

&

2 1/2

INCH

DUAL-BALL ATTACHMENTS FOR WEIGHT DISTRIBUTION SHANKS

- Instantly transforms your weight distribution shank into an adjustable ball mount
- Fits standard weight distribution shanks with holes spaced 2-1/2" on-center
- Adjustable design allows for quick and precise trailer leveling
- Compatible with all CURT weight distribution shanks (sold separately, see page 195)
- Built-in anti-rattle helps promote quiet towing
- **For additional information on WD dual-balls, see page 105**



Part #	Fits Shank Size	2" Ball GTW / TW	2-5/16" Ball GTW / TW	Includes	Ball Finish
45933	2"	10,000 / 1,000 lbs.	15,000 / 1,500 lbs.	Dual ball, two pins and clip	Chrome-plated
45934	2-1/2"	10,000 / 1,000 lbs.	20,000 / 2,000 lbs	Dual ball, two pins and clip	Yellow zinc-plated

TRUE COURSE™ TRAILER SWAY CONTROL SYSTEM

- Prevents trailer sway by activating brakes independently of driver and brake controller
- Compatible with multiple makes and models and thoroughly tested on real vehicles
- Module acts as intermediary for the trailer brake system, bypassing brake signal
- LED indicator on module shows when system is active and ready
- OneControl® mobile integration provides real-time, in-app notifications and displays system status
- Combats sway caused by side winds, slippery roads, sudden movement, and emergencies
- Advanced patent-pending technology electronically detects dangerous trailer movement
- Not compatible with electric over hydraulic brakes



Download the new OneControl® Auto app!



Download on the App Store

GET IT ON Google Play



51202



Prevents major sway not controlled by the WD hitch by pulsating all trailer brakes

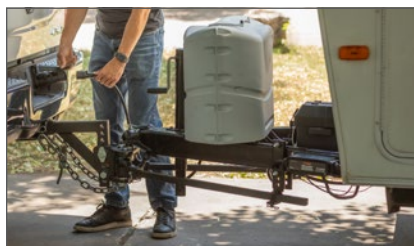

Easy plug-and-play installation; mount module on trailer and plug in adapters



Easy installation allows you to mount the module on the trailer frame and simply plug in

Part #	Plugs Into
51202	7-way RV blade

SWAY CONTROL KIT

Sway control reduces lateral movement while pulling a trailer. The diagrams below illustrate the effectiveness of using sway control units. Two sway control kits should be used for maximum control and stability.

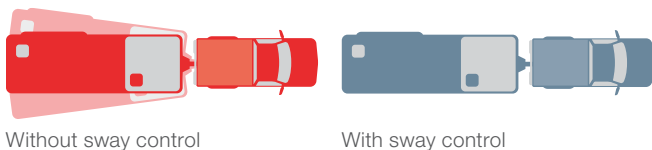

Part #	Includes
17200	Sway control unit
	Trailer attachment ball, plate and eight bolts
	Hitch-mounted attachment ball (40093)
	Weld-on tab (45822)
	Mount reinforcement plate
	Spring clips, qty 2

Replacement Parts

Bulk #	Pkg #	Description
17201	--	Trailer attachment ball and hardware
19289	--	Spring clip
45822	--	Weld-on sway tab
40093	40010	Sway control attachment ball

2 INCH SWAY TAB BALL MOUNT

- Fits any 2" x 2" receiver tube opening
- Provides a mounting tab for a sway control trailer ball (ball sold separately)
- Anti-rattle accessory can be used to help stop vibration, see page 125



Coupled sway control (17200)

Part #	GTW / TW	Drop	Rise	Length	Ball Hole Size
45820	7,500 / 750 lbs.	2"	3/4"	7-1/2"	1"

HOOKUP BRACKETS

- Allows for repositioning of spring bars around an LP tank or other obstruction
- Replaces factory spring bar brackets or hangers
- Durable carbide powder coat finish

Part #	Description
17003	Clamp-on chain hangers
17005	Bolt-on chain hangers



REPLACEMENT PARTS

ROUND BAR WD

Fig #	Part #	Description	Fits
1	17071	Spring bar with assembled chain	17050
1	17072	Spring bar with assembled chain	17051
1	17073	Spring bar with assembled chain	17052, 17062
1	17074	Spring bar with assembled chain	17057, 17062
2	17075	Head	All
3	17208	Hookup brackets, qty 2 - 17112 required to lift brackets	All
4	17112	Lift handle	17208
5	17111	Chain kit includes: - Chains, qty 2 - 3/8" U-bolts, qty 2 - 3/8" flat washers, qty 4 - 3/8" nylock nuts, qty 4	
6	17076	Hardware kit includes: - 3/4" x 4-1/2" hex bolts, qty 2 - 3/4" conical washers, qty 2 - 1/2" flat washers, qty 7 - 3/4" nylock nuts, qty 2 - Adjustment rod, qty 1 - Hitch pin & clip	All
7	19302	Retainer clip package	All

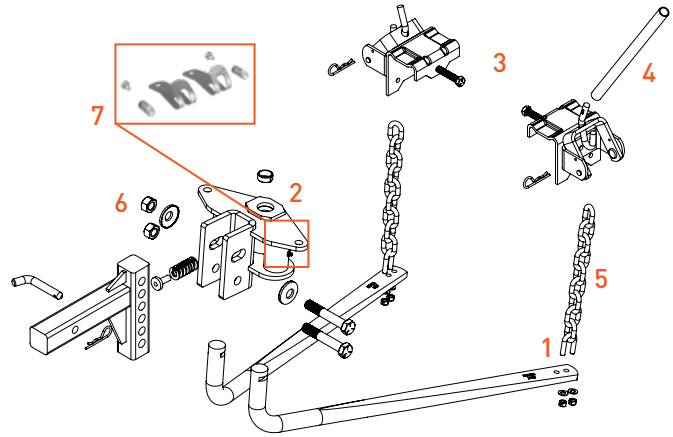

TRUNNION BAR WD

Fig #	Part #	Description	Fits
1	17303	Spring bar with assembled chain	17302
1	17336	Spring bar with assembled chain	17332
1	17337	Spring bar with assembled chain	17333
2	17307	Head	All
3	17008	Hookup bracket, qty 1	All
4	17112	Lift handle	All
5	17312	Head angle adjustment rod kit	All
6	17350	Hardware kit includes: - 3/4" x 5" hex bolts, qty 2 - 5/8" x 1-3/4" hex bolt, qty 1 - 1/2" x 2" hex bolts, qty 2 - 1/2" x 4" hex bolts, qty 2 - 3/4" conical washers, qty 4 - 1/2" flat washers, qty 2 - 3/4" nylock nuts, qty 2 - Adjustment rod, short, qty 1 - Adjustment rod, long, qty 1 - Bracket clips, qty 2 - Hitch pin & clip	All
7	17314	Conical washers, qty 4	All
8	17111	Chain kit includes: - Chains, qty 2 - 3/8" U-bolts, qty 2 - 3/8" flat washers, qty 4 - 3/8" nylock nuts, qty 4	All

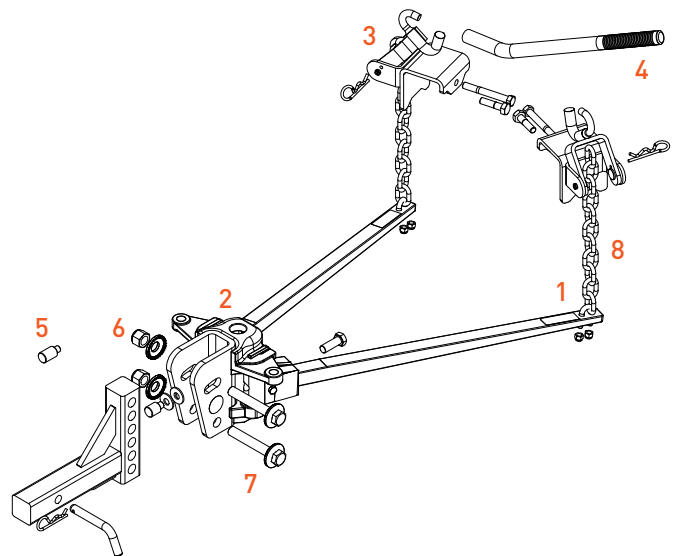

HITCH-MOUNTED TRUTRACK™

Fig #	Part #	Description	Fits
1	19276	Spring bar	17600, 17601, 17510
1	17535	Spring bar	17499
1	17536	Spring bar	17500
1	17537	Spring bar	17501
2	17506	Head (ball not included)	17499
2	17507	Head (ball not included)	17500
2	17509	Head (ball not included)	17501
2	19277	Head (ball not included)	17600, 17601
3	17512	Lift handle	All
4	17508	Support brackets, 6", qty 2	All
4	17515	Support brackets, 8", qty 2	All
4	17516	Support brackets, 10", qty 2	All
5	17513	L-pins & clips	17499, 17500, 17501, 17600, 17601
4	17517	HD support brackets, 6", qty 2	All
4	17518	HD support brackets, 8", qty 2	All
4	17519	HD support brackets, 10", qty 2	All
--	17514	HD L-pins & clips	17355
6	17550	Hardware kit includes: - 3/4" x 4" hex bolt, qty 1 - 3/4" x 5" hex bolt, qty 1 - 3/4" nylock nuts, qty 2 - Lynch pin, qty 2 - Head tilt spacer, qty 2 - Hitch pin & clip	17499, 17500
6	17554	Hardware kit includes: - 3/4" x 5" hex bolt, qty 2 - 5/8" x 1-1/2" hex bolt, qty 1 - 3/4" conical washers, qty 4 - 1/2" flat washers, qty 2 - Adjustment rod, short, qty 1 - Adjustment rod, long, qty 1 - 3/4" nylock nuts, qty 2 - Lynch pin, qty 2 - Hitch pin & clip	17501
6	19278	Hardware kit includes: - 3/4" x 5" hex bolt, qty 2 - 3/4" conical washers, qty 4 - 3/4" nylock nuts, qty 2 - 5/8" hex bolt, qty 1 - 5/8" square-head bolt, qty 1 - Hitch pin & clip	17600, 17601
7	17109	Retainer clip package	17600, 17601

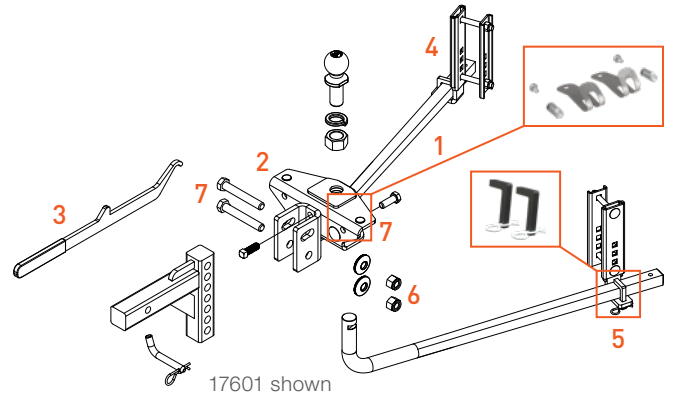
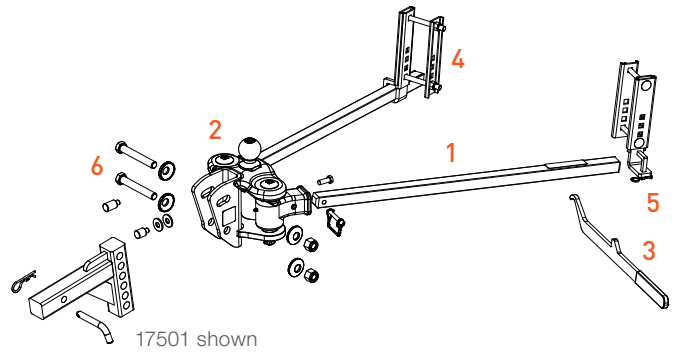
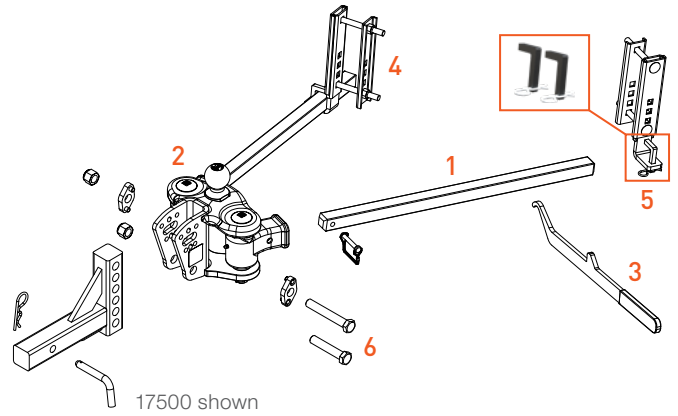

TRAILER-MOUNTED TRUTRACK™

Fig #	Part #	Description	Fits
1	19298	Complete bracket kit, qty 1	17510, 17520
2	19299	Horn only, qty 1	17510, 17520
3	19300	Hardware kit includes: - 3/4" x 5" hex bolt, qty 2 - 3/4" conical washers, qty 4 - 3/4" nylock nuts, qty 2 - 3/4" clevis pin & clip, qty 1	17510, 17520

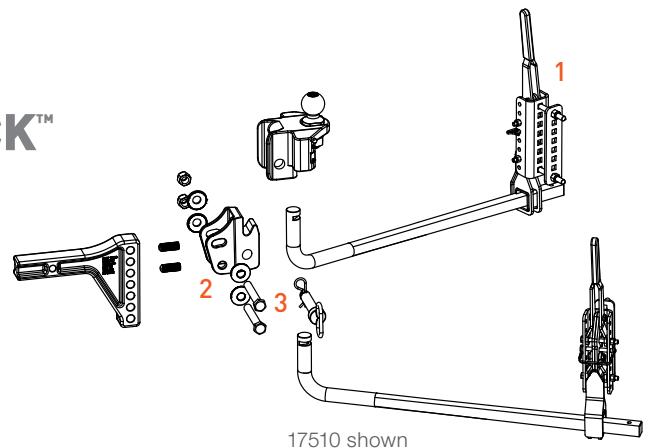



5TH WHEEL HITCHES

FEATURED PRODUCTS

Scan QR code for current applications or visit curtmfg.com



CrossWing™ hitch

CrossWing™ is lightweight, easy to install, and features a unique connection that auto-adjusts to guide the kingpin into place.



Helux™ coil-spring pin box

Helux™ features coil-spring technology that absorbs chucking, jerking, jarring, and vibration at the truck-trailer coupling point.



S-Series™ slider

S-Series™ sliders provide extra turning clearance for short-bed trucks and feature an auto-latching mechanism.

PRODUCT INDEX



204

How to Mount a 5th Wheel Hitch



206

CrossWing™ 5th Wheels



209

A-Series™ 5th Wheels



212

PowerRide™ 5th Wheels



214

E-Series™ 5th Wheels



218

Puck System Rails & Legs



220

5th Wheel Sliders



221

Brackets & Base Rails



224

X5™ Adapter Plates



225

5th Wheel Accessories



228

Helux™ Pin Boxes



230

5th Wheel Electrical

5TH WHEEL HITCHES

CURT 5th wheel hitches are available in four distinct series. To determine the best configuration for the customer's vehicle, see 'Mounting a 5th wheel hitch' on page 204.



CROSSWING™

- Rated for 20,000 lbs. GTW, page 206
- Self-guiding head guides kingpin into place
- 65% lighter than most traditional 5th wheels



A-SERIES™

- Options rated up to 30,000 lbs. GTW, page 209
- Cast yoke with poly-torsion inserts for stable towing
- Self-resetting handle for fewer steps while coupling



POWERRIDE™

- Rated for 30,000 lbs. GTW, page 212
- Tough, professional-grade, 30K capacity with enhanced ergonomics and functionality
- Multi-directional, cast yoke head for a smooth ride



E-SERIES™

- Rated for 16,000 lbs. GTW, page 214
- Economic design for budget-conscious customers
- Dual-pivoting head with anti-rattle skid plate

Feature	CrossWing	A-Series	PowerRide	E-Series
Pivoting Mechanism	Articulating head	Cast yoke (two pivot points)	Cast yoke (two pivot points)	10° dual-pivoting head
Handle Operation	Single-throw, quarter-turn	Single-throw, self-resetting handle	Single-throw, self-resetting handle	Single handle
Jaw Type	Funnel system	Dual, interlocking	Dual, interlocking	Locking bar
Coupling Indicator	Visible contact surface	Yes	Yes	No
Head Removal	Not applicable	One-pin	One-pin	Two-pin
Compatible with Sidewinder or Turning Point	Yes (wedge required)	Yes (wedge required)	Yes (wedge required)	Yes (wedge required)
Capacities Available	20K	16K, 20K, 25K, 30K	30K	16K
Finish	Carbide black	Carbide black	Teridium grey	Carbide black
Warranty	Limited lifetime	Limited lifetime	Limited lifetime	Limited lifetime

5TH WHEEL MOUNTING OPTIONS

OEM Puck System Products

Puck system legs and adapters use a simple quarter-turn anchor system to easily and securely drop into the truck bed pucks built into many pickups today.

- Options available for Ford, GM, Nissan and Ram
- Compatible with most CURT 5th wheel hitches
- **See page 218 for long- and short-bed options**



5th Wheel Sliders

CURT sliders and rollers provide 12" of additional clearance between the truck cab and trailer, displacing the 5th wheel coupling point for making tight turns.

- Ideal for increasing clearance for short-bed trucks
- Available in 20K and 25K capacities
- **See page 220 for full features and benefits**



Custom Under-Bed Brackets

Each designed to fit a specific truck application, our custom brackets install in less time and provide a solid mount for our industry-standard base rails.

- Vehicle-specific fit reduces or eliminates drilling
- Protected by a rust-resistant liquid A-coat
- **See page 221 for application information**



Industry-Standard Base Rails

CURT industry-standard base rails accept any 5th wheel hitch with industry-standard mounting points. They are available in capacities of 25K and 40K.

- Durable powder coat finish in multiple color options
- Co-cured in a rust-resistant liquid A-coat
- **See page 221 for application information**



X5™ Adapter Plates

X5 adapter plates allow a gooseneck hitch to become a 5th wheel mount. They drop into the gooseneck hole and provide a set of industry-standard base rails.

- Compatible with EZr™, Double Lock™ and select competitor models
- Compatible with CURT 5th wheels up to 20,000 lbs.
- **See page 224 for full features and benefits**



5th Wheel Accessories

We offer a number of accessories to help improve 5th wheel operation and safety while towing, including 5th wheel wedges, locks, noise dampeners and more.

- Lube plates and sound pads for smooth operation
- Safety chain loops and locks for improved safety
- **See pages 225 - 227 for 5th wheel accessories**



MOUNTING A 5TH WHEEL HITCH

There are several components that make up a 5th wheel hitch, and these components are determined by truck type and customer preferences. Answer the following questions to help choose the right hitch for your customer.

What Size is the Truck Bed?

The length of the truck bed will determine which type of mounting platform the 5th wheel hitch requires: legs or a slider. **Review each configuration and ensure adequate clearance before purchase.**

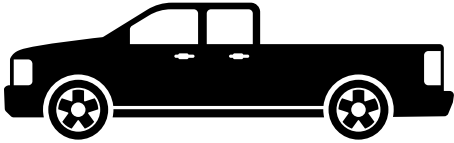

Long-bed (8 feet)

5th wheel legs are the standard 5th wheel mounting method. A long-bed truck should provide the necessary room for this option.

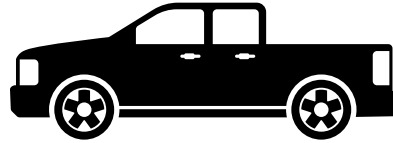

Short-bed (under 8 feet)

A 5th wheel slider is recommended on short-bed trucks. A slider adds clearance between the cab and the trailer when turning.

Measuring for a 5th wheel roller

1. Trailer width $\div 2 = X$
2. Distance from truck cab to coupling point = Y
3. Truck-trailer clearance: $Y - X = Z$

If Z is negative
you need a
5th wheel slider



Scan to
learn more

OEM PUCK SYSTEMS

Many trucks today, specifically from Ford, GM, Nissan and Ram, come with a built-in mounting platform in the bed called a puck system. A puck system makes installing a CURT 5th wheel hitch very easy.

Long-bed with OEM puck system

If the long bed has a puck system, select a 5th wheel hitch with OEM puck system legs or rails.

[See our complete kits starting on page 211.](#)

Short-bed with OEM puck system

If the short bed has a puck system, select an OEM puck system slider or rail option to mount the 5th wheel.

[See our complete kits starting on page 211.](#)

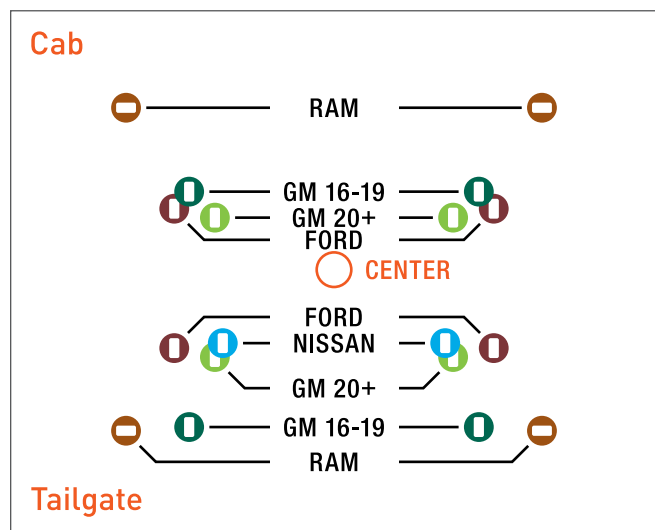

Puck system locations by manufacturer

PERMANENT RAIL SYSTEMS

If your customer prefers fixed rails in the truck bed, select a vehicle-specific, under-bed bracket kit and corresponding base rails to mount the 5th wheel hitch.

Long-bed

1. See page 221 for available bracket applications.
2. See page 221 for corresponding base rails.
3. Select a 5th wheel hitch from the 'Long-Bed Options' starting on page 210.

3. 5th wheel with legs



2. Above-bed base rails



1. Custom under-bed brackets



Short-bed

1. See page 221 for available bracket applications.
2. See page 221 for corresponding base rails.
3. Select a 5th wheel hitch from the 'Short-Bed Options' starting on page 210.

3. 5th wheel with slider



2. Above-bed base rails



1. Custom under-bed brackets



GOOSENECK TO 5TH WHEEL SYSTEMS

If your customer prefers the option of a gooseneck hitch, allowing for complete removal of the 5th wheel system and providing an unobstructed truck bed, select one of the options below.

CrossWing™ 5th wheel option

1. See page 250 for available gooseneck hitches.
2. See page 207 for CrossWing™ single-point.

2. CrossWing™ single-point 5th wheel



1. Gooseneck hitch or OEM puck system components



X5™ adapter bed rail option

1. See page 250 for available gooseneck hitches.
2. See page 224 for a corresponding X5 adapter.
3. Select a 5th wheel hitch starting on page 202.

3. 5th wheel with legs or slider



2. Above-bed X5 adapter

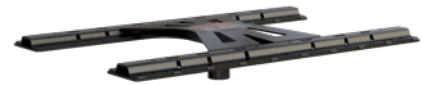

1. Under-bed gooseneck hitch kit



CROSSWING™

20K
GTW

LIGHTWEIGHT 5TH WHEEL HITCH

Scan to
learn more



Rail-Mount & Single-Point

- Premium steel construction offers robust 20,000-lb. capacity
- 65% lighter than most traditional 5th wheels
- Reinforced head connection point for superior strength and peace of mind
- Head channel guides kingpin into place for easier hookup
- Allows fore, aft and lateral head articulation when connecting on uneven terrain
- Three points of height adjustment (see table)
- Premium, carbide textured black finish
- Tested for safety in accordance with SAE J2638
- Not compatible with X5™ adapter



16600 - industry-standard rail hitch

See page 218 for puck system mounting options

Product Features



65% lighter than most traditional 5th wheel hitches (main body weighs up to 70 lbs.)



Unique coupling system eliminates guesswork by offering visible contact surface

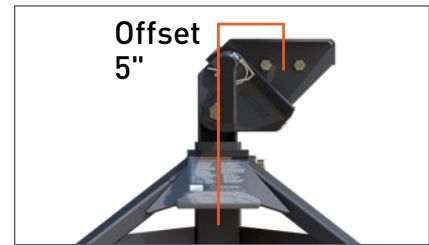

Coupling point offsets 5" rearward for added turning clearance (16600 only)

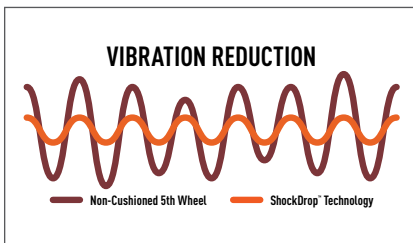

Features patent-pending ShockDrop technology to reduce jerking and jarring for a more comfortable towing experience



Easy-to-reach release handle for ergonomic locking and unlocking operation of the head from the side of the truck bed



Head piece bolts onto kingpin, allowing head channel to guide the kingpin into place for easier hookup

Part #	Description	GTW / Vertical Load	Offset	Body Weight	Height Range
16600	Industry-standard rail hitch	20,000 / 5,000 lbs.	5"	60 lbs.	16-3/8" - 20-3/8"

For safety chain loop options see page 208



LIGHTWEIGHT WITH DIRECT-STRIKE COUPLING

20K GTW SINGLE-POINT 5TH WHEEL HITCH

Single-Point Specific

- Mounts over the top of most standard height 2-5/16" aftermarket and OEM gooseneck balls
- Bed protector supports distribute forces across the truck bed, adding support and reducing bed wear while protecting the bed from fore-and-aft abrasions during starts and stops (#16040)
- #16602 intended for flatbed applications, bed protector supports not required



16051 single-point kit



Mounts over the top of most standard height 2-5/16" aftermarket and OEM gooseneck balls



Offset 8.4" Coupling point offsets 8.4" rearward for added turning clearance (16051 / 16602 only)



Bed supports with polyethylene inserts and rubber membrane deter sliding and scuffing

Part #	Description	Intended Use	GTW / Vertical Load	Offset	Body Weight	Height Range
16051	Single-point hitch (16602) with bed protector supports (16040)	Standard truck beds	20,000 / 5,000 lbs.	8.4"	70 lbs.	16-3/8" - 20-3/8"
16602	Single-point hitch only	Flatbed truck beds	20,000 / 5,000 lbs.	8.4"	70 lbs.	16-3/8" - 20-3/8"
16040	Single-point hitch bed protector supports only	Replacement part	--	--	--	--

CROSSWING™ SAFETY CHAIN LOOPS

- Easy to install with provided hardware
- Wide openings accept heavy-duty hooks and chains
- Durable carbide black powder coat finish



Provides a solid attachment point for 5th wheel safety chains in your truck bed



Provides a solid attachment point for 5th wheel safety chains in your truck bed



16615



16000



16612



16614



16613

Part #	GTW	For Use With	Includes	Finish
16612	20,000 lbs.	CrossWing industry-standard rail 5th wheel	Safety chain loops and CrossWing connection plate	Carbide black
16614	20,000 lbs.	CrossWing single-point 5th wheel	Safety chain loop plate and CrossWing connection plate	Carbide black
16613	20,000 lbs.	CrossWing industry-standard rail or single-point 5th wheel	CrossWing connection plate	Carbide black
16600	20,000 lbs.	All industry-standard base rails	Safety chain loops	Carbide black
16615	20,000 lbs.	CrossWing single-point 5th wheel	Safety chain loop plate	Carbide black

CROSSWING™ SINGLE-POINT SAFETY CHAIN LOOP COMPATIBILITY

If your safety chain loops fall within the shaded area, no additional safety chain accessories are required. See table below for CURT gooseneck hitch safety chain requirements.

Part #	Notes
60615, 60702, 60642, 60614, 60633, 61052, 65500	Can use existing gooseneck safety chain loops / anchors
60692, 60639	Can use existing gooseneck safety chain loops / anchors. GM 16 - 19 requires additional safety chain 16614 kit
60607, 60611, 60619, 60626, 60618, 60638, 61100	Requires additional safety chain 16614 kit

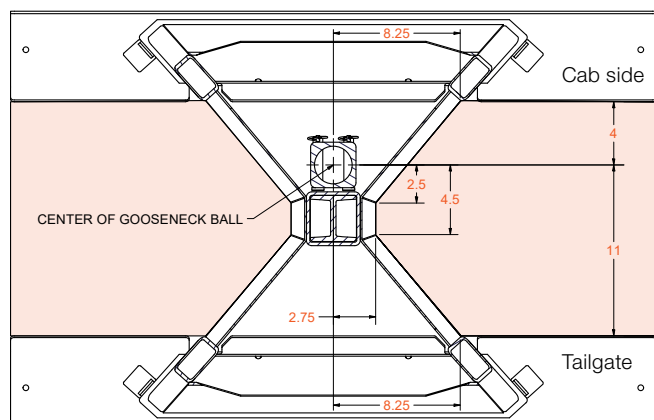

A-SERIES™

16k
GTW

A16™
HITCH

20k
GTW

A20™
HITCH

25k
GTW

A25™
HITCH

30k
GTW

A30™
HITCH

Product Details

- Up to 30,000 lbs. GTW / 7,500 lbs. vertical load
- Extra wide head opening for easier coupling
- Cast yoke and poly-torsion inserts suppress shock loads and reduce noise
- Constructed with a cast steel main body for a more precise build (A25 and A30 only)
- Offers three height adjustment positions to adapt to each unique truck bed
- Compatible with kingpin extension boxes, including common pivoting pin boxes (wedge #16992 required)
- Includes a polyethylene lube plate to eliminate messy grease deposits
- Protected by a highly durable carbide black powder coat finish
- Tested for safety in accordance with SAE J2638
- Patent# 8,827,298



16190

Operational Features



Lockable handle self-resets to the ready-to-couple position after the hitch is uncoupled



Fully articulating torsion head for controlled coupling and stable towing



Three-position coupling indicator clearly shows coupling status

Design Features

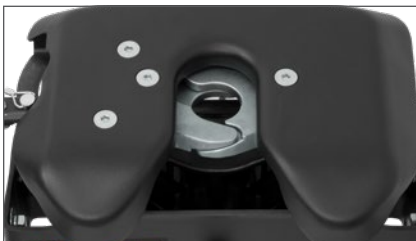

High-strength, interlocking jaws fully wrap the kingpin to minimize noise



Alignment pegs and accessible mounting bolts for simple leg-to-body attachment (excl A16)



Fast, one-pin head removal makes moving easy with smaller, lighter pieces

A-SERIES™ INDUSTRY-STANDARD RAIL KIT OPTIONS



16120 - A16 head with standard legs



16181 - A25 head with standard legs and base rails



16531 - A20 head with S20 slider



16651 - A25 head with S25 slider and base rails

Kit #	Head Series	GTW / Vertical Load	Kit Includes				Height Range
			Hitch with Standard Legs #	Head Only #	Slider Only #	Base Rails #	
Long-Bed Options							
16120	A16	16,000 / 4,000 lbs.	16120	--	--	--	13" - 17"
16121	A16	16,000 / 4,000 lbs.	16120	--	--	16200	14" - 18"
16140	A20	20,000 / 5,000 lbs.	16140	--	--	--	13" - 17"
16141	A20	20,000 / 5,000 lbs.	16140	--	--	16200	14" - 18"
16180	A25	25,000 / 6,250 lbs.	16180	--	--	--	13" - 17"
16181	A25	25,000 / 6,250 lbs.	16180	--	--	16200	14" - 18"
16190	A30	30,000 / 7,000 lbs.	16190	--	--	--	13" - 17"
16191	A30	30,000 / 7,000 lbs.	16190	--	--	16205	14" - 18"
Short-Bed Options							
16052	A16	16,000 / 4,000 lbs.	--	16520	16564	--	17-1/2" - 21-1/2"
16053	A16	16,000 / 4,000 lbs.	--	16520	16564	16204	18-1/2" - 22-1/2"
16531	A20	20,000 / 5,000 lbs.	--	16540	16564	--	17-1/2" - 21-1/2"
16631	A20	20,000 / 5,000 lbs.	--	16540	16564	16204	18-1/2" - 22-1/2"
16551	A25	25,000 / 6,250 lbs.	--	16580	16574	--	17-1/2" - 21-1/2"
16651	A25	25,000 / 6,250 lbs.	--	16580	16574	16204	18-1/2" - 22-1/2"

For a guide in selecting the mounting system for your customer's truck, see page 203

A-SERIES™ PUCK SYSTEM KIT OPTIONS

To learn more about puck systems see page 218



16070 - 2020 Chev / GMC legs with A30 head



16698 - Chev / GMC adapter with A20 & S20



16057 - GM / Ford base rail adapter with A25 & S25

Puck system products require a vehicle with a factory-installed 5th wheel prep package for installation

Make / Model	Bed	Years	GTW / Vertical Load	Kit #	5th Wheel Head		OEM Puck Products		Slider Only #	Height Range
					Head #	Series	Part #	Description		
Chevrolet / GMC										
Silverado Sierra 2500 HD 3500 HD	6.75'	20 - 25	25,000 / 6,250 lbs.	16057	16580	A25	16027	Rail adapter	16574	19" - 23"
			16,000 / 4,000 lbs.	16054*	16520	A16	16023*	Roller adapter	16564	19" - 23"
		16 - 19	20,000 / 5,000 lbs.	16698*	16540	A20	16023*	Roller adapter	16564	19" - 23"
			25,000 / 6,250 lbs.	16059	16580	A25	16050	Rail adapter	16574	20" - 24"
	8'	20 - 25	16,000 / 4,000 lbs.	16091	16520	A16	16029	Legs	--	13" - 17"
			20,000 / 5,000 lbs.	16092	16540	A20	16029	Legs	--	13" - 17"
			25,000 / 6,250 lbs.	16093	16580	A25	16029	Legs	--	13" - 17"
			30,000 / 7,000 lbs.	16070	16590	A30	16024	Legs	--	13" - 17"
		16 - 19	16,000 / 4,000 lbs.	16063	16520	A16	16025	Legs	--	13" - 17"
			20,000 / 5,000 lbs.	16064	16540	A20	16025	Legs	--	13" - 17"
		25,000 / 6,250 lbs.	16066	16580	A25	16025	Legs	--	13" - 17"	
Ford										
F-250 F-350 Super Duty	6.75'	11 - 25	25,000 / 6,250 lbs.	16057	16580	A25	16027	Rail adapter	16574	19" - 23"
	8'	11 - 25	16,000 / 4,000 lbs.	16033	16520	A16	16017	Legs	--	13" - 17"
			20,000 / 5,000 lbs.	16034	16540	A20	16017	Legs	--	13" - 17"
			25,000 / 6,250 lbs.	16036	16580	A25	16017	Legs	--	13" - 17"
Nissan										
Titan XD	8'	16 - 24	16,000 / 4,000 lbs.	16073	16520	A16	16026	Legs	--	13" - 17"
			20,000 / 5,000 lbs.	16074	16540	A20	16026	Legs	--	13" - 17"
Ram										
2500 3500	6.75'	13 - 25	16,000 / 4,000 lbs.	16056*	16520	A16	16022*	Roller adapter	16564	19" - 23"
			20,000 / 5,000 lbs.	16695*	16540	A20	16022*	Roller adapter	16564	19" - 23"
			25,000 / 6,250 lbs.	16058	16580	A25	16042	Rail adapter	16574	20" - 24"
	8'	13 - 25	16,000 / 4,000 lbs.	16043	16520	A16	16021	Legs	--	14" - 18"
			20,000 / 5,000 lbs.	16044	16540	A20	16021	Legs	--	14" - 18"
			25,000 / 6,250 lbs.	16046	16580	A25	16021	Legs	--	14" - 18"

* Continued while supplies last

POWERRIDE™

30K
GTW

30K
HITCH

Product Details

- Tested and rated to 30,000 lbs. GTW / 7,500 lbs. vertical load per SAE J2638 (must be used with #16205 base rails)
- Tough, professional-grade capacity and enhanced functionality
- Constructed with a cast steel main body for dependable strength
- Patented interlocking jaws for full kingpin contact and coupling security
- Premium, textured, dark grey teridium finish for lasting rust resistance
- Compatible with kingpin extension boxes, including common pivoting pin boxes (wedge required)
- 4" height adjustment for greater versatility versus 3" options
- No welding or fabrication required for installation
- Patent# 8,827,298



16320 - head with legs

Operational Features



Ergonomic, self-resetting handle for easier use from the side of the truck bed



Multi-directional, cast yoke head for a smooth ride and less strain on the truck



Three-position coupling indicator clearly shows coupling status

Design Features



Strategic grip points for ergonomic moving and handling



Integrated polyethylene plates for smooth operation, reduced wear and no grease



Fast, one-pin head removal makes moving easy with smaller, lighter pieces



POWER MEETS PERFORMANCE

POWERRIDE™ KIT OPTIONS

To learn more about puck systems see page 218



16321 - head with legs and 40K base rails



16594 - head with Ford puck legs

Industry-Standard Rail Options

Part #	Description	GTW / Vertical Load	Height Range
Long-Bed Options			
16320	Head with standard legs	30,000 / 7,500 lbs.	13" - 17"
16321	Head with standard legs (16320) and 40K base rails (16205)	30,000 / 7,500 lbs.	14" - 18"

For a guide in selecting the right 5th wheel for your customer's truck, see page 203

OEM Puck System Options

Make / Model	Style	Years	GTW / Vertical Load	Kit #	Head Only #	OEM Puck Leg #	Height Range
Chevrolet / GMC							
Silverado Sierra 2500 HD / 3500 HD	8' bed	20 - 25	30,000 / 7,500 lbs.	16592	16315	16030	13" - 17"
Ford							
F-250 / F-350 Super Duty	8' bed	11 - 25	30,000 / 7,500 lbs.	16594	16315	16032	13" - 17"
Ram							
2500 / 3500	8' bed	13 - 25	30,000 / 7,500 lbs.	16593	16315	16028	14" - 18"

Puck system products require a vehicle with a factory-installed 5th wheel prep package for installation

E-SERIES™

16K
GTW

E16™
HITCH

Product Details

- Up to 16,000 lbs. GTW / 4,000 lbs. vertical load
- Pivots on dual axes for 10° of lateral movement
- Automatically locks for easy, secure coupling
- Operates using a single handle with few moving parts
- Features an anti-rattle skid plate to help reduce noise
- Offers four height adjustment positions to adapt to each unique truck bed
- Compatible with kingpin extension boxes, including common pivoting pin boxes (wedge #16991 required)
- Protected by a highly durable carbide black powder coat finish
- Tested for safety in accordance with SAE J2638



16115

Product Features



Pivots on dual axes for 10° of lateral movement



Features an anti-rattle skid plate to help reduce noise



Single-handle operation with auto-lock for easy, secure coupling

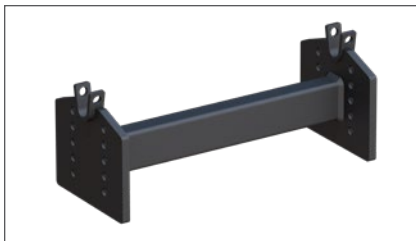

16505 head adapter allows CURT sliders to accept the 16515 E16 head (included in 16515, 16516 and 16616 kits)



RELIABLE, BUDGET-FRIENDLY TOWING

E-SERIES™ INDUSTRY-STANDARD RAIL KIT OPTIONS

See page 216 for puck system mounting options



16115 - E16 head with standard legs



16116 - E16 head with standard legs and base rails



16511 - E16 head with S20 slider



16611 - E16 head with S20 slider and base rails

Kit #	Head Series	GTW / Vertical Load	Kit Includes				Height Range
			Hitch with Standard Legs #	Head with Adapter Plate #	Slider Only #	Base Rails #	
Long-Bed Options							
16115	E16	16,000 / 4,000 lbs.	16115	--	--	--	13" - 17"
16116	E16	16,000 / 4,000 lbs.	16115	--	--	16200	14" - 18"
Short-Bed Options							
16511	E16	16,000 / 4,000 lbs.	--	16515	16564	--	14" - 17"
16611	E16	16,000 / 4,000 lbs.	--	16515	16564	16204	15" - 18"

For a guide in selecting the mounting system for your customer's truck, see page 203

E-SERIES™ PUCK SYSTEM KIT OPTIONS

To learn more about puck systems see page 218



16061 - 2019 Chev / GMC legs with E16 head



16031 - Ford legs with E16 head



16071 - Nissan legs with E16 head



16697 - Chev / GMC roller adapter with E16 head & S20 slider



16041 - Ram legs with E16 head



16694 - Ram roller adapter with E16 head and S20 slider

Puck system products require a vehicle with a factory-installed 5th wheel prep package for installation

Make / Model	Bed	Years	GTW / Vertical Load	Kit#	5th Wheel Head		OEM Puck Products		Slider Only #	Height Range
					Head Only #	Series	Part #	Description		
Chevrolet / GMC										
Silverado / Sierra 2500 HD / 3500 HD	6.75'	16 - 19	16,000 / 4,000 lbs.	16697*	16515	E16	16023*	Roller adapter	16564	16" - 19"
	8'	20 - 25	16,000 / 4,000 lbs.	16097	16515	E16	16029	Legs	--	11-1/2" - 13-1/2"
		16 - 19	16,000 / 4,000 lbs.	16061	16515	E16	16025	Legs	--	11-1/2" - 13-1/2"
Ford										
F-250 F-350 Super Duty	8'	11 - 25	16,000 / 4,000 lbs.	16031	16515	E16	16017	Legs	--	11-1/2" - 13-1/2"
Nissan										
Titan XD	8'	16 - 24	16,000 / 4,000 lbs.	16071	16515	E16	16026	Legs	--	11-1/2" - 13-1/2"
Ram										
2500 / 3500	6.75'	13 - 25	16,000 / 4,000 lbs.	16694*	16515	E16	16022*	Roller adapter	16564	16" - 19"
	8'	13 - 25	16,000 / 4,000 lbs.	16041	16515	E16	16021	Legs	--	12-1/2" - 15-1/2"

*Continued while supplies last



PUCK SYSTEM COMPONENTS

FOR TRUCKS WITH OEM PREP PACKAGE

- Allows CURT 5th wheel hitches to fit an OEM puck system
- Quarter-turn anchors allow for quick installation and removal
- Anchors can be adjusted to eliminate chocking between the legs or slider and the puck system
- Tested for safety in accordance with SAE J2638
- Highly durable carbide black or teridium grey powder coat finish
- Capacity limited to lowest-rated towing component



16028
Ram legs

How to install OEM puck system products



Step 1 - Drop OEM-compatible product into the truck bed puck system



Step 2 - Close the anchor levers to lock the 5th wheel into place



Step 3 - Secure levers with attached safety pins and you're ready to hitch up your trailer

OEM PUCK SYSTEM BASE RAIL ADAPTERS

- Convert the truck's puck system to industry-standard 5th wheel base rails
- No hitch leg reconfiguring or disassembly required



Easily transfer existing hitch from previous truck to new puck-equipped truck



Industry-standard rails accept most 5th wheel legs and rollers



16027 base rail adapter shown with A20 head and S20 slider (not included)

Make / Model	Style	Years	GTW	Adds Height	Part #
Chevrolet / GMC					
Silverado / Sierra 2500 HD / 3500 HD	With 5th wheel prep package	20 - 25	25,000 lbs.	2-1/4"	16027
		16 - 19	25,000 lbs.	2-1/4"	16050
Ford					
F-250 / F-350 Super Duty	With 5th wheel prep package	11 - 25	25,000 lbs.	2-1/4"	16027
Ram					
2500 / 3500	With 5th wheel prep package	13 - 25	25,000 lbs.	2-3/4"	16042



STREAMLINED 5TH WHEEL INSTALLATION

OEM PUCK SYSTEM 5TH WHEEL HITCH LEGS & ROLLER PRODUCTS

See our kitted options on pages 211, 213 and 216

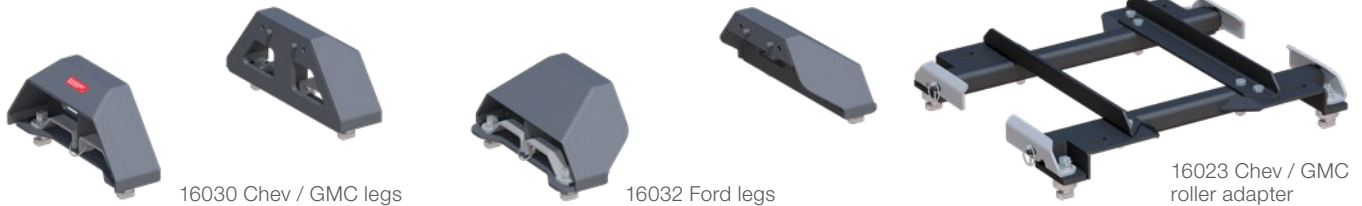

Puck system products require a vehicle with a factory installed 5th wheel prep package for installation

Make / Model	Style	Years	GTW	OEM Puck Products		
				Part #	Description	Finish
Chevrolet / GMC						
Silverado / Sierra 2500 HD / 3500 HD	6.75' bed with 5th wheel prep pkg	16 - 19	20,000 lbs.	16023*	Roller adapter	Carbide black
	8' bed with 5th wheel prep pkg	20 - 25	30,000 lbs.	16024	Legs	Carbide black
			30,000 lbs.	16030	Legs	Teridium grey
			25,000 lbs.	16029	Legs	Carbide black
			25,000 lbs.	16025	Legs	Carbide black
Ford						
F-250 / F-350 Super Duty	8' bed with 5th wheel prep pkg	11 - 25	24,000 lbs.	16017	Legs	Carbide black
			30,000 lbs.	16032	Legs	Teridium grey
Nissan						
Titan XD	8' bed with 5th wheel prep pkg	16 - 24	20,000 lbs.	16026	Legs	Carbide black
Ram						
2500 / 3500	6.75' bed with 5th wheel prep pkg	13 - 25	24,000 lbs.	16022*	Roller adapter	Carbide black
	8' bed with 5th wheel prep pkg	13 - 25	25,000 lbs.	16021	Legs	Carbide black
			30,000 lbs.	16028	Legs	Teridium grey

* Continued while supplies last



QUIET, SOLID DESIGN VIRTUALLY ELIMINATES CHUCKING

S-SERIES™

20K
GTW

S20™
SLIDER

25K
GTW

S25™
SLIDER

See our kitted options
on pages 210 - 216

Product Details

- Up to 25,000 lbs. GTW / 6,250 lbs. vertical load
- Smooth sliding between positions with no binding
- Automatically latches in both directions so you only have to exit the truck once
- Easy-to-reach lever arm for ergonomic operation
- Lever lift motion for user-friendly functionality vs. traditional pull-out style
- Tested for safety in accordance with SAE J2638
- Mount to all industry-standard base rails
- Protected by a highly durable carbide powder coat finish



16574

Greater maneuverability

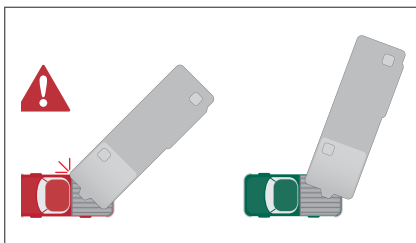

Provides 12" of displacement for the coupling point, adding turning clearance for short-bed trucks and avoiding trailer obstruction

Added convenience



Handle automatically locks into place when you drive forward, eliminating the need to exit the truck multiple times during hookup

Factory assembled



Ships fully assembled for fast, easy installation onto any industry-standard rails

Part #	GTW	Slider Series	Finish
16564	20,000 lbs.	S20	Carbide black
16574	25,000 lbs.	S25	Carbide black

PERMANENT RAIL SYSTEMS

CUSTOM UNDER-BED BRACKETS

Custom brackets provide a set of permanent 5th wheel base rails in the truck bed. If your customer prefers removable rails for no obstructions in the truck bed, [see page 224 for our gooseneck adapter options.](#)

Custom brackets

- Designed to be used in combination with industry-standard base rails (see application guide for part numbers)
- Vehicle-specific applications reduce or eliminate frame drilling, cutting installation time in half
- Protected by a rust-resistant liquid A-coat
- Includes mounting hardware
- Tested according to SAE J2638 specifications



16412 brackets shown with 16204 base rails

Semi-custom brackets

- Designed to be used in combination with CURT universal brackets and / or base rails (see application guide for part numbers)
- All semi-custom brackets require drilling to be installed

Step 1 - Pick vehicle-specific brackets starting on page 222

Step 2 - Select the base rails by finish preference & capacity

Step 3 - Start on page 202 to select a 5th wheel hitch

UNIVERSAL UNDER-BED BRACKETS & INDUSTRY-STANDARD BASE RAILS

Weight capacities limited to the lowest rated towing component

- **Industry-exclusive 40K option**
- Intended for vehicle applications not covered by CURT custom brackets
- Compatible with CURT and most competitive 5th wheel hitches, sliders and gooseneck adapters
- All universal brackets require drilling or welding to be installed
- Tested according to SAE J2638 specifications



Kit #	Base Rails Only #	Brackets & Hardware #	Capacity	Finish	Description
Base Rails & Brackets					
16150	--	--	25,000 lbs.	Gloss black	Two rails, 4-bolt
16100	16104	16101	25,000 lbs.	Gloss black	Two rails, 10-bolt
16200	16204	16101	25,000 lbs.	Carbide black	Two rails, 10-bolt
--	16205	--	40,000 lbs.	Teridium grey	Two rails, 10-bolt
Replacement Hardware					
16111	Installation hardware kit				
16103	Wheel bolts, qty 8 (for installing new brackets) Available in 10-pack #16103010 (10 sets of eight bolts)				



40K RAILS FULLY TESTED TO SAE J2638

APPLICATION GUIDE

Make / Model	Style	Years	Bracket Type	Bracket #	Drilling	Base Rails		
						40K Teridium#	25K Carbide #	25K Gloss #
Chevrolet								
Silverado 1500	Excl. 5.5' bed	19 - 25	Custom	16469	No	--	16204	16104
	--	07 - 18	Custom	16400	No	--	16204	16104
	--	99 - 06	Custom	16418	Yes	--	16204	16104
Silverado 1500 Classic	--	07 - 07	Custom	16418	Yes	--	16204	16104
Silverado 1500 LD	--	19 - 19	Custom	16400	No	--	16204	16104
Silverado 1500 LTD	Excl. 5.5' bed	22 - 22	Custom	16469	No	--	16204	16104
Silverado 2500	Excl. Cab & Chassis	99 - 04	Custom	16418	Yes	--	16204	16104
Silverado 2500 HD	--	20 - 25	Custom	16429 ¹	No	16205	16204	16104
		11 - 19	Custom	16411	No	--	16204	16104
	Excl. Cab & Chassis	01 - 10	Custom	16418	Yes	--	16204	16104
Silverado 2500 HD Classic	Excl. Cab & Chassis	07 - 07	Custom	16418	Yes	--	16204	16104
Silverado 3500	Excl. Cab & Chassis	01 - 06	Custom	16418	Yes	--	16204	16104
Silverado 3500 Classic	Excl. Cab & Chassis	07 - 07	Custom	16418	Yes	--	16204	16104
Silverado 3500 HD	Excl. Cab & Chassis	20 - 25	Custom	16429 ¹	No	16205	16204	16104
		11 - 19	Custom	16411	No	--	16204	16104
		08 - 10	Custom	16418	Yes	--	16204	16104
Dodge								
Ram 1500	--	09 - 10	Semi-Cust.	16306	Yes	--	16204	16104
	Extended crew cab	06 - 08	Custom	16420	No	--	16204	16104
	Excl. extended crew cab	02 - 08	Custom	16419	No	--	16204	16104
	--	02 - 08	Semi-Cust.	16303	Yes	--	16200	16100
Ram 2500 / 3500	Excl. Cab & Chassis	03 - 10	Custom	16420	No	--	16204	16104
		03 - 09	Semi-Cust.	16301	Yes	--	16200	16100

¹ Brackets rated up to 30,000 lbs. when used with #16205 (40K) base rails

Applications continued on the following page

Make / Model	Style	Years	Bracket Type	Bracket #	Drilling	Base Rails		
						40K Teridium#	25K Carbide #	25K Gloss #
Ford								
F-150	Excl. Lightning or Police Responder	22 - 24	Custom	16911	No	--	16204	16104
	Excl. Police Responder	15 - 21	Custom	16911	No	--	16204	16104
	Excl. 5.5' bed	04 - 14	Custom	16441	No	--	16204	16104
	--	04 - 11	Semi-Cust.	16300	Yes	--	16204	16104
		97 - 03	Custom	16437	No	--	16204	16104
F-150 Heritage	--	04 - 04	Custom	16437	No	--	16204	16104
F-250	--	97 - 99	Custom	16437	No	--	16204	16104
F-250 / F-350 Super Duty	Excl. Cab & Chassis	23 - 24	Custom	16432 ¹	No	--	16204	16104
		17 - 22	Semi-Cust.	16432 ¹	No	16205	16204	16104
		11 - 16	Custom	16424	No	--	16204	16104
		05 - 10	Custom	16448	Yes	--	16204	16104
		99 - 04	Custom	16443	Yes	--	16204	16104
F-450 Super Duty	Excl. Cab & Chassis	17 - 22	Semi-Cust.	16432 ¹	No	16205	16204	16104
		11 - 16	Custom	16424	No	--	16204	16104
		08 - 10	Custom	16448	Yes	--	16204	16104
GMC								
Sierra 1500	Excl. 5.5' bed	19 - 25	Custom	16469	No	--	16204	16104
	Excl. Denali	07 - 18	Custom	16400	No	--	16204	16104
	--	99 - 06	Custom	16418	Yes	--	16204	16104
Sierra 1500 Classic	--	07 - 07	Custom	16418	Yes	--	16204	16104
Sierra 1500 Limited	Excl. 5.5' bed	22 - 22	Custom	16469	No	--	16204	16104
	--	19 - 19	Custom	16400	No	--	16204	16104
Sierra 2500	Excl. Cab & Chassis	99 - 04	Custom	16418	Yes	--	16204	16104
Sierra 2500 HD	--	20 - 25	Custom	16429 ¹	No	16205	16204	16104
		11 - 19	Custom	16411	No	--	16204	16104
		01 - 10	Custom	16418	Yes	--	16204	16104
Sierra 2500 HD Classic	Excl. Cab & Chassis	07 - 07	Custom	16418	Yes	--	16204	16104
Sierra 3500	Excl. Cab & Chassis	01 - 06	Custom	16418	Yes	--	16204	16104
Sierra 3500 Classic	Excl. Cab & Chassis	07 - 07	Custom	16418	Yes	--	16204	16104
Sierra 3500 HD	Excl. Cab & Chassis	20 - 25	Custom	16429 ¹	No	16205	16204	16104
		11 - 19	Custom	16411	No	--	16204	16104
		07 - 10	Custom	16418	Yes	--	16204	16104
Nissan								
Titan	--	04 - 24	Custom	16470	Yes	--	16204	16104
Ram								
1500	Excl. TRX or multifunction tailgate	19 - 25	Custom	16307	No	--	16204	16104
	With factory air suspension	13 - 17	Custom	16444	Yes	--	16204	16104
	Coil springs, excl. Limited	11 - 18	Semi-Cust.	16306	Yes	--	16204	16104
1500 Classic	Coil springs	19 - 24	Semi-Cust.	16306	Yes	--	16204	16104
2500	Excl. 5th wheel prep pkg	14 - 24	Custom	16427	No	--	16204	16104
	--	13 - 13	Custom	16430 ¹	Yes	16205	16204	16104
		11 - 12	Custom	16420	No	--	16204	16104
3500	Excl. 5th wheel prep pkg	13 - 24	Custom	16430 ¹	Yes	16205	16204	16104
	Excl. Cab & Chassis	11 - 12	Custom	16420	No	--	16204	16104
Toyota								
Tundra	6.5' bed, excl. extended crew cab	07 - 21	Custom	16468	Yes	--	16204	16104
	Excl. extended crew cab	07 - 20	Semi-Cust.	16304	Yes	--	16200	16100

¹ Brackets rated up to 30,000 lbs. when used with #16205 (40K) base rails

GOOSENECK TO 5TH WHEEL

20k
GTW

X5™ GOOSENECK TO 5TH WHEEL ADAPTER PLATES

See page 207 for CrossWing™ single-point

The X5 adapter plate allows a gooseneck hitch to become a mounting platform for a 5th wheel hitch. The X5 shank simply drops into the gooseneck ball hole and instantly provides a set of industry-standard 5th wheel base rails.

See the table below for gooseneck hitch compatibility.

Product Details

- Converts a gooseneck hitch into a set of standard 5th wheel base rails
- No assembly or tools required – just drop it in, lock it and go
- For use with CURT and competitive 5th wheels up to 20,000 lbs.
- Capacity limited to lowest-rated towing component
- Accepts any standard CURT 5th wheel legs or slider (excludes OEM puck system products)
- Durable carbide black powder coat finish
- Co-cured in a rust-resistant liquid A-coat
- **Not compatible with OEM-style gooseneck hitches or turret-style pin boxes, such as Sidewinder™ or Turning Point™**
(Trademark of First Brands Group™)

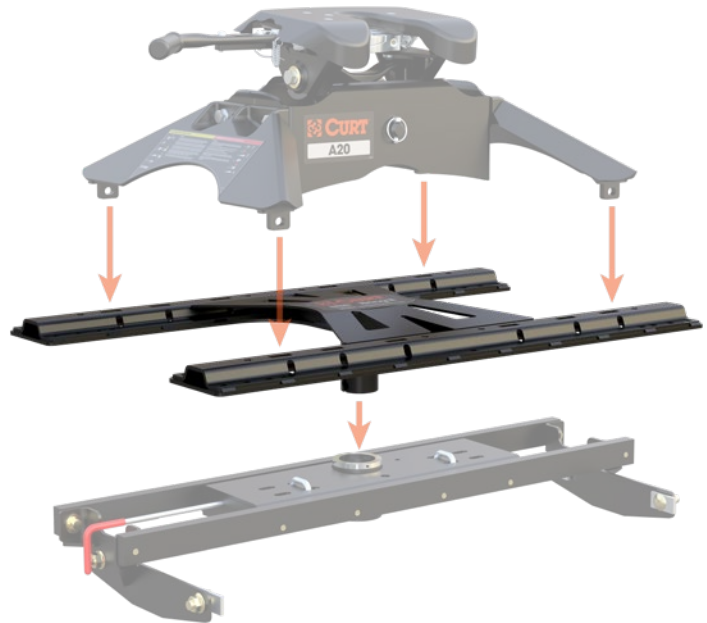

Step 1 - Pick a gooseneck hitch. If your customer has a gooseneck hitch, see step 2

Step 2 - Select the corresponding X5 adapter plate to match the gooseneck

Step 3 - See page 202 for our 5th wheel hitch selection guide



16210 - Fits CURT original Double Lock



16220 - Fits CURT Double Lock EZr



16310 - Fits B&W Turnoverball

Part #	Fits	Capacity	Shank Style
16210	CURT Double Lock 60607 and 60615	20,000 lbs.	Round shank
16220	CURT Double Lock EZr 60611 and 60619	20,000 lbs.	Round shank
16310	B&W Turnoverball® (excl. shallow models; shank hole is 2-1/4" from plate surface)	20,000 lbs.	Square shank

See page 262 for original Double Lock gooseneck hitches. See page 260 for Double Lock EZr gooseneck hitches

5TH WHEEL ACCESSORIES

5TH WHEEL SAFETY CHAIN LOOPS

See page 208 for CrossWing™ compatibility

- Easy to install with provided hardware
- Wide openings accept heavy-duty hooks and chains
- Durable carbide black powder coat finish



Provides a solid attachment point for 5th wheel safety chains in your truck bed



Universal design fits all industry-standard 5th wheel base rails



16615



16600



16612



16614



16613

Part #	GTW	For Use With	Includes	Finish
16612	20,000 lbs.	CrossWing industry-standard rail 5th wheel	Safety chain loops and CrossWing connection plate	Carbide black
16614	20,000 lbs.	CrossWing single-point 5th wheel	Safety chain loop plate and CrossWing connection plate	Carbide black
16613	20,000 lbs.	CrossWing industry-standard rail or single-point 5th wheel	CrossWing connection plate	Carbide black
16600	20,000 lbs.	All industry-standard base rails	Safety chain loops	Carbide black
16615	20,000 lbs.	CrossWing single-point 5th wheel	Safety chain loop plate	Carbide black

5TH WHEEL RAIL SOUND-DAMPENING PADS

- Helps eliminate clanking and rattling
- Compatible with all industry-standard 5th wheel legs, sliders and base rails (excluding OEM puck system products)
- Tough neoprene rubber

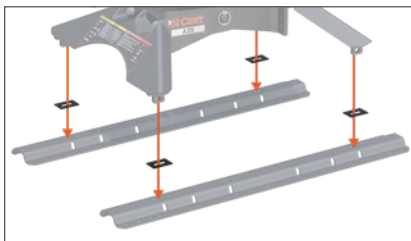

Place between a 5th wheel hitch and base rails to dampen sound



16901

16900

Bulk #	Pkg #	Quantity
16900	16901	4

5TH WHEEL HITCH LOCK

- Extra-long 1/2" diameter pin fits all industry-standard base rails
- Rust-free aluminum housing with a durable black powder coat finish
- Weather-resistant dust cap helps prevent internal corrosion
- Easy-to-access, 1/8-turn lock activation
- Includes two keys for added convenience



23256



Key slot angled upward for easier ergonomic access



Locks a 5th wheel hitch into the rails, taking the place of a pin & clip



Installs tight against the lip of the base rail for enhanced security

Part #	Pin Diameter	Finish
23256	1/2"	Black powder-coated aluminum, zinc plated pin

5TH WHEEL LUBE PLATES

- Reduces normal wear and tear when towing
- Eliminates messy grease deposits that trap dirt on hitch head plate
- 12" plate features self-cleaning grooves to maintain good lubrication
- Constructed from tough polyethylene



16722



16721



Adds a buffer between 5th wheel head plate and kingpin box



Fits any standard kingpin, simply snap it into place before coupling



16721025

Part #	25-Pack Tray #	Description
16721	16721025	10" 5th wheel lube plate
16722	--	12" slotted 5th wheel lube plate

KINGPIN LOCK

- Built with an aluminum body for corrosion resistance
- Two keys included for added convenience
- Space-saving, full-color retail packaging



Locks on to 5th wheel kingpin to deter theft of 5th wheel trailer



Universal design fits most 5th wheel trailer kingpins



23255

Part #	Description	Finish
23255	5th wheel trailer kingpin lock	Chrome-plated steel and powder-coated aluminum



5TH WHEEL WEDGES

A rotating 5th wheel pin box creates an alternative pivot point for the 5th wheel connection, providing the 5th wheel trailer with a wider turn radius. However, because of this secondary pivot point, the primary pivot point must be fixed to keep the trailer from wandering. A 5th wheel wedge bolts onto the pin box, locks up the kingpin and keeps it from swiveling.

- Allows CURT 5th wheel hitches to be used with rotating pin boxes, such as Sidewinder™ and Turning Point®
- Bolts on behind the kingpin of the pin box to restrict movement between 5th wheel hitch and pin box
- Durable carbide black powder coat finish
- Made in USA (may include imported hardware)

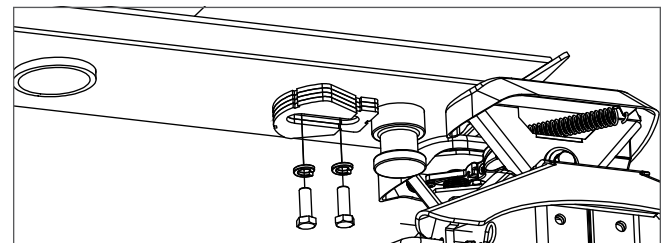

Restricts movement between the 5th wheel hitch and the rotating pin box, such as Sidewinder or Turning Point



16991



16992



16994

CURT 5th Wheel Hitch Model	Fits Rotating Pin Box Models	Part #
E-Series (page 214)	Turning Point (all) and 5th Airborne Sidewinder models excluding #68220	16991
A-Series (page 209)	Turning Point (all) and 5th Airborne Sidewinder models excluding #68220	16992
	Reese Sidewinder #68220 only	16994
CrossWing (page 206)	Turning Point (all) and 5th Airborne Sidewinder models excluding #68220	19283
	Reese Sidewinder #68220 only	19288



19288



19283

HELUX™ SERIES COIL SPRING PIN BOXES

NEW

- Reduces aggressive bouncing and shifting to increase the lifespan of the RV
- Prevents excessive rattling and vibrations from road hazards and degrading of RV hardware
- Easy-to-use coil spring technology and shock absorbers are maintenance free once installed
- Premium coil technology is more dependable and requires less maintenance than air systems
- Compatible with Rhino™ Box
- Tested for safety in accordance with SAE J2638



Significantly reduces jerking and jarring over traditional fixed pin boxes



Coil spring and shock technology extend life over torsion or air bags



Certified and approved on Lippert RV frames - will not void warranty

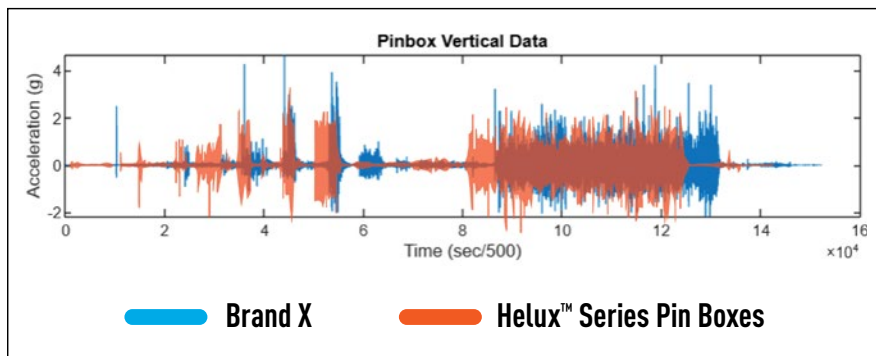

Part #	Capacity	Pin Weight	Minimum Pin Weight	GVWR Range
2024044570 N	24,000 lbs.	4,850 lbs.	2,570 lbs.	16701 - 19400
2024044571 N	24,000 lbs.	5,400 lbs.	2,860 lbs.	19401 - 21600
2024044572 N	24,000 lbs.	6,200 lbs.	3,290 lbs.	21601 - 24000



5TH WHEEL ELECTRICAL

CUSTOM WIRING EXTENSION HARNESSSES

- Routes a 7-way RV blade socket into truck bed while retaining use of rear socket
- Simple plug-and-play design eliminates the need for cutting or splicing
- Allows for easy connection of gooseneck wiring
- Requires 2-1/8" hole saw for installation
- Neoprene well nuts isolate steel bolts from aluminum surfaces (select models)
- **See page 162 for more information**

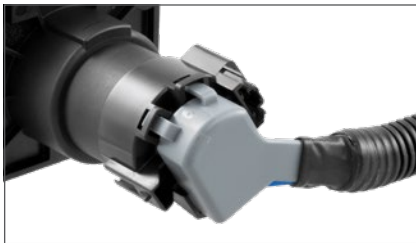

7-WAY RV BLADE EXTENSION HARNESS

- Routes existing 7-way RV blade socket into full-size pickup truck bed (7' length)
- Universal size fits any 7-way RV blade socket
- Allows for easy connection of gooseneck wiring
- **See page 164 for more information**



REPLACEMENT 7-WAY RV BLADE HARNESSSES

- Replaces the trailer-end plug of any 7-way harness
- Wires protected by heavy-duty, weather-resistant cable
- Cold-weather harnesses feature soft thermoplastic elastomer casing to remain flexible in cold temperatures (temperature rating from -40°F up to 221°F)
- **See page 165 for more information**



BRAKE CONTROLLERS

For a full list of benefits see pages 144 - 147

- Easily calibrated for all towing needs
- Proportional and time-delay units available



51200

Echo® in-line
Hidden under vehicle
Bluetooth-enabled
Smartphone-ready



51190

Echo® under-dash
Hidden under dash
Bluetooth-enabled
Smartphone-ready



51180

Echo® mobile
Portable design
Bluetooth-enabled
Smartphone-ready



51170

Spectrum™
Integrated OE look
Hidden main body
Tri-color LED display



51146

TriFlex™ NEXT
Tri-axis sensitivity
Auto adjustment
Digital display



51126

Discovery™ NEXT
Time-delay
Adjustable output
Digital display



51116

Venturer™ NEXT
Time-delay
Adjustable output
Ramp-up LED display

Dynamic power adjustment

Applies to Echo, Spectrum, Assure and TriFlex



Automatic power reduction for incline

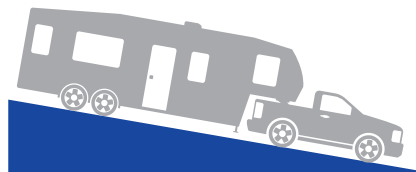

Automatic power increase for decline



Tri-axis circuit detects inertia on three planes for greater sensitivity over dual-axis models

Note: Values represented are for illustration only. The actual preset and adaptive values may differ from those shown here.

Name	Pkg #	6-Pack #	Axles	Brakes	Activation Method	Display	Mount Angle	Sleep Mode	Electric Over Hydraulic	Warranty
Echo in-line	51200	--	1 - 4	2 - 8	Proportional	Phone app	Any	Yes	No	Ltd lifetime
Echo under-dash	51190	--	1 - 4	2 - 8	Proportional	Phone app	Any	Yes	No	Ltd lifetime
Echo mobile	51180	--	1 - 2	2 - 4	Proportional	Phone app	Any	N/A	No	Ltd lifetime
Spectrum	51170	--	1 - 4	2 - 8	Proportional	Tri-color LED	Any	N/A	No	Ltd lifetime
TriFlex NEXT	51146	511466 N	1 - 4	2 - 8	Proportional	LED digital	Any	Yes	No	Ltd lifetime
Discovery NEXT	51126	511266 N	1 - 4	2 - 8	Time-delay	LED digital	Any	Yes	Yes	Ltd lifetime
Venturer NEXT	51116	511166 N	1 - 3	2 - 6	Time-delay	LED digital	Any	Yes	Yes	Ltd lifetime

REPLACEMENT PARTS

A-SERIES™ 5TH WHEEL REPLACEMENT PARTS

Fig #	Part #	Description	Fits
1	16520	A16 head only	16120
1	16540	A20 head only	16140
1	16580	A25 head only	16180
1	16590	A30 head only	16190
2	19211	A16 yoke support pin	16120
2	19213	A20 yoke support pin	16140
2	19214	A25 & A30 yoke support pin	16180, 16190
3	16920	A16 leg kit and hardware	16120
3	16906	A20 leg kit and hardware	16140
3	16907	A25 & A30 leg kit and hardware	16180, 16190
4	16902	Rail pins & clips, qty 4	All
5	19287	Torsion insert	All
6	19212	Handle assembly: - Release handle, qty 1 - Handle grip, qty 1 - Handle lock bar, qty 1 - M8 bolt head cap screw, qty 2 - Latch spring, qty 1 - M8 lock washer, qty 2	All

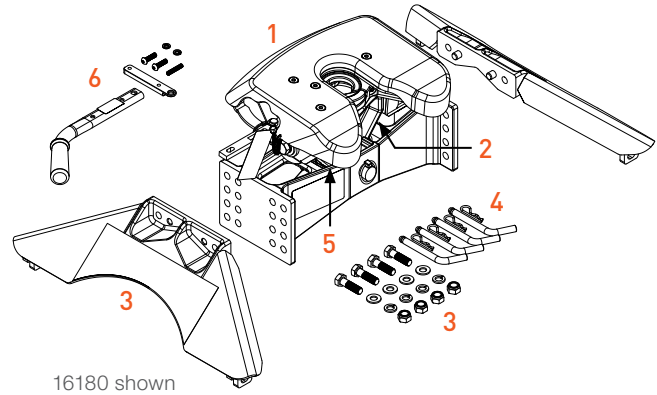

E-SERIES™ 5TH WHEEL REPLACEMENT PARTS

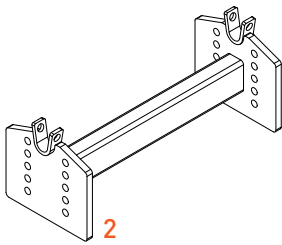
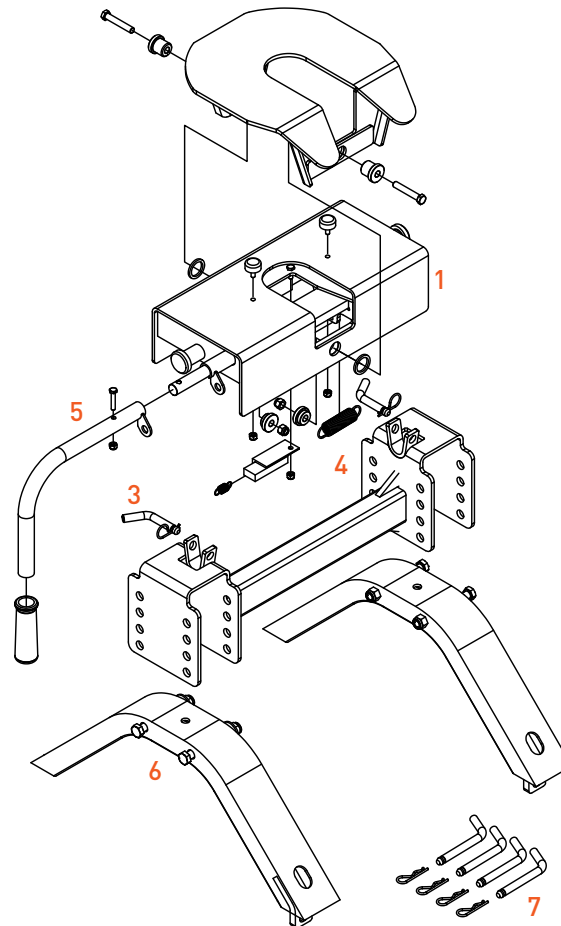
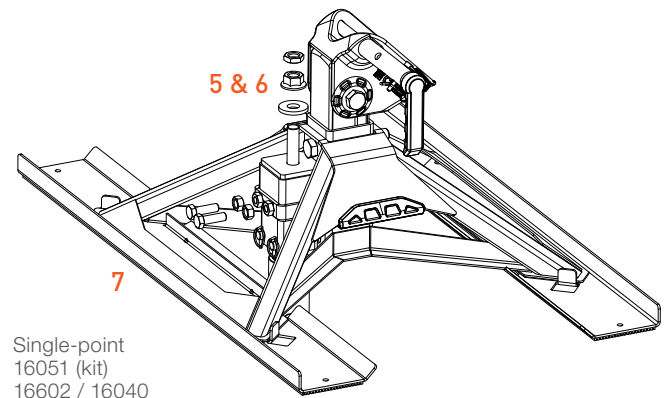
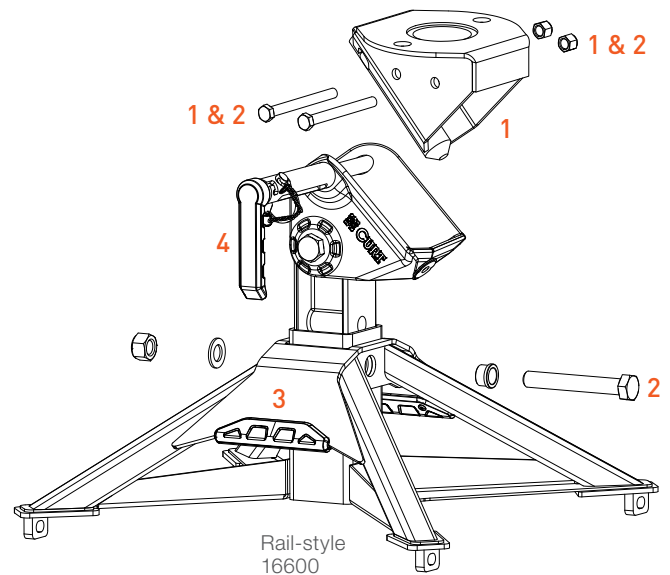

Fig #	Part #	Description	Fits
1	16515	E16 head with 16505 adapter	16115
2	16505	Head adapter	16115
3	19226	Head pinning kit: - Pin, qty 2 - Clip, qty 2	16115
4	19227	Head spring kit - Slide lock spring, qty 1 - Slide spring, qty 1	16115
5	19228	Handle assembly: - Handle, qty 1 - Handle grip, qty 1 - M6 hex head cap screw, qty 1 - M6 nylock nut, qty 1	16115
6	16903	E16 leg kit and hardware	16115
7	16902	Rail pins & clips, qty 4	16115



CROSSWING™ 5TH WHEEL REPLACEMENT PARTS

Fig #	Part #	Description	Fits
1	19295	Kingpin coupling attachment and installation hardware: - Upper weldment, qty 1 - 1/2" hex bolts, qty 2 - 1/2" nylock nuts, qty 2	16600 16051 16602
2	19286	Replacement hardware: - M20 hex bolt, qty 1 - Bushing, qty 1 - M20 flat washer, qty 1 - M20 nylock nut, qty 1 - 1/2" hex bolts, qty 2 - 1/2" nylock nuts, qty 2	16600 16051 16602
3	19273	Body grip handle kit - Handle grip inner, qty 2 - Handle grip outer, qty 2 - M4 button head bolts, qty 4 - M4 lock washers, qty 4	16600 16051 16602
4	19279	Handle grip kit - Handle, qty 1 - Bearing and spring, qty 1 - Shoulder screw, qty 1 - Wire-lock pin, qty 1 - 16mm key rings, qty 2 - Twisted link chain, qty 1	16600 16051 16602
5	19280	Coupler tube kit - Coupler tube, qty 1 - M20 x 130mm carriage bolt, qty 1 - M20 x 90mm carriage bolt, qty 1 - M20 flange nut, qty 1 - M20 jam nut, qty 1 - Flat washer, qty 1 - M14 hex bolts, qty 2 - M14 hex nuts, qty 2 - Lynch pins, qty 2 - Pin, qty 2	16051 16602
6	19281	Coupler tube hardware - M20 x 130mm carriage bolt, qty 1 - M20 x 90mm carriage bolt, qty 1 - M20 flange nut, qty 1 - M20 jam nut, qty 1 - Flat washer, qty 1	16051 16602
7	19282	Skid pads, qty 2	16051 16040



POWERRIDE™ 5TH WHEEL REPLACEMENT PARTS

Fig #	Part #	Description	Fits
1	16315	Head only	All
2	19269	Lube plates, qty 2	All
3	16908	Leg kit and hardware	All

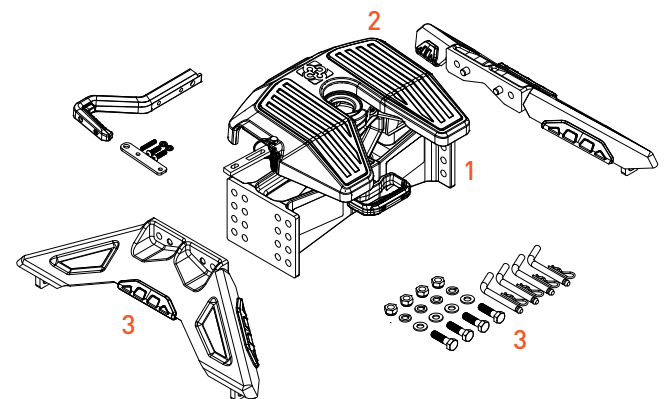

Q-SERIES™ 5TH WHEEL REPLACEMENT PARTS

Q-Series™ hitches have been retired.

For the same great features and even more, please refer to our A-Series on page 209.

Fig #	Part #	Description	Fits
--	19223	Grease zerk, qty 3 (not pictured)	All
1	19215	Handle grip	All
2	19216	Handle with indicators	All
3	19224	Handle lock assembly: - 140mm chain, qty 1 - Lynch pin, qty 1 - Handle flip lock, qty 1 - M6 screw, qty 2 - M6 nylock nut, qty 1 - 16mm key ring, qty 2	All
4	19221	Head pinning kit: - Retainer cap pin, qty 2 - Pin grip, qty 2 - Pin clip, qty 2 - Grommet, thick, qty 4 - Grommet, thin, qty 2	All
5	19222	16125 service kit 9 & 10: - Anti-orbit pad, qty 1 - Molded anti-orbit pad, qty 2 - M10 carriage bolt, qty 2 - M10 nylock nut, qty 2 - M10 button head bolt, qty 2 - Square retaining washer, qty 2	All
6	16530*	Q20 head only	16130
7	16904*	Q20 leg kit and hardware	16130
8	19225*	Q20 leg spacer plates, qty 4	16130

* Continued while supplies last

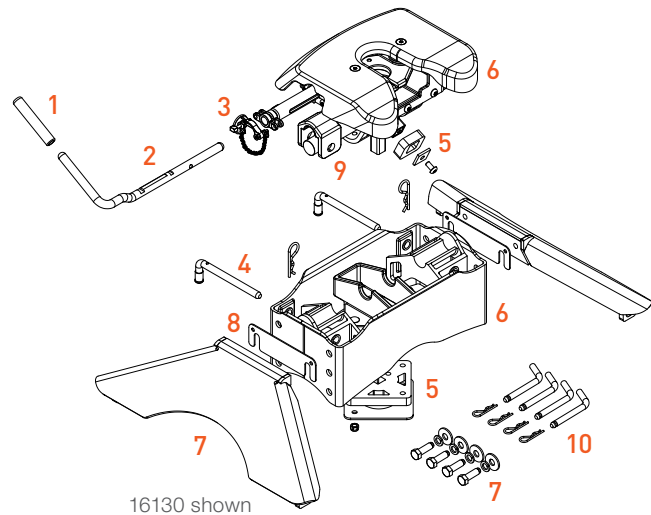

Fig #	Part #	Description	Fits
6	16545*	Q24 head only	16245
7	16913*	Q24 leg kit and hardware	16245
7	16963*	Q25 leg kit and hardware	16265
9	16914	Bearing shaft top clips, qty 2	All
10	16902	Rail pins & clips, qty 4	All

* Continued while supplies last

OEM PUCK SYSTEM REPLACEMENT PARTS

Part #	Description	Fits
19201	Handles, qty 4	16017, 16020, 16024, 16029
19205	Handles, qty 4	16021
19206	Handles, qty 4	16022
19207	Handles, qty 4	16023
19209	Handles, qty 4	16025
19202	Puck kit: - Locking T-bolts, qty 4 - Pucks, qty 4 - Castle nuts, qty 4 - Cotter pins, qty 4 - Washers, qty 4	16017, 16020, 16024, 16029
19203	Puck kit (rear of bed): - Locking T-bolts, qty 2 (lrg) - Pucks, qty 2 - Castle nuts, qty 2 - Cotter pins, qty 4	16021, 16022

Part #	Description	Fits
19204	Puck kit (front of bed): - Locking T-bolts, qty 2 (small) - Pucks, qty 2 - Castle nuts, qty 2 - Cotter pins, qty 4	16021, 16022
19208	Puck kit: - Locking T-bolts, qty 4 - Pucks, qty 4 - Castle nuts, qty 4 - Cotter pins, qty 4 - Washers, qty 4	16023
19210	Puck kit: - Locking T-bolts, qty 4 - Pucks, qty 4 - Castle nuts, qty 4 - Cotter pins, qty 4 - Washers, qty 4	16025

S-SERIES™ SLIDER REPLACEMENT PARTS

Fig #	Part #	Description	Fits
1	19102	Rail kit: - Half-round rails, qty 2 - M6 button head screws, qty 4 - M6 flat head screws, qty 4 - Lock washers, qty 4	All
2	19103	Rubber bumpers, qty 4	All
3	19104	Roller kit: - Roller sleeve, qty 1 - Roller, qty 1 - M16 Hex bolt, qty 1 - M16 nylock nut, qty 1	All
4	19105	Pin plate kit: - Pin plates, qty 2 - M14 hex bolt, qty 4 - M14 flat washers, qty 4 - M14 nylock nuts, qty 4	16574
5	19106	Wire-lock pin, qty 1	All
6	19107	Handle kit: - Locking handle, qty 1 - M6 shoulder bolt, qty 1 - M6 nylock nut, qty 1 - M8 hex bolt, qty 1 - M8 flat washers, qty 2 - M8 nylock nut, qty 1	All

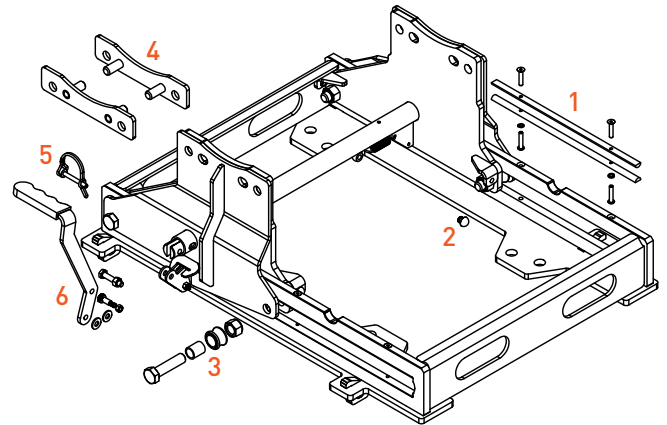

R-SERIES™ ROLLER REPLACEMENT PARTS

R-Series™ rollers have been retired.

For the same great features and even more, please refer to our S-Series on page 220.

Fig #	Part #	Description	Fits
1	19217	Roller wheel kit: - Roller wheel, qty 1 - M8 shoulder bolt, qty 1	All
2	19218	Head mounting hardware: - M14 hex bolt, qty 4 - M14 flat washer, qty 4 - M14 lock washer, qty 4 - M14 nylock nut, qty 4	All
3	19219	R16 handle assembly: - Handle, qty 1 - Handle grip, qty 1 - M6 hex bolt, qty 1 - M6 nylock nut, qty 1	16560
4	19220	R20 & R24 handle assembly: - Handle, qty 1 - Handle grip, qty 1 - M6 hex bolt, qty 1 - M6 nylock nut, qty 1	16550, 16570
5	16902	Rail pins & clips, qty 4	All

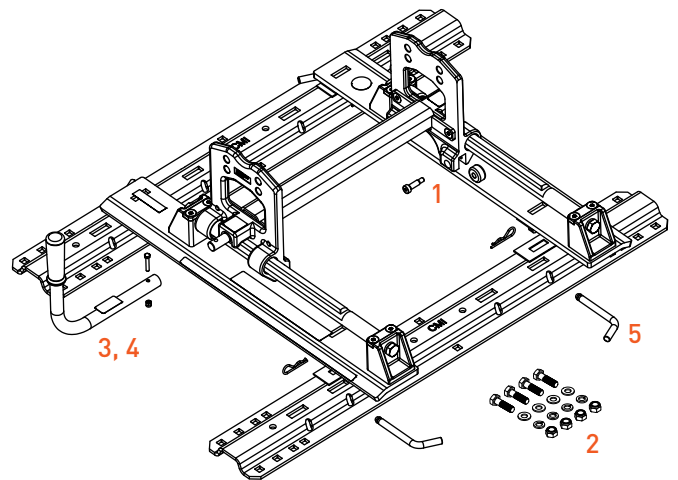



FLAT TOWING

FEATURED PRODUCTS

Scan QR code for current applications or visit curtmfg.com



Seeker™ tow bar
 With its advanced design and innovative, hands-free locking sleeve, the CURT Seeker™ tow bar eliminates the struggle of hookups.



Rambler™ tow bar
 This sleek, powerful tow bar is engineered for smooth non-binding operation, easy portability and dependable towing.



Fuse bypass switches
 CURT fuse bypass switches make flat towing your vehicle easier by eliminating the need to constantly remove and replace fuses.

PRODUCT INDEX



238
 Seeker™
 Tow Bar



239
 Rambler™
 Tow Bar



239
 Tow Bar
 Base Plates



243
 Tow Bar
 Accessories



244
 Universal
 Tow Bars



245
 Flat Towing
 Accessories



246
 Dinghy Towing
 Adapters



247
 RV
 Harnesses



TRUST THE TOWING EXPERTS.



2

INCH

SEEKER™ STEEL TOW BAR

NEW

- High-strength steel construction rated for 10,000 lbs. gross towed vehicle weight
- Innovative sleeve automatically locks for hands-free operation on uneven ground
- Three-lug shackle ends for less stress on the base plate tabs
- Active slide resistance provides enhanced control when extending the arms
- Rigorously tested for proven safety and performance
- Full articulating head and shackles to prevent binding on rough, uneven terrain

Three stowing positions to avoid obstructions

Auto-locking pin allows for quick and easy stowing



Innovative sleeve automatically locks for hands-free operation on uneven ground

Three-lug shackle ends for less stress on the base plate tabs

Extended arm length for extra hookup radius

Fully sealed design protects against debris

Part #	GTVW	Shank Size	Finish
70012 N	10,000 lbs.	2"	Textured black



2
INCH

RAMBLER™ STEEL TOW BAR

Scan to
learn more



- Full articulating head and shackles to prevent binding on rough, uneven terrain
- Rigorous physical testing for proven safety and performance
- Polymer isolator washers reduce friction for smooth, anti-rattle operation
- Premium textured black finish for lasting corrosion and wear resistance
- Compatible with CURT or Blue Ox® base plates (sold separately)



Non-binding latches



Patent-pending, non-binding latches for easy release on uneven ground

Three stowing positions



Three stowing positions to avoid obstructions and maximize versatility

Lightweight



With a total weight of only 40 pounds, the Rambler is easy to lift, carry and install

Part #	GTVW	Shank Size	Finish
70001	7,500 lbs.	2"	Textured black



CUSTOM-FIT TOW BAR BASE PLATES

For base plate application
guide see page 240

- Distributes weight equally for reduced stress on the vehicle frame
- Made with a vehicle-specific design for a custom fit
- Precisely welded for superior strength and longevity
- Physically tested to gross vehicle weight rating (GVWR)
- Co-cured in a rust-resistant liquid A-coat with a gloss black powder coat finish (zinc-plated attachment tabs)



Simplified design



Our simplified base plate designs provide improved fitment on each vehicle

High-quality components

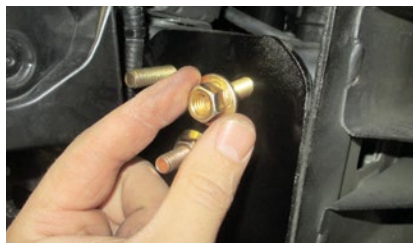

Large 1/4" thick spacers and upgraded hardware for better performance

Streamlined installation



Our comprehensive instruction manuals walk through the installation step-by-step



TOW BAR BASE PLATES

Installation may be too difficult for some users. Visit curtmfg.com/storelocator to find an installer. Always consult your vehicle owner's manual for proper flat towing procedures and limitations. Never exceed the recommended gross vehicle weight rating (GVWR).

RV HARNESSES

Add-On
#58919 - non-powered converter add-on compatible
#58920 - powered converter add-on compatible

Make / Model	Style / Notes	Years	Part #	Foot Notes	PC	Tab Ht.	Tab Width	Ins Time (hrs)	Years	Part #	Foot Notes	PC	Ins Diff.	Add-On #
Buick														
Enclave	--	08-17	70124*	A, C, D, E, I	103	17.75"	18"	3.0	13-17	58908	--	E35	Mod.	--
									08-12	58932	--	E26	Mod.	--
Envision	--	16-20	70117	A, C, D, E, G, I	103	17.25"	24"	3.0	16-20	58968	--	E26	Easy	--
Cadillac														
Escalade	--	15-20	70111	A, C, D, E	98	17.5"	32.5"	3.0	15-20	58965	--	E29	Easy	--
SRX	--	10-16	70123	A, C, I	103	16.5"	18"	3.0	--	--	--	--	--	--
Chevrolet														
Blazer	--	19-25	70138	A, C, D, E, I	103	13.5"	20"	4.0	--	--	--	--	--	--
Colorado	--	15-22	70144	C, G	98	13.5"	30.5"	3.5	15-22	58910	--	E21	Easy	--
		15-20	70107*	C, E, G, I	103	23"	28"	3.5						
Equinox	Excluding lower shutters	18-24	70108	A, C, E, I	98	16"	23"	4.0	22-24	52105	w/ LED taillights	E26	Mod.	--
										58988	w/o LED taillights	E25	Mod.	--
	--	10-17	70109	A, C, D, E, G, I	103	15.5"	24"	3.0	18-21	58974	w/ LED taillights	E19	Mod.	--
										58971	w/o LED taillights	E30	Mod.	--
Silverado 1500	Excluding 2.7L	19-24	70141	A, C, F	99	21"	31.25"	3.0	19-24	58984	--	E25	Easy	--
	--	19-21	70146	A, C, F	89	19.5"	18"	3.0	16-18	58967	w/o LED taillights	E21	Easy	--
		16-18	70120	A, C, D, E, F	103	18"	32.5"	3.0						
Silverado 1500 LD	--	19-19	70120	A, C, D, E, F	103	18"	32.5"	3.0	19-19	58967	w/o LED taillights	E21	Easy	--
Silverado 1500 LTD	Excluding 2.7L	22-22	70141	A, C, F	99	21"	31.25"	3.0	22-22	58984	--	E25	Easy	--
	--	22-22	70146	A, C, F	89	19.5"	18"	3.0						
Silverado 2500 HD	--	15-19	70131*	C, F	103	18"	32.5"	1	16-19	58967	w/o LED taillights	E21	Easy	--
Silverado 3500 HD	--	15-19	70131*	C, F	103	18"	32.5"	1	16-19	58967	w/o LED taillights	E21	Easy	--
Sonic	--	12-20	70116	A, C, D, E, I	103	13.5"	18"	2.0	12-16	58936	--	E19	Easy	--
Suburban	Excl. Z71 or diesel	21-24	70145	C, E, G	89	19.5"	19"	4.0	21-24	58985	--	E25	Mod.	--
	Z71	21-24	70146	A, C, F	89	19.5"	18"	3.0						
	Excluding Z71 or adaptive cruise	15-20	70111	A, C, D, E	98	17.5"	32.5"	3.0						
	Z71, excluding adaptive cruise	15-20	70120	A, C, D, E, F	103	18"	32.5"	3.0						
Tahoe	Excl. Z71 or diesel	21-24	70145	C, E, G	89	19.5"	19"	4.0	21-24	58985	--	E25	Mod.	--
	Z71	21-24	70146	A, C, F	89	19.5"	18"	3.0						
	Excluding Z71 or adaptive cruise	15-20	70111	A, C, D, E	98	17.5"	32.5"	3.0						
	Z71, excluding adaptive cruise	15-20	70120	A, C, D, E, F	103	18"	32.5"	3.0						
Traverse	Excluding adaptive cruise	19-21	70136*	A, C, D, E	103	16"	37.5"	3.0	--	--	--	--	--	--
Dodge														
Durango	--	11-13	70101	A, C, D, F, G	98	17.5"	34.75"	3.0	11-13	58959	--	E23	Easy	58920
Ram 2500	--	03-10	70142*	B, D, E	99	25.5"	24"	2.0	--	--	--	--	--	--
Ram 3500	--	03-10	70142*	B, D, E	99	25.5"	24"	2.0	--	--	--	--	--	--

TOW BAR BASE PLATE APPLICATION GUIDE FOOTNOTE KEY

A Frame drilling required	C Baseplate concealed	E Concealed trimming required	G Permanent part removal	I Vehicle component mods or relocation
B Baseplate exposed	D Visible trimming required	F Tow hook removal required	H Rivet removal and replacement required	J Mounts to factory tow loop

For the most up-to-date application information, please visit curtmfg.com

* Continued while supplies last



TOW BAR BASE PLATES

Installation may be too difficult for some users. Visit curtmfg.com/storelocator to find an installer. Always consult your vehicle owner's manual for proper flat towing procedures and limitations. Never exceed the recommended gross vehicle weight rating (GVWR).

RV HARNESSSES

Add-On
#58919 - non-powered converter add-on compatible
#58920 - powered converter add-on compatible

Make / Model	Style / Notes	Years	Part #	Foot Notes	PC	Tab Ht.	Tab Width	Ins Time (hrs)	Years	Part #	Foot Notes	PC	Ins Diff.	Add-On #
Ford														
Bronco	Modular or standard D-ring bumper only	21-24	70143	A, C, I	89	28"	31"	3	21-24	58992	w/ LED taillights	E28	Mod.	--
	Standard bumper	21-24	70147	C, E, F	99	19.5"	30.5"	3		58996	w/o LED taillights	E24	Mod.	
	Heavy duty modular bumper	21-21	70140	C, J	39	26"	22"	0.5						
Edge	Excl. 2.0L EcoBoost	15-18	70125*	A, C, D, E, I	103	17.25"	24"	5.0	--	--	--	--	--	--
Expedition	--	18-22	70139	A, C, E, F	103	16"	34.5"	3.0	07-17	58988	--	E25	Easy	--
		15-17	70130	A, C, F, G	103	17.5"	35"	3.0						
			70106*	A, C, F, G	103	17.5"	35"	3.0						
Explorer	--	16-19	70114	A, C, D, E	103	16.5"	22"	3.0	16-19	58976	--	E19	Mod.	--
F-150	Excl. Lightning	09-23	70130	A, C, F, G	103	19"	33.5"	3.0	21-23	52103	w/ LED taillights	E25	Easy	--
	--	09-20	70106*	A, C, F, G	103	17.5"	35"	3.0	21-23	58989	w/ backup sensors, excl. LED taillights	E24	Easy	--
									15-18	58970	--	E22	Easy	--
									09-14	58912	--	E30	Easy	--
F-250 / F-350 Super Duty	--	20-24	70133	C, D	103	17.25"	24"	2.0	23-24	52106	w/o taillights	E27	Easy	--
		17-19	70137	A, C, E, F	103	24.5"	34.5"	3.0	21-22	52102	w/ backup sensors	E23	Easy	--
									20-22	58987	Excl. rear sensors and LED taillights	E24	Easy	--
									17-19	58987	--	E24	Easy	--
Fiesta	--	14-19	70119*	A, C, D, E, I	103	22"	24"	3.0	14-19	58977*	Sedan	E19	Mod.	58919*
										58972	Hatchback	E24	Mod.	58919*
Flex	--	13-19	70135*	A, C, E	103	15"	20"	3.0	--	--	--	--	--	--
Focus	Excluding RS	16-18	70113*	A, C, D, E	103	13.5"	21.5"	3.0	12-18	58944	Sedan	E25	Easy	--
Ranger	--	19-23	70127	C, F, G	98	17"	31"	1.0	19-22	58986	w/ blind spot detect	E25	Easy	--
GMC														
Acadia	--	17-19	70118	A, C, D, E	103	16"	20"	3.0	17-19	58973*	--	E25	Easy	--
		13-16	70124*	A, C, D, E, I	103	17.75"	18"	3.0	13-16	58908	--	E35	Mod.	--
Acadia Limited	--	17-17	70124*	A, C, D, E, I	103	17.75"	18"	3.0	17-17	58908	--	E35	Mod.	--
Canyon	--	15-22	70144	C, G	98	13.5-17"	30.5"	3.5	15-22	58910	--	E21	Easy	--
		15-20	70107*	C, E, G, I	103	23"	28"	3.5						
Sierra 1500	Excluding 2.7L	19-24	70141	A, C, F	99	21"	31.25"	3.0	19-24	58984	--	E25	Easy	--
	--	16-18	70120	A, C, D, E, F	103	18"	32.5"	3.0	16-18	58967	w/o LED taillights	E21	Easy	--
Sierra 1500 Limited	Excluding 2.7L	22-22	70141	A, C, F	99	21"	31.25"	3.0	22-22	58984	--	E25	Easy	--
	--	19-19	70120	A, C, D, E, F	103	18"	32.5"	3.0	19-19	58967	w/o LED taillights	E21	Easy	--
Sierra 2500 HD / 3500 HD	--	15-19	70131*	C, E, F	103	18"	32.5"	1	16-19	58967	w/o LED taillights	E21	Easy	--

TOW BAR BASE PLATE APPLICATION GUIDE FOOTNOTE KEY

A Frame drilling required **C** Baseplate concealed **E** Concealed trimming required
B Baseplate exposed **D** Visible trimming required **F** Tow hook removal required

For the most up-to-date application information, please visit curtmfg.com

G Permanent part removal **I** Vehicle component mods or relocation
H Rivet removal and replacement required **J** Mounts to factory tow loop

* Continued while supplies last



TOW BAR BASE PLATES

Installation may be too difficult for some users. Visit curtmfg.com/storelocator to find an installer. Always consult your vehicle owner's manual for proper flat towing procedures and limitations. Never exceed the recommended gross vehicle weight rating (GVWR).

RV HARNESSES

Add-On
#58919 - non-powered converter add-on compatible
#58920 - powered converter add-on compatible

Make / Model	Style / Notes	Years	Part #	Foot Notes	PC	Tab Ht.	Tab Width	Ins Time (hrs)	Years	Part #	Foot Notes	PC	Ins Diff.	Add-On #
GMC (continued)														
Terrain	--	10-17	70109	A, C, D, E, G, I	103	15.5"	24"	3.0	10-17	58900	--	E21	Easy	--
Yukon	Excluding AT4 or diesel	21-24	70145	C, E, G	89	19.5"	19"	4.0	21-24	58985	--	E25	Mod.	--
	AT4	21-24	70146	A, C, F	89	19.5"	18"	3.0	15-20	58965	--	E29	Easy	--
	Excluding Z71 or adaptive cruise	15-20	70111	A, C, D, E	98	17.5"	32.5"	3.0						
Yukon XL	Excl. AT4 or diesel	21-24	70145	C, E, G	89	19.5"	19"	4.0	21-24	58985	--	E25	Mod.	--
	AT4	21-24	70146	A, C, F	89	19.5"	18"	3.0	15-20	58965	--	E29	Easy	--
	Excluding Z71 or adaptive cruise	15-20	70111	A, C, D, E	98	17.5"	32.5"	3.0						
Honda														
CR-V	--	12-14	70104	C, D, E, G, I	103	15.5"	24"	2.0	12-16	58904	--	E21	Mod.	--
		07-11	70115	A, C, E, I	103	16"	19"	3.0	07-11	58901	--	E21	Mod.	--
Jeep														
Cherokee	Aluminum bumper w/o tow hooks	19-23	70132	C, D, G, H	103	19.5"	37"	3.0	19-23	58963	--	E23	Easy	--
	Steel bumper with tow hooks	19-23	70103	C, F, G, H	103	21"	37.5"	2.0						
	Trailhawk	14-18	70134	C, E, F, H	103	20"	37.25"	3.0	14-18	58909	--	E27	Mod.	58920
Gladiator	--	20-23	70129	A, B, E	103	17.25"	24"	3.0	20-24	58964	--	E29	Mod.	--
Grand Cherokee	--	11-21	70101	A, C, D, F, G	98	17.5"	34.75"	3.0	14-21	58907	--	E21	Mod.	--
									07-13	58940*	--	E31	Easy	--
Grand Cherokee WK	--	22-22	70101	A, C, D, F, G	98	17.5"	34.75"	3.0	22-22	58907	--	E21	Mod.	--
Wrangler	JL	18-24	70105	A, B, E	103	18"	24"	2.0	18-24	58964	JL	E29	Easy	--
	JK, excl. Rubicon, Hard Rock, 75th Anny & ARB bump.	07-18	70102	A, B, E	98	14.5"	24"	2.0	07-18	58903	JK, excl. right hand drive	E27	Easy	58919*
	JK, excl. std bump.	07-18	70110	A, B, E	103	17"	24"	2.0						
	TJ	97-06	70112	A, B	103	17.75"	24"	2.0	97-06	58902	--	E26	Easy	58919*
Lincoln														
Navigator	--	18-24	70139	A, C, E, F	103	16"	34.5"	3.0	--	--	--	--	--	--
		15-17	70130	A, C, F, G	103	17.5"	35"	3.0						
			70106*	A, C, F, G	103	17.5"	35"	3.0						
MKS	--	13-15	70135*	A, C, E	103	15"	20"	3.0	--	--	--	--	--	--
MKT	--	13-19	70135*	A, C, E	103	15"	20"	3.0	10-19	58960	--	E26	Mod.	--
MKX	--	16-18	70125*	A, C, D, E, I	103	17.25"	24"	5.0	--	--	--	--	--	--
Ram														
1500	--	16-18	70121	A, C, E	103	17.5"	35"	1.0	13-18	58916	Excl. LED taillights	E26	Mod.	--
										58906	w/ LED taillights	E25	Mod.	--
1500 Classic	--	19-24	70121	A, C, E	103	17.5"	35"	1.0	19-24	58916	Excl. LED taillights	E26	Mod.	--
										58906	w/ LED taillights	E25	Mod.	--
2500	--	11-18	70142*	B, D, E	99	25.5"	24"	2.0	13-18	58994	--	E24	Mod.	--
3500	--	11-18	70142*	B, D, E	99	25.5"	24"	2.0	13-18	58994	--	E24	Mod.	--

TOW BAR BASE PLATE APPLICATION GUIDE FOOTNOTE KEY

A Frame drilling required **C** Baseplate concealed **E** Concealed trimming required
B Baseplate exposed **D** Visible trimming required **F** Tow hook removal required

For the most up-to-date application information, please visit curtmfg.com

G Permanent part removal **I** Vehicle component mods or relocation
H Rivet removal and replacement required **J** Mounts to factory tow loop

* Continued while supplies last

STEEL TOW BAR LOCK SET

- Secures tow bar, vehicle and RV attachment points
- Easy-to-operate, 1/4-turn lock activation
- Watertight dust cap prevents internal corrosion
- Includes six keys for added convenience



Lock set includes matching keys for convenience



Helps deter theft and tampering when left unattended



70005

Part #	Fits Tube Size	Hitch Pin Diameter	Tow Bar Arm Lock Pin Diameter	Finish	Includes
70005	Up to 2-1/2"	5/8"	1/2"	Chrome-plated	Two tow bar arm locks and one hitch lock



2
INCH

HIGH-LOW HITCH RECEIVER ADAPTERS

- Fits industry-standard 2" hitch receiver tubes and accepts 2" shanks
- Ideal for leveling a tow bar with vehicle base plates



45797



45798



45808

Part #	Shank Size	Accepts	GTVW	Drop	Rise	Length	Finish
45797	2"	2" shank	7,500 lbs.	2"	2"	8"	Gloss black
45798	2"	2" shank	7,500 lbs.	4"	4"	8"	Gloss black
45808	2"	2" shank	7,500 lbs.	6"	6"	8"	Gloss black

RAMBLER™ TOW BAR COVER

- Acts as a storage bag when not in use
- Durable construction featuring UV-resistant vinyl and zipper
- Weather-resistant, form-fitted cover designed for use with CURT Rambler tow bar
- Shank fits within the cover when tow bar is folded



70010

Part #	Fits
70010	CURT Rambler tow bar (70001)

TOWING ACCESSORIES STORAGE BAG

- Great for chains, straps, greasy gooseneck ball and safety chain attachments
- Durable fabric with high-strength webbing straps
- Zipper closure to keep items secure
- Comfort-grip handles for easy portability



70004

Part #	Inside Length	Inside Width	Inside Depth
70004	15"	8"	8"

TOW BAR & BASE PLATE REPLACEMENT PARTS

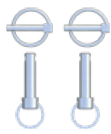

19261



19262



70002



70006



70008

Part #	Description	Break Strength	Length	Cable Diameter	Hook Opening
19261	Tow bar pins and lynch pins, qty 2	--	--	--	--
19262	Tow bar rubber bellow, qty 2	--	--	--	--
70002	Tow bar attachment tab, qty 1	--	7-3/4"	--	--
70003	Tow bar attachment tab, qty 1	--	9-1/4"	--	--
70006	Tow bar base plate safety cable, qty 1	3,500 lbs.	36"	1/4"	--
70007	Tow bar base plate safety cable, qty 1	7,500 lbs.	36"	3/8"	--
70008	Tow bar safety cable, qty 1	7,500 lbs.	84"	3/8"	17/32"



Attachment tabs seamlessly blend a factory appearance when not in use

UNIVERSAL TOW BARS

- Ideal for dingy towing a small vehicle behind an RV
- Lightweight design for easy handling
- Universal brackets bolt to the frame of the vehicle (trimming may be required)
- Includes universal frame brackets and mounting hardware
- Compact, retail-friendly packaging (#19750)
- Cannot be used with CURT base plates



19750



19745

Adjustable arm width allows for fitment on a variety of vehicles

Part #	Capacity	Arm Structure	Adjustment Range	Ball Diameter	Finish
19750	5,000 lbs.	Two pieces, bolt together	26" to 40" in width	2"	Gloss black
19745*	5,000 lbs.	One-piece	26" to 41" in width	2"	Gloss black

* Continued while supplies last

Replacement Parts

Part #	Description	Fits
19746	Replacement safety pin (new style)	19745
21500	Replacement pin & clip (old style)	19745
19748	Bumper brackets	19745



19746



21500



19748

EXTENDED VIEW TOW MIRROR

- Compatible with pickup or SUV left or right side mirror
- Fully adjustable design can be used in horizontal or vertical position
- Hinging arm and elastic straps provide easy and secure installation



Attaches to side mirror to expand view with a trailer



Articulating head allows precise angling



20002

Part #	Adds	Fits
20002	5" to 7-1/2" to existing mirror	Mirrors 4" to 11" high

TOWING LIGHTS

- Easily adds tow lights to a dinghy-towed vehicle or trailer without lights
- Non-scratch magnetic base protects vehicle finish
- Perfect for boats, RVs and flat towing applications
- 20' cord with 4-way flat plug allows for plug-and-play convenience
- Snap locks included for simple, secure splice-in connection
- Patent# D355,270



53204

53200

Bulk #	Pkg #	Length	Plug	Description
	53204*	20'	4-way flat	Auxiliary towing lights

* Includes a sturdy, reusable case

FUSE BYPASS SWITCHES

- Helps avoid having to remove and replace fuses when flat towing your vehicle
- Vehicle-specific application for a custom fit
- Integrates with CURT RV harness (sold separately)

Part #	Description	Max Amps
58435 N	Mini fuse bypass switch, short	20
58445 N	Mini fuse bypass switch, long	20
58455 N	Mini two-fuse bypass switch	20
58475 N	ATC two-fuse bypass switch	20

NEW



58435

58455

DINGHY TOWING ADAPTER HARNESES

- Plugs into CURT RV harness 4-flat to provide a standard connector concealed under the dinghy vehicle's hood
- Allows for flexible mounting on the front of the dinghy vehicle versus welded connector bracket
- 6' length is ideal for equipping dinghy vehicle for flat towing behind RV
- Some manual wiring required



Part #	From Dinghy Vehicle	To RV	Length	Material
58980	4-way flat	7-way RV blade	6 feet	Plastic
58981	4-way flat	6-way round	6 feet	Plastic

DINGHY TOWING ADAPTERS

- Ideal for connecting motorhomes to dinghy vehicle for flat towing
- UV-resistant coiled cable extends without scraping the ground
- Simple plug-and-play design eliminates the need for cutting or splicing
- Constructed from die-cast or durable plastic
- Informative, full-color, retail packaging



Part #	From Dinghy Vehicle	To RV	Extends	Included Socket	Socket Housing
57271	4-way flat	7-way RV blade	5 feet	--	Plastic
57280	4-way flat	7-way RV blade	8 feet	--	Plastic
57281	5-way flat	7-way RV blade	5 feet	--	Plastic
57282	5-way flat	7-way RV blade	8 feet	--	Plastic
57283	6-way round	7-way RV blade	8 feet	One 6-way round	Plastic and die cast
57284	7-way RV blade	7-way RV blade	8 feet	One USCAR 7-way RV blade	Plastic
57285	4-way round	7-way RV blade	8 feet	One 4-way round	Plastic and die cast
57286	6-way round	6-way round	8 feet	Two 6-way round	Die cast

TOW BAR RV HARNESSSES

For RV harness application
guide see page 240

- Integrated block diodes isolate sensitive vehicle electronics from RV signals
- Uses towed vehicle's existing taillights, brake lights and turn signals
- Optional harness add-on equips vehicle with standard 4-way flat for towing a trailer (not available for all RV harnesses; see table)



Connects a towed vehicle to an RV using a standard 4-way flat trailer plug



Simple plug-and-play design eliminates the need for cutting or splicing



Includes harness, 4-flat extension, mounting bracket and hardware

SPLICE-IN RV HARNESS

- Connects a towed vehicle to an RV using a standard 4-way flat trailer plug
- Splices into vehicle's electrical system with included butt connectors
- Validated color-coded wires with wiring guide for easier installation
- Integrated block diodes isolate sensitive vehicle electronics from RV signals
- Uses towed vehicle's existing taillights, brake lights and turn signals
- Not compatible with PWM electrical systems



Part #	Description
58979	Splice-in RV harness

RV HARNESS DIODE KIT

- Allows RV to power lights only on the towed vehicle without power feeding back
- Requires trailer-side 4-way flat plug with 20' wires or similar

Part #	Amps / Block	Volts / Block	Includes
58999	3 amps	24 volts max	Four diode blocks / 12 spade terminals



TOW BAR RV HARNESS APPLICATION GUIDE

Make / Model	Style	Years	Part #	Add-On #
Acura				
MDX	--	16 - 18	58955*	--
Buick				
Enclave	--	13 - 17	58908	58920
		08 - 12	58932*	58920
Envision	--	16 - 20	58968	--
Rainier	--	04 - 07	58925*	--
Cadillac				
Escalade	--	21 - 24	58993	--
		15 - 20	58965	--
		07 - 14	58927	--
Escalade ESV	--	21 - 24	58993	--
SRX	--	10 - 16	58978	--
Chevrolet				
Avalanche	--	07 - 13	58924*	58920
Captiva Sport	--	12 - 12	58933*	58920
Cobalt	Sedan, excl. SS	05 - 10	58931*	58920
Colorado	--	23 - 24	52108	--
		15 - 22	58910	--
		04 - 12	58926	58919*
Cruze	--	11 - 15	58935*	--
Cruze Limited	--	16 - 16	58935*	--
Equinox	Without LED taillights	22 - 24	58988	--
	With LED taillights	22 - 23	52105	--
	Without LED taillights	18 - 21	58971	--
	With LED taillights	18 - 21	58974	--
	--	10 - 17	58900	58920
Malibu	Excluding LTZ	13 - 15	58934*	--
		08 - 12	58932*	58920
Malibu Limited	Excluding LTZ	16 - 16	58934*	--
Silverado 1500	--	19 - 24	58984	--
	Without LED taillights	16 - 18	58967	--
Silverado 1500 LD	Without LED taillights	19 - 19	58967	--
Silverado 1500 LTD	--	22 - 22	58984	--
Silverado 2500 / 3500 HD	Excluding LED taillights w/ signature animation lighting	24 - 24	52107	--
	--	20 - 23	58984	--
	Without LED taillights	16 - 19	58967	--
Sonic	--	12 - 16	58936	--

Make / Model	Style	Years	Part #	Add-On #
Chevrolet (continued)				
Suburban	--	21 - 24	58985	--
		15 - 20	58966	--
Suburban 1500	--	07 - 14	58927	--
Tahoe	--	21 - 24	58985	--
		15 - 20	58966	--
		07 - 14	58927	--
Trailblazer	--	02 - 08	58925*	--
Traverse	--	13 - 17	58922*	58920
		09 - 12	58932*	58920
Dodge				
Caliber	--	08 - 12	58959*	--
Durango	--	14 - 24	58957	--
		11 - 13	58959*	--
Nitro	--	07 - 12	58937	58919*
Ram 1500	--	09 - 10	58916	--
Fiat				
500	--	12 - 19	58911	--
Ford				
Bronco	With LED taillights	21 - 24	58992	--
	Without LED taillights	21 - 24	58996	--
Edge	--	07 - 10	58952	58920
Escape	--	17 - 21	58954	--
		13 - 16	58943*	58920
		05 - 12	58952	58920
Expedition	--	07 - 17	58988	--
Explorer	--	16 - 19	58976	--
F-150	With backup sensors, excl. LED taillights	21 - 23	58989	--
	With LED taillights and backup sensors	21 - 23	52103	--
	With LED taillights, backup sensors, and onboard scale	21 - 23	52104	--
	Without LED taillights	15 - 18	58970	--
	--	09 - 14	58912	--
F-250 / F-350 Super Duty	Without LED taillights	23 - 24	52106	--
	With backup sensors	21 - 22	52102	--
	Excluding rear sensors and LED taillights	20 - 22	58987	--
	--	17 - 19	58987	--
Fiesta	Hatchback	14 - 19	58972*	--
		11 - 13	58946*	--
	Sedan	14 - 19	58977*	--

58919 - non-powered converter add-on compatible

58920 - powered converter add-on compatible

* Continued while supplies last

Make / Model	Style	Years	Part #	Add-On #
Ford (continued)				
Flex	--	09 - 19	58941*	58920
Focus	Hatchback	12 - 14	58905*	--
	Sedan	12 - 18	58944*	58920
Freestar	--	04 - 07	58952	58920
Fusion	--	13 - 20	58945*	58920
		06 - 12	58942*	58920
Ranger	w/ blind spot detection	19 - 24	58986	--
GMC				
Acadia	--	17 - 19	58973*	--
		13 - 16	58908	58920
Acadia Limited	--	17 - 17	58908	58920
Canyon	--	23 - 24	52108	--
		15 - 22	58910	--
		04 - 12	58926	58919*
Envoy	--	02 - 09	58925*	--
Sierra 1500	--	19 - 24	58984	--
	Without LED taillights	16 - 18	58967	--
Sierra 1500 Limited	--	22 - 22	58984	--
	Without LED taillights	19 - 19	58967	--
Sierra 2500 / 3500 HD	Excluding LED taillights w/ signature animation lighting	24 - 24	52107	--
	--	20 - 23	58984	--
	Without LED taillights	16 - 19	58967	--
Terrain	--	10 - 17	58900	58920
Yukon	--	21 - 24	58985	--
		15 - 20	58965	--
		07 - 14	58927	--
Yukon XL	--	21 - 24	58985	--
		15 - 20	58965	--
Yukon XL 1500	--	07 - 14	58927	--
Honda				
CR-V	--	12 - 16	58904	--
		07 - 11	58901	--
		02 - 06	58949	--
Element	--	07 - 11	58947*	--
Fit	--	07 - 13	58948*	58919*
Isuzu				
i-280	--	06 - 06	58926	58919*
i-290	--	07 - 08	58926	58919*
i-350	--	06 - 06	58926	58919*
i-370	--	07 - 08	58926	58919*
Jeep				
Cherokee	--	19 - 23	58963	--
		14 - 18	58909	58920
Compass	--	22 - 24	58997	--
		17 - 21	58958*	--
		11 - 16	58938*	58920
Gladiator	--	20 - 24	58964	--

Make / Model	Style	Years	Part #	Add-On #
Jeep (continued)				
Grand Cherokee	--	22 - 24	58998	--
		14 - 21	58907	--
		07 - 13	58940*	58920
		05 - 06	58939*	58919*
		99 - 04	58915	58919*
Grand Cherokee L	--	21 - 24	58998	--
Grand Cherokee WK	--	22 - 22	58907	--
Liberty	--	08 - 12	58937	58919*
		02 - 07	58917	58919*
Patriot	--	08 - 17	58959*	--
Wrangler	JL	18 - 24	58964	--
	JK, excl. right hand drive	07 - 18	58903	58920
	TJ	98 - 06	58902	58920
Lincoln				
Aviator	--	20 - 25	58983*	--
MKT	--	10 - 19	58960*	--
MKX	--	07 - 10	58952	58920
Mazda				
Tribute	--	08 - 11	58952	58920
Mercury				
Mariner	--	05 - 11	58952	58920
Oldsmobile				
Bravada	--	02 - 04	58925*	--
Pontiac				
G5	Sedan	07 - 10	58931*	58920
Pursuit	Sedan	05 - 06	58931*	58920
Ram				
1500	--	19 - 24	58975	--
	With LED Taillights	13 - 18	58906	--
	Without LED taillights	13 - 18	58916	--
	--	11 - 12	58916	--
1500 Classic	With LED Taillights	19 - 24	58906	--
	Without LED taillights	19 - 24	58916	--
2500 / 3500	With LED Taillights	19 - 24	58995	--
	--	13 - 18	58994	--
Saturn				
Vue	--	08 - 10	58933*	58920
		02 - 07	58928*	58919*
Subaru				
XV Crosstrek	--	13 - 15	58962*	--
Suzuki				
Grand Vitara	--	06 - 12	58950*	58919*
SX4	--	07 - 11	58950*	58919*
Toyota				
RAV4	--	13 - 18	58956*	--

58919 - non-powered converter add-on compatible

58920 - powered converter add-on compatible

* Continued while supplies last



GOOSENECK HITCHES

FEATURED PRODUCTS

Scan QR code for current applications or visit curtmfg.com



RockerBall™ gooseneck ball

RockerBall™ features ShockDrop™ technology to improve ride quality by reducing chucking and jarring, providing comfort for passengers.



Universal OEM offset balls

Improve the clearance between your truck bed and trailer with our CURT universal OEM puck system with gooseneck ball and 4" offset.



OEM-style hitches

CURT OEM-style hitches are designed for a custom fit on the latest Chevrolet, Ford, GMC, and Ram 2500 and 3500 pickup trucks.

PRODUCT INDEX

A B C



252
Selecting a Gooseneck



254
OEM Puck System Kits

256
Universal OEM Puck System Offset Balls



258
OEM-Style Hitches



260
Double Lock EZr™ Hitches



262
Original Double Lock™ Hitches



263
RockerBall™ Gooseneck Ball



266
Over-Bed Hitches



266
Fixed Ball Hitches



268
X5™ 5th Wheel Adapter Plates



269
5th Wheel Rail Hitches



270
Gooseneck Electrical

SELECTING A GOOSENECK HITCH

There are three basic methods for installing a gooseneck hitch:

A | OEM PUCK SYSTEM OPTIONS

Many pickups today are factory-equipped with a truck bed puck system. A puck system provides attachment points for both gooseneck and 5th wheel towing.

For trucks with a puck system, an OEM puck system gooseneck kit is the easiest way to tow a gooseneck trailer. The components can be installed or removed quickly, as necessary.

See page 254 to select one of these kits.

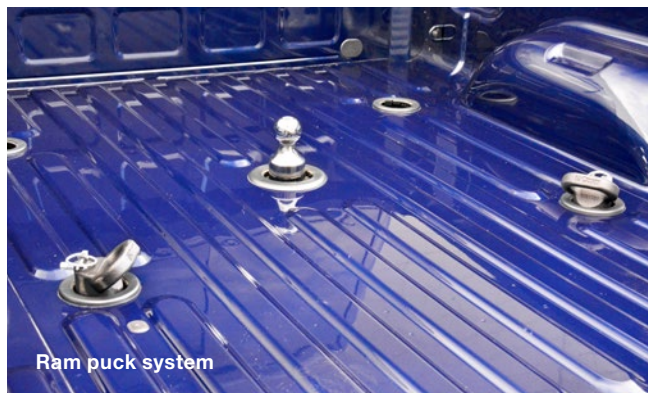

B | HITCH & BRACKET OPTIONS

The traditional method for installing a gooseneck hitch on trucks without factory-installed puck systems are vehicle-specific brackets. CURT OEM-style gooseneck hitches are a unique variant of the traditional method, featuring an all-in-one, custom-fit design that bolts to the truck frame like a factory hitch. No additional brackets required. See page 258 for our OEM-style hitches.

We also offer a variety of traditional gooseneck hitches that mount with vehicle-specific brackets. Options include our Double Lock EZr™, original Double Lock™ and more. Start on page 260 for our traditional gooseneck hitch line.



C | EXISTING 5TH WHEEL BASE RAIL OPTIONS

For trucks with 5th wheel rails already installed, CURT offers 5th wheel rail gooseneck hitches. These 5th-wheel-to-gooseneck adapters easily drop into any industry-standard base rails.

A 5th wheel rail hitch provides a ball ready for towing a gooseneck trailer, and the hitch can easily be removed from the rails whenever necessary to allow for 5th wheel towing or clearing the bed for cargo.

See page 268 for 5th wheel rail goosenecks.

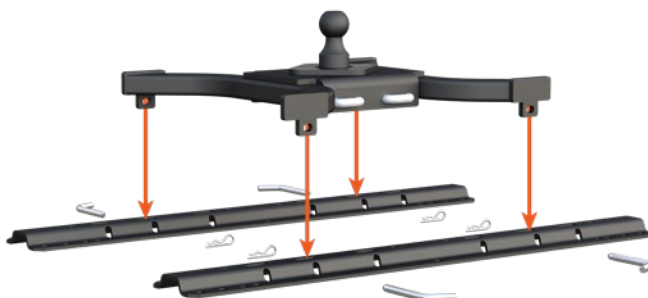



| OEM puck system anchor kit



| OEM-style hitches



| Bent plate hitch



OEM PUCK SYSTEMS

30K
GTW

38K
GTW

OEM PUCK SYSTEM GOOSENECK KITS

Available for Chevrolet, Ford, GMC, Nissan and Ram, these kits utilize the truck bed puck system built into select pickups with the factory installed towing prep package (see table below). The ball and anchors easily drop into the pucks, lock into place and are immediately ready to couple to a gooseneck trailer.

Each kit includes:

- 2-5/16" gooseneck ball
- Two safety chain anchors with zinc-plated locking pins
- Rubber hole cover
- Durable storage case



Quarter-turn anchoring system



Step 1 - Lift and twist latch to release the retention balls



Step 2 - Drop the ball into OEM puck system hole



Step 3 - Return latch to lock the ball in place for towing

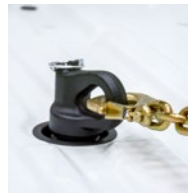

Large safety chain openings accept heavy-duty hooks



Installation of these products requires an OEM truck bed puck system (see above example, Ram puck system)

Product Details

Gooseneck ball

- Installs easily with quarter-turn latch locking system
- Kits include 2-5/16" (3" ball sold separately)
- Stainless steel bearing retention balls keep shank fully locked into the hitch
- Constructed from strong, machine-forged steel alloy
- Protected by a polished chrome-plated mirror finish
- Tested for safety to J2638 specifications (30K balls tested to U.S. VESC V-19)
- Patent #8,955,866

Safety chain anchors

- Provides a reliable connection for gooseneck trailer safety chains
- Simple, drop-in install eliminates the need for tools
- Wide openings accept large safety chain hooks
- Cast steel anchors with durable carbide black powder coat finish
- Patent #9,452,647

Make	Model	Style	Years
Kit Compatibility - See Adjacent Page for Part Numbers			
Chevrolet	Silverado 2500 HD / 3500 HD	With 5th wheel prep package	16 - 25
Ford	F-250 / F-350 Super Duty	With 5th wheel prep package	13 - 25
GMC	Sierra 2500 HD / 3500 HD	With 5th wheel prep package	16 - 25
Nissan	Titan XD	With 5th wheel prep package	16 - 24
Ram	2500 / 3500	With 5th wheel prep package	13 - 25



QUICK AND EASY DROP-IN INSTALLATION

OEM PUCK SYSTEM GOOSENECK KITS & COMPONENTS



60618
Ram



60638
Ram



60692 & 60639
Chevrolet, Ford, GMC, Nissan



60617 & 60698
Ram



60691
Chevrolet, Ford, GMC, Nissan



60601



60629
& 60627



60628
& 60634



66155

Make	GTW / Vertical Load	Ball Size	Rise	Kit #	Ball #	Anchors #	Cover #
30K Kits & Components							
Ram	30,000 / 7,500 lbs.	2-5/16"	1/2"	60618	60601	60617	66155
Chevrolet, Ford, GMC, Nissan	30,000 / 7,500 lbs.	2-5/16"	1-5/8"	60692	60629	60691	66155
Chevrolet, Ford, GMC, Nissan, Ram	30,000 / 7,500 lbs.	2-5/16"	1-5/8"	--	60629	--	--
Chevrolet, Ford, GMC, Nissan, Ram	30,000 / 7,500 lbs.	3"	1-5/8"	--	60628	--	--
38K Kits & Components							
Ram	38,000 / 9,500 lbs.	2-5/16"	1-5/8"	60638	60627	60698	66155
Chevrolet, Ford, GMC, Nissan	38,000 / 9,500 lbs.	2-5/16"	1-5/8"	60639	60627	60691	66155
Chevrolet, Ford, GMC, Nissan, Ram	38,000 / 9,500 lbs.	2-5/16"	1-5/8"	--	60627	--	--
Chevrolet, Ford, GMC, Nissan, Ram	38,000 / 9,500 lbs.	3"	1-5/8"	--	60634	--	--

Product Details

Fixed Ball and RockerBall™

- Provides extra 4" of rearward offset for improved turning and clearance
- Rated for up to 30,000 lbs. gross trailer weight and 7,500 lbs. vertical load
- Universal design fits Chevrolet, Ford, GMC, Nissan Titan XD and Ram puck systems (see application fitment in the table below)
- Adjustable anchors eliminate chucking between frame and pucks
- Anti-rotation arms provide stability and promote a smooth, steady tow
- Integrated safety chains holders
- Includes standard 2-5/16" diameter gooseneck ball with 4" rearward offset
- Provides 6-1/2" of rise over the factory OEM puck system
- Forged and machined steel gooseneck ball with yellow-zinc finish
- Frame protected by a highly durable carbide black powder coat finish
- Tested for safety in accordance with SAE J2638
- Patent pending

RockerBall™ specific

- ShockDrop™ technology promotes smooth towing by reducing jerking and jarring
- Cushioned isolator improves ride comfort for animals and passengers
- Offset pin dampens vertical chucking and fore-aft motion during starts and stops
- Virtually maintenance-free with no airbag or bearings to service
- Provides 8" of rise over the factory OEM puck system

Enhanced clearance

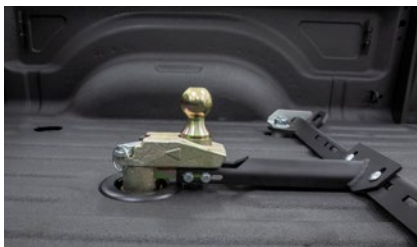

Provides an additional 4" of rearward offset and 6-1/2" of rise (8" for RockerBall)

Simple installation



Patented quarter-turn mechanism allows for quick, easy installation

ShockDrop™ (#60668 only)



ShockDrop technology reduces jerking and jarring and promotes a smooth tow

Make	Model	Style	Years
Compatibility - See Adjacent Page for Part Numbers			
Chevrolet	Silverado 2500 HD / 3500 HD	With 5th wheel prep package	20 - 25
Ford	F-250 / F-350 Super Duty	With 5th wheel prep package	13 - 25
GMC	Sierra 2500 HD / 3500 HD	With 5th wheel prep package	20 - 25
Nissan	Titan XD	With 5th wheel prep package	16 - 24
Ram	2500 / 3500	With 5th wheel prep package	13 - 25



PROVIDES AN EXTRA 4" OF REARWARD OFFSET

30k
GTW

**UNIVERSAL OEM PUCK SYSTEM
OFFSET GOOSENECK BALLS**

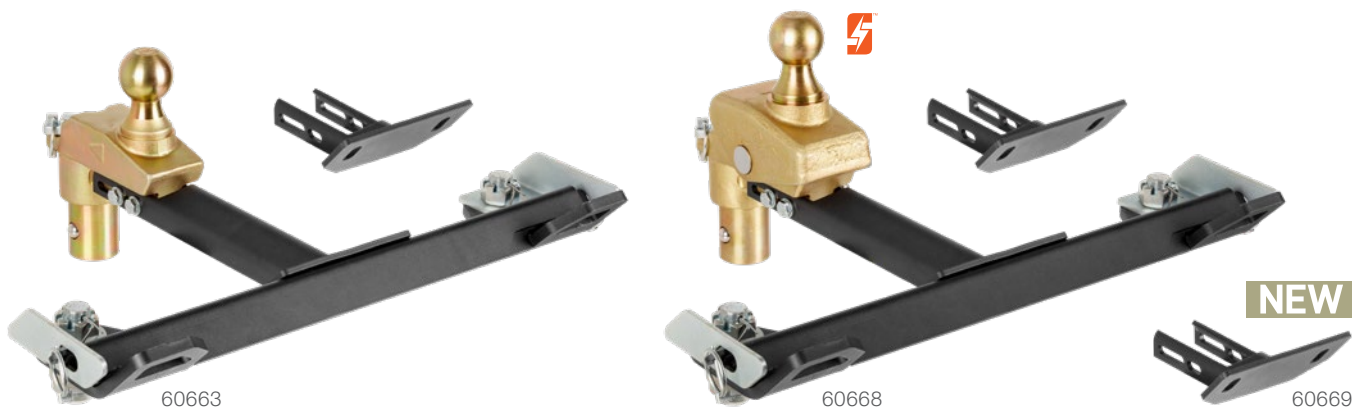

Part #	Ball Style	GTW / Vertical Load	Ball Size	Rise	Offset
60663	Fixed	30,000 / 7,500 lbs.	2-5/16"	6-1/2"	4"
60668	RockerBall	30,000 / 7,500 lbs.	2-5/16"	8"	4"
60669	N Compatible with #60663 and #60668				



NO ADDITIONAL HARDWARE OR BRACKETS REQUIRED

HITCHES & BRACKETS



OEM-STYLE GOOSENECK HITCHES

OEM-style gooseneck hitches are designed for a unique, vehicle specific fit for trucks not equipped with factory-installed puck systems. They quickly and securely bolt onto the truck's frame like a factory trailer hitch, with no drilling or additional parts required.

Streamlined installation



Requires no additional hardware or installation brackets



No drilling necessary except the truck bed holes



Requires no welding, bed flange trimming or bed removal

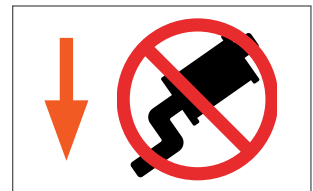

No lowering of exhaust or spare tire on #60702 and #60633

Product Details

- Center locator eliminates the need to measure where the ball hole should be
- Easy, one-person installation
- Quickly bolts on underneath the truck bed in 45 minutes or less (#60614, #60626)
- Places ball in front of rear axle for proper distribution of weight and handling (#60702, #60642)
- U-edging provided for a clean finish on the hole cut for the ball (#60702, #60642)
- Included patented 2-5/16" ball operates with a simple, quarter-turn latch-locking system to eliminate the need for an under-bed side handle
- Heavy-duty 5/8" spring-loaded safety chain loops for a reliable connection
- Tested for safety in accordance with SAE J2638
- Not compatible with X5 adapters or #60654 RockerBall
- Highly durable, rust-resistant, liquid A-coat finish
- **Not compatible with 5th wheel prep packages**



OEM-STYLE GOOSENECK HITCHES



60626 Ram



60614 Ram



60702 Ford



60633 Ram



60642 Chevrolet / GMC

Make / Model	Style	Years	Part #	GTW / Vertical Load
Chevrolet				
Silverado 2500 HD	--	20 - 25	60642	38,000 / 9,500 lbs.
Silverado 3500 HD	Excluding Cab & Chassis	20 - 25	60642	38,000 / 9,500 lbs.
Ford				
F-250 Super Duty	--	17 - 25	60702	38,000 / 9,500 lbs.
F-350 Super Duty	Excluding Cab & Chassis	17 - 25	60702	38,000 / 9,500 lbs.
F-450 Super Duty	Excluding Cab & Chassis	17 - 22	60702	38,000 / 9,500 lbs.
GMC				
Sierra 2500 HD	--	20 - 25	60642	38,000 / 9,500 lbs.
Sierra 3500 HD	Excluding Cab & Chassis	20 - 25	60642	38,000 / 9,500 lbs.
Ram				
2500	Excluding Cab & Chassis	19 - 25	60633	35,000 / 8,750 lbs.
		14 - 18	60614	30,000 / 7,500 lbs.
3500	Excluding Cab & Chassis	19 - 25	60633	35,000 / 8,750 lbs.
		13 - 18	60626	30,000 / 7,500 lbs.

Not compatible with 5th wheel prep packages

Quarter-turn gooseneck ball

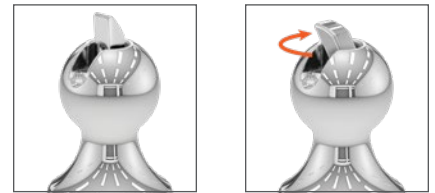

Factory-style gooseneck ball operates with a simple, 1/4-turn latch-locking system



Patented Center Locator eliminates measuring where the ball hole should be. Simply drill up from under the truck bed

30k
GTW

DOUBLE LOCK EZR™ GOOSENECK HITCH SYSTEM

Product Details & Operation

- Center tested up to 30,000 lbs. GTW and 7,500 lbs. vertical load
- Weight ratings are limited to vehicle manufacturer's stated capacities
- Includes 2-5/16" chrome-plated ball, 5/8" spring-loaded, zinc-plated safety chain loops and grade-8 hardware
- Protected by a durable A-coat finish with carbide black powder coat
- Tested for safety in accordance with SAE J2638



Engage the double locking pins for superior pin strength



Retract the sturdy 3/8" handle and drop the ball into the hole



After towing, flip the ball over to eliminate obstructions



Install the hole cover to protect the ball from the elements

What Makes the EZr™ Different?

One-person installation



Easy-to-install clips eliminate the need for a second person to hold up the center section while installing the brackets

- Uses carriage bolts when possible for one-wrench tightening
- No need to lower exhaust on Chevrolet, Ford, GMC and most Dodge / Ram models
- No need to relocate cable hanger and ground wire on Dodge / Ram models

No measuring required



Patented Center Locator eliminates the need to measure where the ball hole should be. Simply drill up from under the truck bed

- Safety chain loop holes are drilled from the underside of the truck bed
- No welding or truck bed removal required
- Center Locator covered by patent #D685,299 S

How is the EZr™ Installed Without Measuring?



Step 1 - Place Center Locator in the gooseneck hitch ball hole



Step 2 - Fully install brackets and hitch to the vehicle frame



Step 3 - Use Center Locator to drill pilot hole to drill pilot hole up from under bed



Step 4 - Use pilot hole to drill down, no measuring required

DOUBLE LOCK EZR™ GOOSENECK HITCH SYSTEM

If a particular application is not listed below,
see page 259 for OEM-style hitches or page 264 for original Double Lock™ hitches

Make / Model	Style	Years	Capacity	EZr Kit #	Footnotes	Hitch #	Bracket #
Chevrolet / GMC							
Silverado 2500	Excl Cab & Chassis	01 - 04	30,000 lbs.	60681	●	60619	60648
Silverado 2500 HD	--	20 - 25	25,000 lbs	60690	●	60611	60701
		11 - 19	30,000 lbs.	60680	●,1	60611	60624
		01 - 10	30,000 lbs.	60681	●	60619	60648
Silverado 2500 HD Classic	Excl Cab & Chassis	07 - 07	30,000 lbs.	60681	●	60619	60648
Silverado 3500	Excl Cab & Chassis	01 - 06	30,000 lbs.	60681	●	60619	60648
Silverado 3500 Classic	Excl Cab & Chassis	07 - 07	30,000 lbs.	60681	●	60619	60648
Silverado 3500 HD	Excl Cab & Chassis	20 - 25	25,000 lbs	60690	●	60611	60701
		11 - 19	30,000 lbs.	60680	●,1	60611	60624
		08 - 10	30,000 lbs.	60681	●	60619	60648
Dodge							
Ram 2500 / 3500	Excl Cab & Chassis	03 - 10	30,000 lbs.	60682	●, 1, 2, 3	60619	60660
Ford							
F-250	--	99 - 99	30,000 lbs.	60685	●	60619	60647
F-250 Super Duty	--	11 - 16	30,000 lbs.	60683	●	60619	60645
		99 - 10	30,000 lbs.	60685	●	60619	60647
F-350 Super Duty	Excl Cab & Chassis	11 - 16	30,000 lbs.	60683	●	60619	60645
		99 - 10	30,000 lbs.	60685	●	60619	60647
GMC							
Sierra 2500	Excl Cab & Chassis	01 - 04	30,000 lbs.	60681	●	60619	60648
Sierra 2500 HD	--	20 - 25	25,000 lbs	60690	●	60611	60701
		11 - 19	30,000 lbs.	60680	●,1	60611	60624
		01 - 10	30,000 lbs.	60681	●	60619	60648
Sierra 2500 HD Classic	Excl Cab & Chassis	07 - 07	30,000 lbs.	60681	●	60619	60648
Sierra 3500	Excl Cab & Chassis	01 - 06	30,000 lbs.	60681	●	60619	60648
Sierra 3500 Classic	Excl Cab & Chassis	07 - 07	30,000 lbs.	60681	●	60619	60648
Sierra 3500 HD	Excl Cab & Chassis	20 - 25	25,000 lbs	60690	●	60611	60701
		11 - 19	30,000 lbs.	60680	●,1	60611	60624
		07 - 10	30,000 lbs.	60681	●	60619	60648
Ram							
2500	--	11 - 13	30,000 lbs.	60682	●, 1, 2, 3	60619	60660
3500	Excl Cab & Chassis	11 - 12	30,000 lbs.	60682	●, 1, 2, 3	60619	60660

1. Passenger-side wheel well flange must be bent for frame rail access
 2. Check inverted ball clearance with heavy loads on two-wheel drive

3. Exhaust may have to be permanently lowered on power wagon and Mega cab applications
 ● =No frame drilling required

30k
GTW

ORIGINAL DOUBLE LOCK™ GOOSENECK HITCHES

See page 264 for original
Double Lock application guide

- Flip-and-store ball keeps truck bed free of obstructions
- Installation requires no welding or truck bed removal
- Heavy-duty handle can be positioned on either side of the vehicle
- Rubber hole cover helps prevent corrosion in trailer ball hole
- Includes spring-loaded safety chain loops and grade-8 hardware
- Highly durable carbide black powder coat finish
- Branded, retail-friendly brown box (#60607)



Engage the double locking pins for superior pin strength



Retract the sturdy 3/8" handle and drop the ball into the hole



Chrome trim ring for a clean, professional finish

Part #	Make / Model	Years	Ball Size	Finish	GTW / Vertical Load
60607	Multiple applications for Chevrolet, Ford, GMC, Nissan, Ram See page 264 for full application listing	--	2-5/16"	Carbide black	30,000 / 7,500 lbs.
60615	Chevrolet Silverado 1500 & GMC Sierra 1500	07 - 18	2-5/16"	Carbide black	30,000 / 7,500 lbs.
	Chevrolet Silverado 1500 LD & GMC Sierra 1500 Limited	19 - 19			

ORIGINAL DOUBLE LOCK™ GOOSENECK BALLS

- 2-5/16" gooseneck balls rated up to 30,000 lbs. GTW and 7,500 lbs. vertical load



60602



60603

Part #	Description	For Use With
60602	2-5/16" offset ball moves pivot point 4" rearward for added cab clearance	Original Double Lock goosenecks only
60603	2-5/16" riser ball adds 1" clearance for trucks with plastic or rubber bed liners	Original Double Lock goosenecks only



30K
GTW

ROCKERBALL™ CUSHION HITCH GOOSENECK BALL

Product Details

- ShockDrop™ technology reduces jerking and jarring and promotes a smooth tow
- Virtually maintenance-free with no airbag or bearings to service
- Forged steel construction for dependable towing strength
- Durable carbide black powder coat finish on base and chrome plating on ball
- Heavy-duty plastic storage case keeps components on-hand whenever needed
- Tested for safety to meet SAE J2638 specifications
- Grease zerk fitting provides easy lubrication
- **Not compatible with OEM-style goosenecks**
- Patent pending



ShockDrop™ technology



The cushioned isolator improves ride comfort for animals and passengers

Advanced engineering

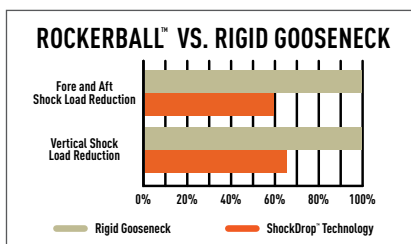

Offset pin dampens vertical chucking and fore-aft motion during starts and stops

Simple installation



Simple, drop-in installation easily replaces traditional gooseneck balls

Part #	Gooseneck Hitch Compatibility	GTW / Vertical Load	Ball Size	Rise
60654	CURT Double Lock Original, CURT EZr and most B&W gooseneck hitches*	30,000 / 7,500 lbs.	2-5/16"	6-1/2"

* For B&W models, hitch must accept gooseneck ball with 2" from the bottom of the shank to center of locking pin hole



30K
GTW

ORIGINAL DOUBLE LOCK™ GOOSENECK HITCHES

Make / Model	Style	Years	Footnotes	Kit # (Hitch and Brackets)	Hitch #	Bracket #
Chevrolet						
C/K 1500	--	88 - 99	●	60713	60607	60631
C/K 2500 / C3500	Excluding Cab & Chassis	88 - 00	●	60713	60607	60631
Silverado 1500	--	07 - 18	●	60711	60615	60632
		99 - 06	●	60712	60607	60652
Silverado 1500 Classic	--	07 - 07	●	60712	60607	60652
Silverado 1500 HD	--	01 - 06	●	60712	60607	60652
Silverado 1500 HD Classic	--	07 - 07	●	60712	60607	60652
Silverado 1500 LD	--	19 - 19	●	60711	60615	60632
Silverado 2500	Excluding Cab & Chassis	99 - 04	●	60712	60607	60652
Silverado 2500 HD	Excluding Cab & Chassis	11 - 19	●	60710	60607	60604
		01 - 10	●	60712	60607	60652
Silverado 2500 HD Classic	Excluding Cab & Chassis	07 - 07	●	60712	60607	60652
Silverado 3500	Excluding Cab & Chassis	01 - 06	●	60712	60607	60652
Silverado 3500 Classic	Excluding Cab & Chassis	07 - 07	●	60712	60607	60652
Silverado 3500 HD	Excluding Cab & Chassis	11 - 19	●	60710	60607	60604
		08 - 10	●	60712	60607	60652

All models: Brake, fuel and electrical lines may need to be loosened or repositioned. Heat shield requires modification or removal.

1. Passenger-side wheel well must be notched for frame rail access
2. Parking brake cable bracket may require relocation
3. Exhaust may have to be permanently lowered on 2005 and newer models
4. Ball cannot be turned over. Brake lines must be cable-tied (ties included)
5. Do not invert ball with heavy loads on two-wheel-drive models
6. ● = No frame drilling required



On two-wheel-drive trucks, a clearance check must be performed when truck is loaded and unloaded to verify the inverted ball will not interfere with the top of the differential. See footnote 6.

Make / Model	Style	Years	Footnotes	Kit # (Hitch and Brackets)	Hitch #	Bracket #
Dodge						
Ram 1500	--	09 - 10	●	60730	60607	60657
		02 - 08	●, 1, 2, 6	60733	60607	60659
		94 - 01	●	60734	60607	60635
Ram 2500 / 3500	Excluding Cab & Chassis	03 - 10	●, 1, 2, 6	60732	60607	60661
		94 - 02	●	60734	60607	60635
Ford						
F-150	Excl. Police Responder, Raptor, Lightning, or dual exhaust	22 - 23	●	60724	60607	60649
	Excl. Police Responder or Raptor	15 - 21	●	60724	60607	60649
	--	04 - 14	●	60721	60607	60641
		97 - 03	●	60722	60607	60637
		80 - 96	1	60723	60607	60636
F-150 Heritage	--	04 - 04	●	60722	60607	60637
F-250	Light Duty	97 - 99	●	60722	60607	60637
	Excluding Cab & Chassis	80 - 98	1	60723	60607	60636
F-250 Super Duty	--	99 - 16	●, 3	60720	60607	60644
F-350	Excluding Cab & Chassis	80 - 98	1	60723	60607	60636
F-350 Super Duty	Excluding Cab & Chassis	99 - 16	●, 3	60720	60607	60644
F-450 Super Duty	Excluding Cab & Chassis	08 - 12	●, 3	60720	60607	60644
GMC						
C/K 1500	--	88 - 99	●	60713	60607	60631
C/K 2500 / C3500	Excluding Cab & Chassis	88 - 00	●	60713	60607	60631
Sierra 1500	--	07 - 18	●	60711	60615	60632
		99 - 06	●	60712	60607	60652
Sierra 1500 Classic	--	07 - 07	●	60712	60607	60652
Sierra 1500 HD	--	01 - 06	●	60712	60607	60652
Sierra 1500 HD Classic	--	07 - 07	●	60712	60607	60652
Sierra 1500 Limited	--	19 - 19	●	60711	60615	60632
Sierra 2500	Excluding Cab & Chassis	99 - 04	●	60712	60607	60652
Sierra 2500 HD	Excluding Cab & Chassis	11 - 19	●	60710	60607	60604
		01 - 10	●	60712	60607	60652
Sierra 2500 HD Classic	Excluding Cab & Chassis	07 - 07	●	60712	60607	60652
Sierra 3500	Excluding Cab & Chassis	01 - 06	●	60712	60607	60652
Sierra 3500 Classic	Excluding Cab & Chassis	07 - 07	●	60712	60607	60652
Sierra 3500 HD	Excluding Cab & Chassis	11 - 19	●	60710	60607	60604
		07 - 10	●	60712	60607	60652
Ram						
1500	Coil springs, excluding Limited	11 - 18	●	60730	60607	60657
1500 Classic	Coil springs	19 - 24	●	60730	60607	60657
2500	--	11 - 13	●, 1, 2, 6	60732	60607	60661
3500	Excluding Cab & Chassis	11 - 12	●, 1, 2, 6	60732	60607	60661
Toyota						
Tundra	6.5' bed	07 - 21	●, 5	60751	60607	60667

All models: Brake, fuel and electrical lines may need to be loosened or repositioned. Heat shield requires modification or removal.

1. Passenger-side wheel well must be notched for frame rail access
 2. Parking brake cable bracket may require relocation
 3. Exhaust may have to be permanently lowered on 2005 and newer models
 4. Do not invert ball with heavy loads on two-wheel-drive models
 5. Ball cannot be turned over. Brake lines must be cable-tied (ties included)
 6. Do not invert ball with heavy loads on two-wheel-drive models
- = No frame drilling required

30k
GTW

OVER-BED FOLDING BALL GOOSENECK HITCH

See adjacent page for folding ball application guide

- Folding ball design keeps truck bed free of obstructions
- Stainless steel safety pin and pivot spring prevent binding
- Permanently attached gooseneck ball
- Includes safety chain loops and grade-8 hardware
- Patents: #5,571,270; #5,755,452; #5,435,585



61052

How Folding Ball Works

Open storage cover



Lift T-handle and drop ball



Close cover to store ball



Part #	Description	Plate Size	Ball Size	Finish	GTW / Vertical Load
61052	Folding ball gooseneck hitch	12" x 14"	2-5/16"	Carbide black	30,000 / 7,500 lbs.

30k
GTW

OVER-BED FIXED BALL GOOSENECK HITCHES

See adjacent page for fixed ball application guide

- Reinforcement required to reach max gross trailer weight rating



65500



61100

Part #	Description	Plate Size	Ball Size	Finish	GTW / Vertical Load
65500	Flat plate with fixed trailer ball and two 1/2" forged D-rings	13" x 48"	2-5/16"	Carbide black	30,000 / 7,500 lbs.
61100	Flat plate with fixed trailer ball (safety chain hook-ups sold separately)	12" x 12"	2-5/16"	Carbide black	30,000 / 7,500 lbs.



30K OVER-BED GOOSENECK APPLICATION GUIDE

GTW

- Up to 30,000 lbs. GTW (limited to vehicle capacities)
- Vehicle-specific design optimizes strength and installation time
- Constructed from high-strength, laser-cut steel for a precise fit
- Protected by a rust-resistant liquid A-coat
- Includes grade-8 mounting hardware



61301

Make / Model	Style	Years	Foot Notes	Folding Ball Hitch #	Fixed Ball Hitch #	Flat Plate Hitch #	Bracket #
Chevrolet / GMC							
Silverado / Sierra 1500	--	99 - 06	●	61052	61100	65500	61341
Silverado / Sierra 1500 Classic	--	07 - 07	●	61052	61100	65500	61341
Silverado / Sierra 2500	Excluding Cab & Chassis	99 - 04	●	61052	61100	65500	61341
Silverado / Sierra 2500 HD	--	11 - 19	●	61052	61100	65500	61301
		01 - 10	●	61052	61100	65500	61341
Silverado / Sierra 2500 HD Classic	--	07 - 07	●	61052	61100	65500	61341
Silverado / Sierra 3500	Excluding Cab & Chassis	01 - 06	●	61052	61100	65500	61341
Silverado / Sierra 3500 Classic	Excluding Cab & Chassis	07 - 07	●	61052	61100	65500	61341
Silverado / Sierra 3500 HD	Excluding Cab & Chassis	11 - 19	●	61052	61100	65500	61301
		07 - 10	●	61052	61100	65500	61341
Dodge							
Ram 1500	--	94 - 01	--	61052	61100	65500	61509
Ram 2500 / 3500	Excluding Cab & Chassis	94 - 02	--	61052	61100	65500	61509
Ford							
F-250 Super Duty	--	99 - 15	●	61052	61100	65500	61332
F-350 Super Duty	Excluding Cab & Chassis	99 - 15	●	61052	61100	65500	61332
F-450 Super Duty	Excluding Cab & Chassis	08 - 11	●	61052	61100	65500	61332

● = No frame drilling required

WELD-ON GOOSENECK BALL

- Constructed from high-strength, ready-to-weld SAE 51340 steel
- Heat-treated for optimum durability
- Tested to U.S. VESC V-5 specifications



Part #	GTW	Ball Size	Finish
40094	30,000 lbs	2-5/16"	Raw

20k GTW X5™ GOOSENECK TO 5TH WHEEL ADAPTER PLATES

The X5 adapter plate allows a gooseneck hitch to become a mounting platform for a 5th wheel hitch. The X5 shank simply drops into the gooseneck ball hole and instantly provides a set of industry-standard 5th wheel base rails. See the table below for gooseneck hitch compatibility.

For more information about mounting a 5th wheel hitch, see page 204.

Product Details

- Converts a gooseneck hitch into a set of standard 5th wheel base rails
- No assembly or tools required – just drop it in, lock it and go
- For use with CURT and competitor 5th wheels up to 20,000 lbs.
- Capacity limited to lowest-rated towing component
- Accepts any standard CURT 5th wheel legs or roller (excludes OEM puck system)
- Durable carbide black powder coat finish
- Co-cured in a rust-resistant liquid A-coat
- **Not compatible with OEM-style gooseneck hitches or turret-style pin boxes, such as Sidewinder™ or Turning Point™**
(Trademark of First Brands Group™)

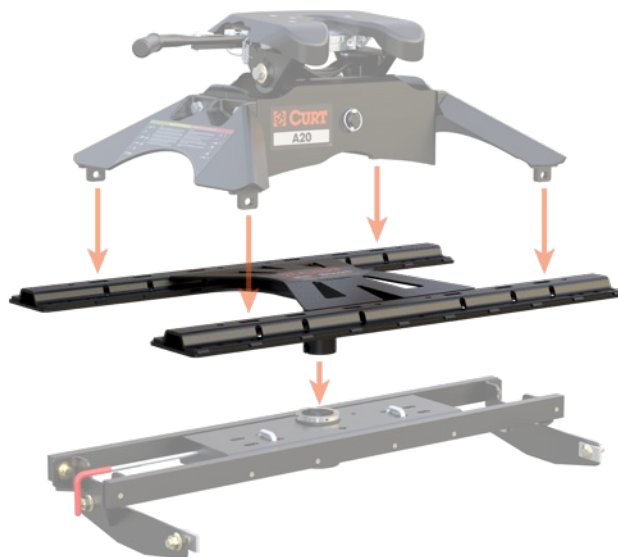

16210 - Fits CURT original Double Lock



16220 - Fits CURT Double Lock EZr



16310 - Fits B&W Turnoverball

Part #	Fits	Capacity	Shank Style
16210	CURT Double Lock 60607 and 60615	20,000 lbs.	Round shank
16220	CURT Double Lock EZr 60611 and 60619	20,000 lbs.	Round shank
16310	B&W Turnoverball® (excl. shallow models; shank hole is 2-1/4" from plate surface)	20,000 lbs.	Square shank

ADJUSTABLE GOOSENECK COUPLER

NEW

- Self-centering locking plate for easier hookup
- Adjustable length with 8" of adjustment (29-1/3" retracted height)
- Easy-access lock handle for secure connection
- Compatible with most round-tube trailer tongues
- Added material around pin holes to prevent hole elongation and reduce wear
- Quality steel construction for dependable towing strength
- Tested for safety to meet SAE J2638 specifications



Part #	GTW / TW	Ball Diameter	Inside Diameter	Outside Diameter	Finish
25030 N	30,000 lbs. / 9,000 lbs.	2-5/16"	4"	4-1/2"	Raw

5TH WHEEL RAIL OPTIONS

5TH WHEEL RAIL GOOSENECK HITCHES

See page 221 to select custom 5th wheel brackets

- Allows pickup trucks equipped with 5th wheel rails to tow gooseneck trailers
- Mounts to all industry-standard 5th wheel rails
- Four-pin installation and removal for easy truck bed access
- #16055 can be positioned over the axle or rotated to provide a 3" rearward offset
- Includes safety chain hookups, pins & clips
- Highly durable carbide black or teridium grey powder coat finish
- Tested for safety in accordance with SAE J2638
- Branded, retail-friendly brown box

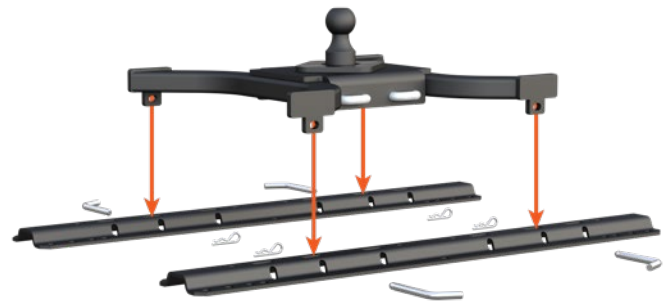

16090



16085



16055

Part #	Description	GTW	Ball Size	Finish
16090*	Spyder™ gooseneck hitch	30,000 lbs.	2-5/16"	Dark grey teridium
16085	Spyder™ gooseneck hitch	25,000 lbs.	2-5/16"	Carbide black
16055	Bent plate gooseneck hitch with 3" offset	25,000 lbs.	2-5/16"	Carbide black
23256	Base rail lock	--	--	Black powder-coated aluminum



* Requires base rail #16205 to reach 30K capacity, see page 221 for custom 5th wheel brackets and ratings

GOOSENECK ELECTRICAL

CUSTOM WIRING EXTENSION HARNESSSES

- Routes a 7-way RV blade socket into truck bed while retaining use of rear socket
- Simple plug-and-play design eliminates the need for cutting or splicing
- Allows for easy connection of gooseneck wiring
- Requires 2-1/8" hole saw for installation
- Neoprene well nuts isolate steel bolts from aluminum surfaces (select models)
- See page 162 for more information

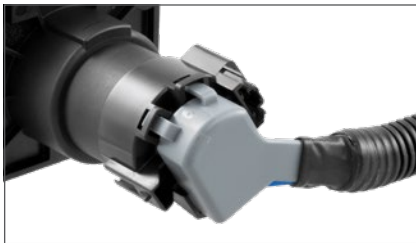

Right-angle plug for easy installation



7' routes socket into rear of the truck bed



10' routes socket closer to truck cab

7-WAY RV BLADE EXTENSION HARNESS

- Routes existing 7-way RV blade socket into full-size pickup truck bed (7' length)
- Universal size fits any 7-way RV blade socket
- Allows for easy connection of gooseneck wiring
- See page 164 for more information



REPLACEMENT 7-WAY RV BLADE HARNESSSES

- Replaces the trailer-end plug of any 7-way harness
- Wires protected by heavy-duty, weather-resistant cable
- Cold-weather harnesses feature soft thermoplastic elastomer casing to remain flexible in cold temperatures (temperature rating from -40°F up to 221°F)
- See page 165 for more information



BRAKE CONTROLLERS

For a full list of benefits see pages 144 - 147

- Easily calibrated for all towing needs
- Proportional and time-delay units available



51200

Echo® in-line
Hidden under vehicle
Bluetooth-enabled
Smartphone-ready



51190

Echo® under-dash
Hidden under dash
Bluetooth-enabled
Smartphone-ready



51180

Echo® mobile
Portable design
Bluetooth-enabled
Smartphone-ready



51170

Spectrum™
Integrated OE look
Hidden main body
Tri-color LED display



51146

TriFlex™ NEXT
Tri-axis sensitivity
Auto adjustment
Digital display



51126

Discovery™ NEXT
Time-delay
Adjustable output
Digital display



51116

Venturer™ NEXT
Time-delay
Adjustable output
Ramp-up LED display

Dynamic power adjustment

Applies to Echo, Spectrum, Assure and TriFlex



Automatic power reduction for incline

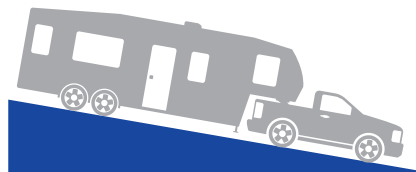

Automatic power increase for decline



Tri-axis circuit detects inertia on three planes for greater sensitivity over dual-axis models

Note: Values represented are for illustration only. The actual preset and adaptive values may differ from those shown here.

Name	Pkg #	6-Pack #	Axles	Brakes	Activation Method	Display	Mount Angle	Sleep Mode	Electric Over Hydraulic	Warranty
Echo in-line	51200	--	1 - 4	2 - 8	Proportional	Phone app	Any	Yes	No	Ltd lifetime
Echo under-dash	51190	--	1 - 4	2 - 8	Proportional	Phone app	Any	Yes	No	Ltd lifetime
Echo mobile	51180	--	1 - 2	2 - 4	Proportional	Phone app	Any	N/A	No	Ltd lifetime
Spectrum	51170	--	1 - 4	2 - 8	Proportional	Tri-color LED	Any	N/A	No	Ltd lifetime
TriFlex NEXT	51146	511466 N	1 - 4	2 - 8	Proportional	LED digital	Any	Yes	No	Ltd lifetime
Discovery NEXT	51126	511266 N	1 - 4	2 - 8	Time-delay	LED digital	Any	Yes	Yes	Ltd lifetime
Venturer NEXT	51116	511166 N	1 - 3	2 - 6	Time-delay	LED digital	Any	Yes	Yes	Ltd lifetime

REPLACEMENT PARTS

OEM PUCK SYSTEM KIT REPLACEMENT PARTS



Part #	Description	Fits
66155	Rubber puck hole cover	All puck system center holes
19250	Anchor pin & lynch pin, qty 1 (Fits Ram)	60617, 60618, 60638, 60698
19251	Anchor pin & lynch pin, qty 1 (Fits Chevrolet, Ford, GMC, Nissan)	60691, 60692, 60639, 60691

OEM-STYLE HITCH REPLACEMENT PARTS



Part #	Description	GTW / Vertical Load	Ball Size	Rise	Fits
66155	Rubber puck hole cover	--	--	--	All
60601	OEM-style ball	30,000 / 7,500 lbs.	2-5/16"	1/2"	All
60629	OEM-style ball	30,000 / 7,500 lbs.	2-5/16"	1-5/8"	All
60628	OEM-style ball	30,000 / 7,500 lbs.	3"	1-5/8"	All
60627	OEM-style ball	38,000 / 9,500 lbs.	2-5/16"	1-5/8"	All
60634	OEM-style ball	38,000 / 9,500 lbs.	3"	1-5/8"	All

ROCKERBALL™ GOOSENECK BALL REPLACEMENT PART

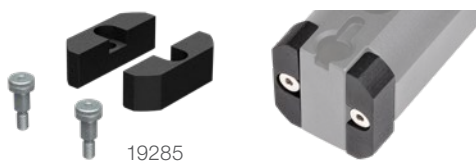

Part #	Description	Fits
19285	Adapter kit for B&W hitches	60654

EZR™ & ORIGINAL DOUBLE LOCK REPLACEMENT PARTS

Fig #	Part #	Description	Fits
1	19253	Center locator	EZr
2	19254	Safety chain U-bolt spring kit - 5/8" U-bolts, qty 2 - U-bolt spring, qty 4 - 5/8" flat washers, qty 8 - 5/8" nylock nuts, qty 4	EZr
3	19260	Safety chain U-bolt spring kit - 1/2" U-bolts, qty 2 - U-bolt spring, qty 4 - 1/2" flat washers, qty 8 - 1/2" nylock nuts, qty 4	Original
4	19255	Handle assembly - #10 hex flange screw, qty 1 - #10 nylock nut, qty 1 - Handle rod, qty 1 - Handle grip, qty 1	EZr & original
5	19256	Chrome trim ring with hardware	EZr & original
6	19257	Handle spring with two washers	EZr & original
7	19258	Locking pin with hardware	EZr & original
8	19259	5/16" cylinder guide pin	EZr & original
9	66165	Rubber hole cover	EZr & original
10	60616	Gooseneck ball, 2-5/16"	EZr & original

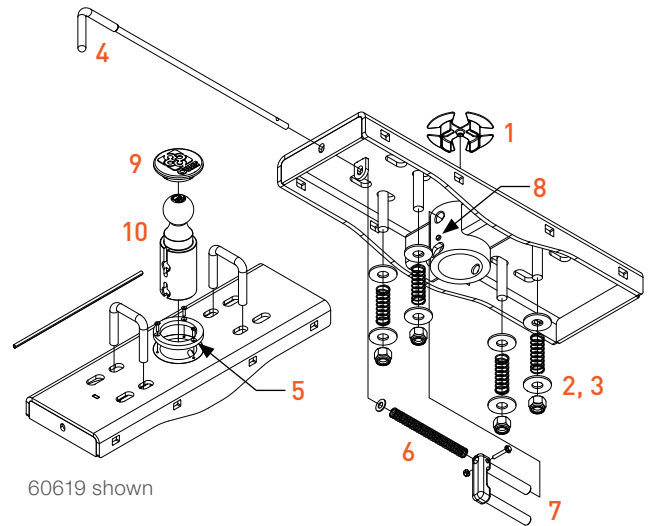

OVER-BED HITCH REPLACEMENT PARTS

Part #	Description	Fits
66123	T-handle	61052
19260	Safety chain U-bolt spring kit - 1/2" U-bolts, qty 2 - U-bolt spring, qty 4 - 1/2" flat washers, qty 8 - 1/2" nylock nuts, qty 4	61052
66113	Safety chain U-bolt spring kit - 5/8" U-bolts, qty 2 - U-bolt spring, qty 4 - M16 flat washers, qty 4 - 5/8" nylock nuts, qty 4	61100

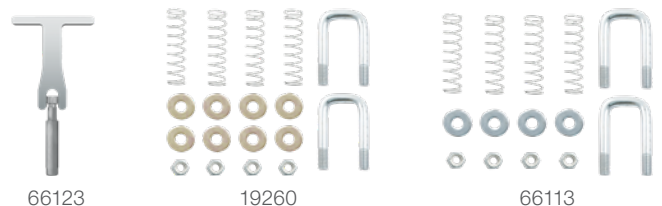

5TH WHEEL RAIL HITCH REPLACEMENT PARTS

Part #	Description	Fits
16902	Pin & clip, qty 4	16090, 16085, 16055





TRAILER PARTS & ACCESSORIES

FEATURED PRODUCTS



2-speed winches

Crafted from premium cold-forged steel, CURT 2-speed winches feature solid gears for unmatched reliability in harsh marine conditions.



Brake winches

Ideal for lifting and hoisting applications, CURT brake winches provide safe and reliable performance every time.



Lippert premium axle parts

We offer a complete range of premium replacement parts, expertly designed to meet the highest quality standards.

PRODUCT INDEX



276
Gooseneck
Coupler



276
QuickPin™
Couplers



277
Couplers &
Accessories



280
Channels &
Lunette Rings



284
Jacks &
Accessories



288
Hand Winches
& Straps



291
Cargo
Straps



292
Safety Chains
& Cables



295
Hooks
& Links



298
Rings & Tie-
Down Anchors

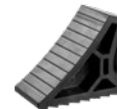

300
Wheel
Chocks



304
Premium
Axle Parts

ADJUSTABLE GOOSENECK COUPLER

- Self-centering locking plate for easier hookup
- Adjustable length with 8" of adjustment (29-1/3" retracted height)
- Easy-access lock handle for secure connection
- Compatible with most round-tube trailer tongues
- Added material around pin holes to prevent hole elongation and reduce wear
- Quality steel construction for dependable towing strength
- Tested for safety to meet SAE J2638 specifications



NEW

Part #	GTW / TW	Ball Diameter	Inside Diameter	Outside Diameter	Finish
25030 N	30,000 lbs. / 9,000 lbs.	2-5/16"	4"	4-1/2"	Raw

QUICKPIN™ NO-LATCH TRAILER COUPLERS

- Fastens securely with included hitch pin and clip (only compatible with included pin or accepted locks; see table)
- Lasso lanyard secures pin to coupler to avoid missing pieces
- 50° A-frame angle fits most A-frame trailers (#25474 only)
- Bolt-on or weld-on installation for versatile mounting options (trailer mounting hardware not included)
- Passes SAE J684 performance testing
- Patent pending
- **See page 302 for replacement parts**

See table below for accepted hitch locks



Latchless, one-pin coupling is easier to use than traditional couplers

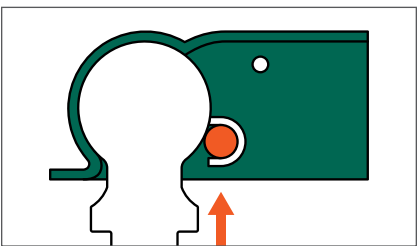

Innovative design allows fast, hassle-free trailer hookup with just one pin

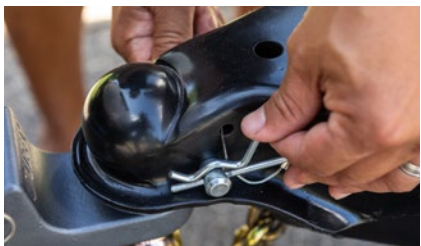

No jamming or complicated hinging components prone to wear or adjustments

Part #	Class	GTW / TW	Ball Size	Mounting Style	Finish	Accepted Locks (see page 117)
25470	2	3,500 / 350 lbs.	2"	2" channel	Gloss black	23020, 23024, 23501, 23517 and 23506
25471	2	3,500 / 350 lbs.	2"	2-1/2" channel	Gloss black	23020, 23024, 23501, 23517 and 23506
25472	2	3,500 / 350 lbs.	2"	3" channel	Gloss black	23020, 23024, 23501, 23517 and 23506
25474	4	14,000 / 1,400 lbs.	2-5/16"	A-frame (50°)	Gloss black	23021, 23025 (replace included 5/8" pin) 23022, 23521, 23546 (fit included pin hole)

STRAIGHT-TONGUE & A-FRAME COUPLERS

For a selection of coupler locks see pages 118 - 120

- Sleeve-lock latch system for optimum security (#25217, #25227)
- Spring and nut posi-lock mechanism allows for easy adjustment (select models)
- Can be used with a safety pin or coupler lock
- Constructed from high-strength steel
- Bolt-on or weld-on installation for easy mounting (trailer mounting hardware not included)
- Protected by a durable zinc-plated or gloss black powder coat finish
- Tested for safety in accordance with SAE J684
- **See page 302 for replacement parts**



25200



25105



25128



25131



25153



25135



25138



25100



25227



25217



25210



25101

Part #	Class	GTW / TW	Ball Diameter	Latch Style	Channel Width	Finish
Straight-Tongue Couplers						
25105	1	2,000 / 200 lbs.	1-7/8"	Posi-lock	2-1/2"	Zinc-plated
25128	1	2,000 / 200 lbs.	1-7/8"	Posi-lock	2"	Zinc-plated
25131	1	2,000 / 200 lbs.	1-7/8"	Posi-lock	3"	Zinc-plated
25153	2	3,500 / 500 lbs.	2"	Posi-lock	2"	Zinc-plated
25135	2	3,500 / 500 lbs.	2"	Posi-lock	2-1/2"	Zinc-plated
25138	2	3,500 / 500 lbs.	2"	Posi-lock	3"	Zinc-plated
25100	3	5,000 / 700 lbs.	2"	Posi-lock	3"	Zinc-plated
A-Frame Couplers						
25101	3	5,000 / 700 lbs.	2"	Posi-lock	--	Zinc-plated
25210	3	5,000 / 700 lbs.	2"	Posi-lock	--	Gloss black
25217*	4	7,000 / 1,050 lbs.	2"	Sleeve-lock	--	Gloss black
25200	4	10,000 / 1,500 lbs.	2-5/16"	Easy-lock	--	Gloss black
25227*	4	12,500 / 1,875 lbs.	2-5/16"	Sleeve-lock	--	Gloss black

* Solid neck for increased strength and greater corrosion resistance



Spring and nut posi-lock mechanism allows for easy adjustment (select models)

CHANNEL-MOUNT COUPLERS

For a selection of coupler locks see pages 118 - 120

- Compatible with CURT channels #48610 and #48650, see page 280
- Secured by a dual-bolt mounting system
- Channel-mount allows for easy height adjustment
- Safety pin hole can also accept a coupler lock
- Constructed from heavy-duty cast steel
- Protected by a durable black powder coat finish
- **See page 302 for replacement parts**



Part #	GTW / TW	Ball Diameter	Latch Style
25319*	7,000 / 1,050 lbs.	2"	Sleeve-lock
25329*	12,500 / 1,875 lbs.	2-5/16"	Sleeve-lock
25330	14,000 / 2,100 lbs.	2-5/16"	Easy-lock
25328	15,000 / 2,250 lbs.	2-5/16"	Easy-lock

* Solid neck for increased strength and greater corrosion resistance

SAFETY PINS

For master and inner pack quantities see page 349

- Quickly secures coupler latches, pintle hooks, jack legs or caster wheels
- Square retainer wire clip provides added clearance
- Durable zinc-plated finish



Bulk #	Pkg #	Pin Diameter	Pin Length	Chain Length
25080	25081	1/4"	2-3/4"	--
25012	25013	1/4"	2-3/4"	12" chain
25010	25011	5/16"	3"	--
25034	25035	5/16"	3"	12" chain
28278	28279	3/8"	2-3/4"	--
28000	28001	3/8"	3"	12" chain



25034 securing a coupler latch



28278 securing a jack foot



SecureLatch™ lunette eye



QuickPin™ coupler

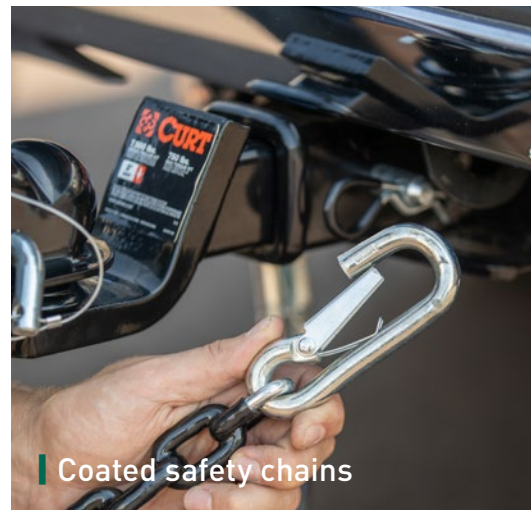

Coated safety chains



Straight-tongue coupler



SECURELATCH™ FLUSH-MOUNT LUNETTE RING

For pintles and mounts
go to page 126

- Vertically offset base allows ring to be flipped for maximum height adjustment
- Drop-in pin accepts lock to deter theft (turns 90 degrees while coupled)
- Cast iron construction is austempered for superior strength and wear resistance
- Textured, dark grey teridium finish for a premium look on your vehicle
- Yellow zinc-plated pin for long-lasting corrosion resistance
- Hardware sold separately



Drop-in pin accepts lock to deter theft (turns 90° while coupled)

Part #	GTW	Rings Hole Size	Ring Thickness	Bolt Hole Spacing	Base Size
48661	60,000 lbs.	2-1/2" I.D.	1-1/2"	4-1/2" center to center	6-1/4" square



SECURELATCH™ CHANNELS & LUNETTE RINGS

Scan to
learn more



- Drop-in pin accepts lock to deter theft (turns 90 degrees while coupled)
- Strong 2-hole bolt pattern fits 3" channel only (#48625)
- Heavy-duty 3-hole bolt pattern fits 2-3/4" channel only (#48626)
- Cast iron construction for superior strength and wear resistance (lunette rings only)
- Hardware included with #48641 kit only
- Textured, dark grey teridium finish for a premium look on your vehicle (lunette rings only)
- Raw finish for immediate welding (channels only)
- Yellow zinc-plated pin for long-lasting corrosion resistance
- U.S. patent# 5,527,356; Canadian patent# 2,823,001; Australian patent# 2014305601



Bulk #	Pkg #	GTW	Number of Positions	Ring Hole Size	Ring Thickness	Vertical Hole Spacing	Channel Width	Channel Height	Description
--	48625	25,000 lbs.	--	3" I.D.	1-1/2"	2" on center	3" I.D.	--	Lunette ring only
--	48626	40,000 lbs.	--	3" I.D.	1-1/2"	2" on center	2-3/4" I.D.	--	Lunette ring only
--	48641	40,000 lbs.	4-position	3" I.D.	1-1/2"	2" on center	2-3/4" I.D.	11-3/4"	Lunette ring and channel
48651	--	--	4-position	--	--	2" on center	2-3/4" I.D.	11-3/4"	Channel fits 48626 only
48610	--	--	3-position	--	--	2" on center	3" I.D.	7-1/2"	Channel only
48650	--	--	5-position	--	--	2" on center	3" I.D.	11-3/4"	Channel only

FORGED LUNETTE RINGS

- Single stud eliminates need for a swivel-type pintle hook (#48520, #48530)
- Threaded shank and castle nut for secure attachment to trailer (#48520, #48530)
- Flat design allows drawbar to bolt quickly and easily to a trailer tongue (#48510)
- Constructed from forged steel alloy for superior strength
- Hardware sold separately (#48510, #48550, #48560)

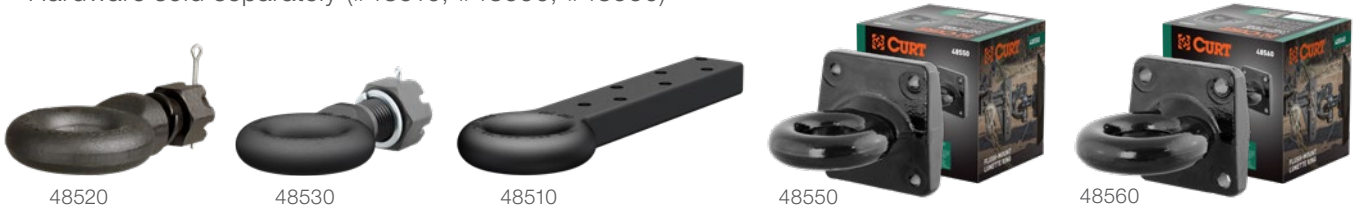

Bulk #	Pkg #	GTW	Mount-Style	Eye Hole Size	Ring Thickness	Finish
48520	--	15,000 lbs.	39mm stud with castle nut	2-1/2" I.D.	1-1/2"	Black
48530	--	45,000 lbs.	48mm stud with castle nut	3" I.D.	1-5/8"	Black
48510	--	22,000 lbs.	3" x 13" x 1-5/8" drawbar with seven-bolt holes	3" I.D.	1-5/8"	Black
--	48550	35,000 lbs.	6" x 6" flush plate with 4-1/2" center to center holes	2-1/2" I.D.	1-1/2"	Black
--	48560	60,000 lbs.	6" x 6" flush plate with 4-1/2" center to center holes	3" I.D.	1-1/2"	Black

CHANNELS & FORGED LUNETTE RINGS

- Height adjustment allows for precise trailer leveling
- Constructed from forged steel for superior strength (rings only)
- Constructed from one-piece, formed steel (channels only)



Bulk #	Pkg #	GTW	Number of Positions	Eye Hole Size	Bolt Hole Spacing	Channel Width	Channel Height	Description	Finish
48600	--	12,000 lbs.	--	3" I.D.	2" on center	--	--	Forged ring	Raw
48601	--	12,000 lbs.	--	3" I.D.	2" on center	--	--	Forged ring	Gloss black
48660	--	24,000 lbs.	--	3" I.D.	2" on center	--	--	Forged ring	Raw
48631	48630	12,000 lbs.	3-position	3" I.D.	2" on center	3" I.D.	7-1/2"	Forged ring with formed channel	Raw
48610	--	--	3-position	--	2" on center	3" I.D.	7-1/2"	Formed channel	Raw
48650	--	--	5-position	--	2" on center	3" I.D.	11-3/4"	Formed channel	Raw
48640	--	12,000 lbs.	5-position	3" I.D.	2" on center	3" I.D.	11-3/4"	Forged ring with formed channel	Raw

HELUX™ SERIES COIL SPRING PIN BOXES

NEW

- Reduces aggressive bouncing and shifting to increase the lifespan of the RV
- Prevents excessive rattling and vibrations from road hazards and degrading of RV hardware
- Easy-to-use coil spring technology and shock absorbers are maintenance free once installed
- Premium coil technology is more dependable and requires less maintenance than air systems
- Compatible with Rhino™ Box
- Tested for safety in accordance with SAE J2638



Significantly reduces jerking and jarring over traditional fixed pin boxes



Coil spring and shock technology extend life over torsion or air bags



Certified and approved on Lippert RV frames - will not void warranty

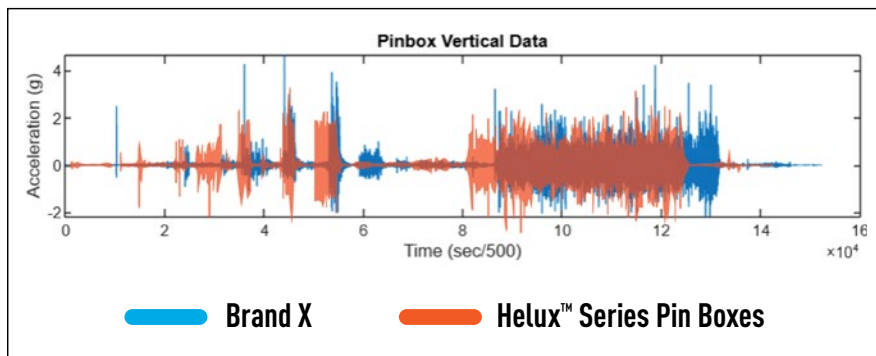

Part #	Capacity	Pin Weight	Minimum Pin Weight	GVWR Range
2024044570 N	24,000 lbs.	4,850 lbs.	2,570 lbs.	16701 - 19400
2024044571 N	24,000 lbs.	5,400 lbs.	2,860 lbs.	19401 - 21600
2024044572 N	24,000 lbs.	6,200 lbs.	3,290 lbs.	21601 - 24000



2

INCH

A-FRAME JACKS

- Top- and side-wind handles easily raise or lower trailer coupler

• See page 302 for replacement parts



Designed to be mounted on an A-frame trailer tongue



Can be bolted or welded on (hardware not included)



28204 side-wind



28255 top-wind



28203 top-wind

Bulk #	Pkg #	Lift Capacity	Wind	Travel	Bracket Ht.	Handle Type	Retracted Ht.	Extended Ht.	Finish
28200	--	2,000 lbs.	Top	14-1/4"	8"	Straight	8-1/4"	22-1/2"	Gloss black
28202	28203	2,000 lbs.	Top	14-3/4"	9"	Straight	9-1/4"	24"	Gloss black
28204	--	2,000 lbs.	Side	15"	9"	Straight	9-1/4"	24-1/4"	Gloss black
28250	--	5,000 lbs.	Top	14-1/8"	10-1/2"	Straight	10-3/8"	24-1/2"	Gloss black
25007	--	5,000 lbs.	Top	15"	10-1/2"	Claw	10"	25"	Gloss black

2

INCH

SWIVEL JACKS

- Top- and side-wind handles easily raise or lower trailer coupler
- Swivel bracket allows jack to fully swing up and out of the way

• See page 302 for replacement parts



Bracket-mount pull-pin keeps jack securely locked in place



Raw socket included for welding onto the trailer



28302 bracket-mount



28354 pipe-mount

Bulk #	Pkg #	Lift Capacity	Wind	Travel	Hole Size	Handle Type	Style	Retracted Ht.	Extended Ht.
28320	--	2,000 lbs.	Top	10-3/4"	9/16"	Claw	Pipe-mount	11"	21-3/4"
25006	--	5,000 lbs.	Top	10"	9/16"	Claw	Pipe-mount	11-1/4"	21-1/4"
28356	--	5,000 lbs.	Top	15"	5/8"	Claw	Pipe-mount	16-1/2"	31-1/2"
28322	28323	2,000 lbs.	Top	15"	9/16"	Claw	Pipe-mount	16"	31"
28321	--	2,000 lbs.	Side	10"	9/16"	Straight	Pipe-mount	17-1/2"	28-1/2"
28354	--	5,000 lbs.	Side	10"	5/8"	Straight	Pipe-mount	10-1/4"	20-1/4"
25005	--	3,000 lbs.	Side	15"	5/8"	Straight	Pipe-mount	15-1/2"	30-1/2"
28324	--	2,000 lbs.	Side	15"	9/16"	Straight	Pipe-mount	15-1/4"	30-1/8"
28300	28301	2,000 lbs.	Top	10-1/2"	--	Claw	Bracket-mount	11-1/2"	21-1/2"
28302	--	2,000 lbs.	Side	10"	--	Straight	Bracket-mount	10"	20-1/2"
28304	--	2,000 lbs.	Top	15-1/4"	--	Claw	Bracket-mount	16"	31-1/4"
28306	--	2,000 lbs.	Side	14-1/2"	--	Straight	Bracket-mount	15-1/2"	30"

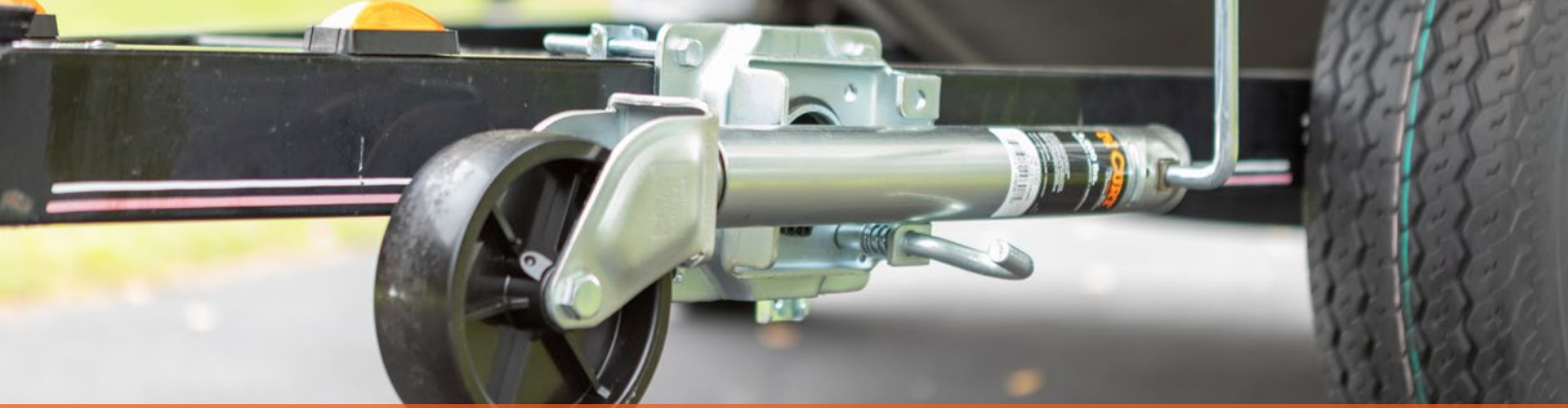

BUILT-IN WHEEL FOR CONVENIENT MOBILITY

2 INCH MARINE JACKS

- Caster wheel for trailer mobility and easier coupling
- Bolt-on hardware included for secure mounting
- See page 302 for replacement parts



Swivel bracket allows jack to fully swing up during travel



Heavy-duty pull-pin locks jack securely in place



25004

28115

28156

Bulk #	Pkg #	Lift Capacity	Wind	Travel	Bracket Ht.	Wheel Size	Retracted Ht.	Extended Ht.	Finish
25004	25003	1,000 lbs.	Side	10"	12-1/4"	6"	9-1/4"	19-1/4"	Zinc-plated
28112	28113	1,200 lbs.	Side	11"	12-11/16"	6"	12-1/2"	23-1/2"	Zinc-plated
28115	28116	1,500 lbs.	Side	11"	12-11/16"	8"	13"	24"	Zinc-plated
28155	28156	1,500 lbs.	Side	10-3/8"	12-1/2"	Dual 6"	12-5/8"	23"	Zinc-plated

DIRECT-WELD SQUARE JACKS

- Designed to weld directly to the trailer frame
- Drop leg with spring return for fast retraction (#28512)
- Pull-pin keeps jack leg securely locked in place
- See page 302 for replacement parts



28512

28570

28575

28359

Part #	Lift Capacity	Support	Wind	Travel	Handle Type	Inner Tube	Retracted Ht.	Extended Ht.	Incl. Jack Foot
28512	10,000 lbs.	12,000 lbs.	Side	12-3/8"	Straight	3-1/2"	28"	40-1/4"	Yes
28570	7,000 lbs.	8,000 lbs.	Top	15-1/4"	Claw	2-1/4"	24-1/4"	39-1/2"	Yes
28575	7,000 lbs.	8,000 lbs.	Side	15"	Straight	2-1/4"	24-3/4"	40-1/8"	Yes
28359	3,000 lbs.	5,000 lbs.	Side	15-1/4"	Straight	2"	24-5/8"	39-7/8"	No

2

INCH

JACK ACCESSORIES

- Caster assemblies #28276 and #28277 are not designed as repair parts for marine jacks; use jack repair part number #28912



28270 28271



28273 28272



28275 28274



28277 28276



28278 28279

Bulk #	Pkg #	Description	Capacity	Fits Tube	Height	Wheel Size	Diameter
28270	28271	Pivoting jack foot, bolt-on	2,000 lbs.	2"	--	--	--
28272	28273	Jack foot	2,000 lbs.	2"	1-11/16"	--	--
28274	28275	Jack foot	2,000 lbs.	2"	8-1/2"	--	--
28276	28277	Caster assembly with poly wheel	1,200 lbs.	2"	--	6" x 2"	--
28278	28279	Safety pin	--	--	--	--	3/8"

QUICK DROP® DRILL-OPERATED A-FRAME JACK BY LIPPERT

- Fits most cargo, utility and travel trailers
- Includes manual hand crank for backup operation
- Do not use impact drill for operation
- Durable gloss black powder coat finish
- Removable jack foot
- Patent #10,463,161



Innovative 3/4" top nut allows jack to be raised or lowered with a power drill



Faster, easier operation with no hand cranking required



733926

Part #	Lift Capacity	Wind	Handle Type	Travel	Bracket Height	Retracted Height	Extended Height	Finish
733926	2,000 lbs.	Top	Straight	14"	8-1/2"	9-1/2"	23-1/2"	Gloss black



POWER YOUR JACK DIRECTLY FROM YOUR VEHICLE

POWER STANCE™ ELECTRIC A-FRAME JACK BY LIPPERT

- Raises and lowers trailer tongue using vehicle or trailer battery power
- Can be hardwired into trailer or plugged into any vehicle 7-way RV blade
- Four LEDs illuminate the area for easier nighttime setup
- Helical-cut gears reduce noise and improve operating efficiencies
- Enhanced rocker switch for improved durability and ease of operation
- Removable jack foot for increased trailer stability
- Includes emergency hand crank for manual backup
- Patent-pending

813749



813748



Power Swap cord connects to the vehicle, instead of draining the RV battery or hand cranking



Integrated chain hangers and 7-way inlet underneath the jack hood for convenient storage



Built-in LED lights shine down on the coupler making it easy to see and operate your jack at night



Equipped with an emergency manual crank option, so you will never be stranded

Part #	Lift Capacity	Travel	Bracket Height	Retracted Height	Extended Height	Main Body Material	Finish
813748	3,500 lbs.	18"	9"	10-5/8"	28-5/8"	UV-resistant black plastic	Gloss black
813749	Power Swap Auxiliary Cord for Power Stance tongue jack						

HAND-CRANK SINGLE-SPEED WINCHES

- Constructed from high-strength, cold-forged steel
- Equipped with a locking lever for increased safety
- Broached pinion shaft securely engages the pinion gear
- Straps made from 2" wide, no-stretch nylon web
- Base features slotted screw holes for flexible mounting



Crank-style winches for boat trailers or hoisting applications

#25002 includes bow loop strap for jet ski trailers (#25002)



29423



29433



29424



29435



29427



25002

Part #	Capacity	Gear Ratio	Hub Diameter	Drum Width	Handle Length	Strap Included	Bow Loop Included
25002	900 lbs.	3.25:1	3/4"	2"	8"	Yes, 20'	Yes
29423	900 lbs.	3.25:1	3/4"	2"	6-1/2"	No	No
29433	900 lbs.	3.25:1	3/4"	2"	6-1/2"	Yes, 15' (29450)	No
29424	1,200 lbs.	4.2:1	3/4"	2"	7-1/2"	No	No
29435	1,400 lbs.	4.2:1	3/4"	2"	7-1/2"	Yes, 20' (29451)	No
29427*	1,700 lbs.	5.1:1	1"	2"	8"	No	No

* Continued while supplies last

WINCH STRAPS

- Made from 2" wide, no-stretch nylon web
- Zinc-plated snap hook for easy, secure hookup



29007

NEW



29452

29450 & 29451

Bulk #	Pkg #	Work Load	Break Strength	Strap Width	Strap Length
29007	--	1,333 lbs.	4,000 lbs.	2"	20'
--	29450	1,100 lbs.	3,300 lbs.	2"	15'
--	29451	1,100 lbs.	3,300 lbs.	2"	20'
--	29452 N	1,600 lbs.	4,800 lbs.	2-3/8"	23'

HAND-CRANK 2-SPEED WINCHES

NEW

- Compatible replacement for most Dutton-Lainson* and Fulton* winches
(*Brands are registered trademarks of Dutton-Lainson Company and First Brands Group)
- Ideal for winching +20-foot-long boats onto boat trailer
- Locking lever for increased safety
- Universal, slotted screw holes for flexible mounting
- 2-speed design for pulling in large boats with ease
- Two input shafts and quick-detach handle for varying leverage (#29532, #29538 only)
- Broached pinion shaft to securely engage the pinion gear
- Comfort grip handle for ergonomic cranking
- Straps and cables not included
- Five-year limited warranty
- **See page 302 for replacement parts**



29520



29526



29532



29538



Crafted from high-quality, cold-forged steel with solid gears, this 2-speed winch delivers reliable performance every time.



600-hour salt-spray tested zinc plating provides top corrosion resistance in harsh environments.



Universal, slotted screw holes offer flexible mounting options for hassle-free installation

Part #	Capacity	Hub Diameter	Drum Width	Low Gear Ratio	High Gear Ratio	Handle Length
29520 N	2,000 lbs.	1"	2-1/2"	10.25:1	4.1:1	10-5/8"
29526 N	2,600 lbs.	1"	2-1/2"	12.7:1	5.1:1	10-5/8"
29532 N	3,200 lbs.	1-1/8"	2-1/2"	17.5:1	5.4:1	9-5/8"
29538 N	3,800 lbs.	1-3/4"	3-3/4"	15.8:1	5.1:1	9-5/8"

HAND-CRANK BRAKE WINCHES

NEW

- Compatible replacement for most Dutton-Lainson® and Fulton® winches
*Brands are registered trademarks of Dutton-Lainson Company and First Brands Group)
- Self-activating, automatic brake holds loads securely
- Solid gears provide superior strength vs. laminated gears
- Oil-impregnated metal bushings for smooth operation
- Broached pinion shaft to securely engage the pinion gear
- Comfort grip handle for ergonomic cranking
- Gear cover for added protection against injuries
- Slotted screw holes offer flexible mounting options for hassle-free installation
- Straps and cables not included
- Five-year limited warranty
- **See page 302 for replacement parts**



29610



29615



29625



Two input shafts and quick-detach handle for varying leverage (#29610 only)



600-hour salt-spray tested zinc plating provides top corrosion resistance in harsh environments



Prioritizing user safety, this winch is equipped with a locking lever for increased safety and a comfort grip handle for ergonomic cranking

Part #	Capacity	Hub Diameter	Drum Width	Gear Ratio	Handle Length
29610 N	1,000 lbs.	2-1/4"	2.0"	4.2:1	7"
29615 N	1,500 lbs.	2-1/2"	2.2"	5:1	10-5/8"
29625 N	2,500 lbs.	3-1/4"	3.8"	15.8:1	10-5/8"

WINCH CABLES WITH SNAP HOOK

- Zinc-plated snap hook for easy, secure hookup

Part #	Length	Diameter	Break Strength	Winch Capacity
29460 N	25'	3/16"	4,200 lbs.	1,800 lbs.
29461 N	50'	7/32"	5,600 lbs.	2,500 lbs.



CARGO STRAPS

- Cambuckle mechanism allows for quick, direct tension on lighter loads
- Ratchet mechanism allows for greater tension on heavy loads
- High-strength, woven nylon
- Cinching components protected by a durable yellow zinc-plated finish



Perfect for securing cargo in trailers, truck beds, and more



Secures cargo better than bungee cords or rope



83036



83047



83048



83015



83016



83001



83002



83009



83010



83019



83020



83025



83026



83027



83028

Part #	Work Load	Break Strength	Quantity	Color	Length	Width	Hook Style	Hook Finish	Mechanism
83015	300 lbs.	900 lbs.	2	Dark green	15'	1"	S-hook	Rubber-coated	Cambuckle
83016	300 lbs.	900 lbs.	4	Dark green	16'	1"	S-hook	Rubber-coated	Cambuckle
83001	500 lbs.	1,500 lbs.	2	Red	10'	1"	S-hook	Rubber-coated	Ratchet
83002	500 lbs.	1,500 lbs.	4	Red	16'	1"	S-hook	Rubber-coated	Ratchet
83009*	500 lbs.	1,500 lbs.	2	Black	10'	1"	S-hook	Rubber-coated	Ratchet
83010*	500 lbs.	1,500 lbs.	4	Black	16'	1"	S-hook	Rubber-coated	Ratchet
83019	733 lbs.	2,200 lbs.	1	Blue	16'	1"	J-hook	Rubber-coated	Ratchet
83020	733 lbs.	2,200 lbs.	2	Blue	16'	1"	J-hook	Rubber-coated	Ratchet
83027	1,100 lbs.	3,300 lbs.	1	Lime green	16'	1"	S-hook	Rubber-coated	Ratchet
83028	1,100 lbs.	3,300 lbs.	2	Lime green	16'	1"	S-hook	Rubber-coated	Ratchet
83036	1,667 lbs.	5,000 lbs.	1	Yellow	14'	1-1/2"	J-hook	Yellow zinc-plated	Ratchet
83047	3,333 lbs.	10,000 lbs.	1	Yellow	27'	2"	J-hook	Yellow zinc-plated	Ratchet
83048	3,333 lbs.	10,000 lbs.	1	Yellow	27'	2"	Flat hook	Yellow zinc-plated	Ratchet

* Continued while supplies last



MAKE SAFETY A PRIORITY WHEN YOU TOW

PROPER SAFETY CHAIN USAGE

Safety chains are required by law and should be crossed under the tongue of the trailer so that the tongue will not drop to the road if it becomes separated from the hitch. Always leave enough slack so the vehicle can safely turn. Never allow the safety chains to drag on the ground and never attach the chains to the bumper.

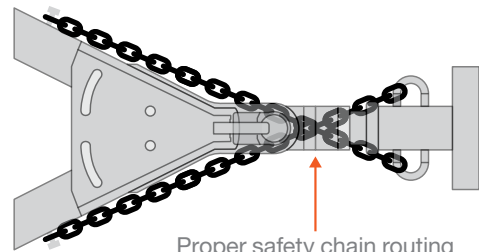

Proper safety chain routing crosses under the coupler

SAFETY CHAINS WITH S-HOOKS



S-hook



Helps prevent total vehicle-trailer separation during a disconnect

Bulk #	Pkg #	Break Strength	Number of Chains	Total Length	Chain Length	Link Diameter	Hooks Per Chain	Hook Opening	Grade	Finish
80020	--	2,000 lbs.	1	27"	23"	3/16"	1 (81260)	3/8"	30	Zinc-plated
80010	80011	2,000 lbs.	1	48"	40"	3/16"	2 (81260)	3/8"	30	Zinc-plated
80040	--	5,000 lbs.	1	27"	23"	1/4"	1 (81270)	7/16"	30	Zinc-plated
80030	80031	5,000 lbs.	1	48"	40"	1/4"	2 (81270)	7/16"	30	Zinc-plated
80300	--	7,000 lbs.	1	27"	23"	8/0	1 (81620)	17/32"	30	Zinc-plated
80301	--	7,000 lbs.	1	48"	40"	8/0	2 (81620)	17/32"	30	Zinc-plated



Federal law requires safety chains or cables to be secured while towing. Each individual chain or cable must meet or exceed the trailer weight.

SAFETY CHAINS WITH SNAP HOOKS

- Spring-loaded safety latch helps ensure secure attachment
- Protected by a durable zinc-plated finish
- Vinyl coating protects chains from rust and allows for easier handling (#19749)



19749



80312



80313



Snap hook



Helps resist total vehicle-trailer separation during a disconnect

Bulk #	Pkg #	Break Strength	Number of Chains	Total Length	Chain Length	Link Diameter	Hooks Per Chain	Hook Opening	Grade	Finish
80312	--	2,000 lbs.	1	27"	24"	3/16"	1 (81266)	3/8"	30	Zinc-plated
80313	--	5,000 lbs.	1	27"	24"	1/4"	1 (81277)	7/16"	30	Zinc-plated
--	19749	5,000 lbs.	2	65"	60"	1/4"	2 (81260)	7/16"	30	Zinc-plated with rubber coating

TRAILER SAFETY CHAIN HOLDER BRACKETS

- Provides intermediate hangers to keep safety chains off the ground (not intended as a safety chain secure point)
- Requires clearance on the shank between receiver collar and accessory (see table)
- Hooks maintain proper safety chain function for trailer disconnect



45807



45806

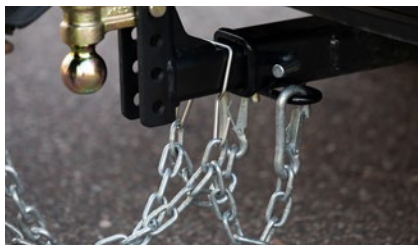

Provides intermediate hangers to keep chains off the ground

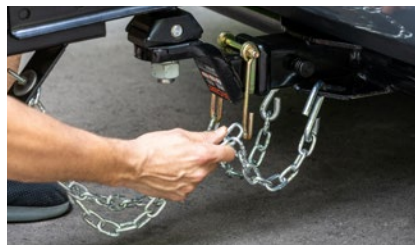

Hooks maintain proper safety chain function for trailer disconnect

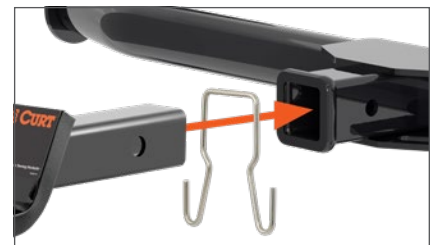

Easily clips onto most 2" shanks (#45807)

Part #	Fits	Style	Required Clearance	Includes	Finish
45806	2" shanks	Bolt-on	5/8"	Bracket and hardware	Yellow zinc-plated
45807	2" shanks	Clip-on	1/4"	Bracket only	Stainless steel



Federal law requires safety chains or cables to be secured while towing. Each individual chain or cable must meet or exceed the trailer weight.

SAFETY CABLES WITH SAFETY LATCH HOOKS

- Coiled design keeps cables from dragging on the ground
- Nylon coating protects cables from rust and allows for easier handling
- Assembled with two safety latch hooks for secure attachment



Safety latch S-hook



Helps prevent total vehicle-trailer separation during a disconnect



80136



80151



80176

Part #	Break Strength	Number of Cables	Total Length	Cable Length	Cable Diameter	Hooks Per Cable	Hook Opening	Cable Finish	Hook Finish
80136	3,500 lbs.	2	43-7/8"	40-1/2"	1/4"	2 (81810)	3/8"	Nylon-coated	Zinc-plated
80151	5,000 lbs.	2	44-1/2"	40-1/2"	5/16"	2 (81820)	7/16"	Nylon-coated	Zinc-plated
80176	7,500 lbs.	2	44"	39-3/4"	3/8"	2 (81830)	17/32"	Nylon-coated	Zinc-plated

SAFETY CHAINS WITH SAFETY LATCH CLEVIS HOOKS

- Exclusive clevis design and spring-loaded safety latch help ensure secure attachment
- Hooks constructed from high-strength, heat-treated, forged steel
- Protected by a durable zinc-plated finish



Zinc-plated



Yellow zinc-plated

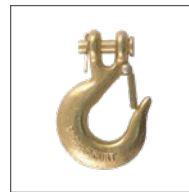

Safety latch clevis hooks



Helps prevent total vehicle-trailer separation during a disconnect

Part #	Break Strength	Number of Chains	Total Length	Chain Length	Link Diameter	Hooks Per Chain	Hook Opening	Grade	Chain Finish	Hook Finish
80302	7,800 lbs.	1	35"	32"	1/4"	1 (81900)	1/4"	43	Zinc-plated	Yellow zinc-plated
80314	11,700 lbs.	1	35"	32"	5/16"	1 (81550)	5/16"	43	Zinc-plated	Yellow zinc-plated
80303	12,600 lbs.	1	35"	32"	1/4"	1 (81940)	1/4"	70	Yellow zinc-plated	Yellow zinc-plated
80315	16,200 lbs.	1	35"	31"	3/8"	1 (81560)	3/8"	43	Zinc-plated	Yellow zinc-plated
80304	18,800 lbs.	1	35"	32"	5/16"	1 (81950)	5/16"	70	Yellow zinc-plated	Yellow zinc-plated
80316	24,000 lbs.	1	35"	31"	3/8"	1 (81960)	3/8"	70	Yellow zinc-plated	Yellow zinc-plated



TIE-DOWN AND BIND YOUR HEAVY-DUTY CARGO

TRANSPORT BINDER SAFETY CHAINS

- Grade-70 rating for superior tensile strength and abrasion resistance
- Assembled with two clevis grab hooks for secure attachment
- Durable yellow zinc-plated finish
- Do not exceed work load limit



80306



80307

Part #	Work Load	Break Strength	Total Length	Chain Length	Link Diameter	Hooks Per Chain	Hook Opening	Grade	Finish
80305	4,700 lbs.	18,800 lbs.	14'	162"	5/16"	2 (81503)	5/16"	70	Yellow zinc
80306	4,700 lbs.	18,800 lbs.	16'	186"	5/16"	2 (81503)	5/16"	70	Yellow zinc
80307	4,700 lbs.	18,800 lbs.	20'	234"	5/16"	2 (81503)	5/16"	70	Yellow zinc
80308	4,700 lbs.	18,800 lbs.	25'	294"	5/16"	2 (81503)	5/16"	70	Yellow zinc
80309	6,600 lbs.	26,400 lbs.	14'	162"	3/8"	2 (81438)	3/8"	70	Yellow zinc
80310	6,600 lbs.	26,400 lbs.	16'	186"	3/8"	2 (81438)	3/8"	70	Yellow zinc
80311	6,600 lbs.	26,400 lbs.	20'	234"	3/8"	2 (81438)	3/8"	70	Yellow zinc

CLEVIS GRAB HOOKS

- Meets requirements for high-test chain
- Can also be used to connect safety chains from trailer to tow vehicle
- Constructed from high-strength, forged steel



81330



81502



81340



81503



81350



81438

Part #	GTW	Hook Opening	Grade	Pin Diameter	Finish
81330	2,600 lbs.	1/4"	43	3/8"	Zinc-plated
81502	3,150 lbs.	1/4"	70	3/8"	Yellow zinc-plated
81340	3,900 lbs.	5/16"	43	7/16"	Zinc-plated
81503	4,700 lbs.	5/16"	70	7/16"	Yellow zinc-plated
81350	5,400 lbs.	3/8"	43	1/2"	Zinc-plated
81438	6,600 lbs.	3/8"	70	1/2"	Yellow zinc-plated

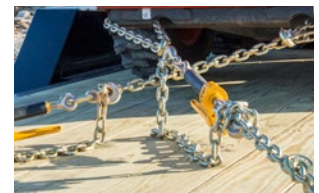

Used on transport binder safety chain to tie down heavy cargo



Federal law requires safety chains or cables to be secured while towing. Each individual chain or cable must meet or exceed the trailer weight.

SAFETY LATCH CLEVIS HOOKS

- Quickly and easily connects safety chains from trailer to tow vehicle
- Exclusive design and spring-loaded safety latch help ensure secure attachment
- Meets requirements for high-test (grade 40), transport (grade 70) or alloy chain (grade 80)
- Hook pin and cotter pin provide an easy, secure attachment to safety chain
- Built from high-strength, heat-treated, forged steel
- Protected by a durable yellow zinc-plated finish

Part #	GTW	Hook Opening	Grade	Pin Diameter
81900	7,800 lbs.	1/2"	43	5/16"
81940	12,600 lbs.	1/2"	70	5/16"
81550	14,000 lbs.	3/4"	43	3/8"
81950	18,000 lbs.	3/4"	70	3/8"
81560	18,000 lbs.	1"	43	7/16"
81960	24,000 lbs.	1"	70	7/16"
81970	40,000 lbs.	1-1/3"	80	17/32"
81910	35,000 lbs.	1-1/4"	43	5/8"
81980	48,000 lbs.	1-1/4"	80	5/8"
81920	65,000 lbs.	1-1/4"	80	3/4"



81900



81940



81550



81950



81560



81960



81970



81910



81980



81920

CERTIFIED S-HOOKS

- Quickly and easily connects safety chains or cables from trailer to tow vehicle
- Tested for safety in accordance with SAE J684
- Wire safety latch helps ensure secure attachment
- Strong, heat-treated steel with a zinc-plated finish

Part #	GTW	Hook Opening	Safety Latch
81260	2,000 lbs.	3/8"	No
81810	2,000 lbs.	3/8"	Yes
81640	3,500 lbs.	13/32"	No
81840	3,500 lbs.	13/32"	Yes
81270	5,000 lbs.	7/16"	No
81820	5,000 lbs.	7/16"	Yes
81620	7,600 lbs.	17/32"	No
81830	7,600 lbs.	17/32"	Yes



81810



81260



81840



81640



81820



81270



81830



81620

SNAP HOOKS

For master and inner pack quantities see page 349

- Quickly and easily connects safety chains from trailer to tow vehicle
- Spring-loaded safety latch helps ensure secure attachment
- Patent# 5,664,304

Bulk #	Pkg #	GTW	Diameter
81266	81261	2,000 lbs.	3/8"
81277	81271	5,000 lbs.	7/16"
81288	81281	5,000 lbs.	9/16"
81360	--	3,500 lbs.	5/8" eye



QUICK LINKS

- Provides a quick connection for chains, cables, ropes, or straps
- Threaded link ensures secure attachment with the option to disconnect later
- Requires no tools for installation
- Do not exceed work load limit



Bulk #	Pkg #	Two-Pack #	Work Load	Diameter	Finish
82610	82611	--	880 lbs.	1/4"	Zinc
82900	82901	82903	1,760 lbs.	5/16"	Zinc
82930	82933	--	2,200 lbs.	3/8"	Zinc
82931	82934*	--	2,640 lbs.	7/16"	Zinc
82932	82935	--	3,300 lbs.	1/2"	Zinc

* Continued while supplies last



JOINING LINKS

- Constructed from 1038 steel
- Do not use for lifting
- Welding required

Part #	Finish	Size
82940	Raw	9/0
82942	Raw	7/16"
82944*	Zinc-plated	7/16"

* Continued while supplies last



RINGS & TIE-DOWN ANCHORS

See adjacent page
for part number table

Recessed rope rings

- Recessed design eliminates obstruction and provides a finished look
- Constructed from high-strength steel
- Mounting screws not included



83601



83710



83600

D-rings

- Constructed from high-strength steel
- Mounting screws not included



83740



83742



83732



83730



83731 two-pack

Backing plate

- Adds strength to tie-down anchors
- Constructed from high-strength steel
- Compatible with #83600, #83740 and #83742
- Mounting screws not included

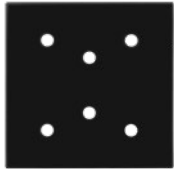

83607



83740 & 83607

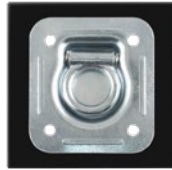

83600 & 83607

Trim ring

- Provides a clean, finished look for recessed plate #83710
- Helps protect plate edges from damage and corrosion



83720



83710 in 83720

Lashing rings

- Heavy-duty design with large opening offers a reliable anchoring point
- Raw finish allows for ready welding of mounting bracket
- Constructed from high-strength, forged steel



83750



83760



83770



83780

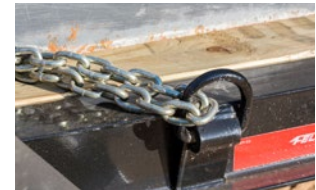

Adds attachment point to a trailer

RINGS & TIE-DOWN ANCHORS

Part #	Capacity	Break Strength	Finish	Base Size	Mount Hole Size	Mounting Hole Pattern	Ring I.D.	Ring Thickness
Recessed Rope Rings								
83710	1,000 lbs.	1,000 lbs	Zinc-plated	3-1/2" x 3-1/2"	1/4"	1-3/16"	1-1/8" x 1-5/8"	1/4"
83601	1,200 lbs.	1,200 lbs.	Zinc-plated	5" x 3-1/2"	1/4"	4-1/16" x 1/4"	1-3/8" x 1-7/8"	1/4"
83600	5,000 lbs.	7,000 lbs.	Zinc-plated	4-7/8" x 4-1/2"	3/8"	3-3/8" x 2-7/8"	1-1/2" x 1-1/2"	1/2"
D-Rings								
83730	1,200 lbs.	2,400 lbs.	Zinc-plated	2-1/4" x 13/16"	1/4"	1-1/2"	1" x 1-1/4"	1/4"
83731*	1,200 lbs.	2,400 lbs.	Zinc-plated	2-1/4" x 13/16"	1/4"	1-1/2"	1" x 1-1/4"	1/4"
83732	1,200 lbs.	2,400 lbs.	Stainless	2-1/4" x 13/16"	1/4"	1-1/2"	1" x 1-1/4"	1/4"
83740	3,600 lbs.	11,000 lbs.	Yellow zinc-plated	1-3/4" x 3-11/16" x 7/8"	7/16" square	2"	3" x 3"	1/2"
83742	3,600 lbs.	11,000 lbs.	Zinc-plated	1-3/4" x 3-11/16" x 7/8"	7/16" square	2"	3" x 3"	1/2"
Backing Plate and Trim Ring								
83720	--	--	Plastic	--	--	--	3" x 3"	3/8"
83607	--	--	Gloss black	6" x 6"	7/16"	3" x 3-1/4" (2" center)	--	--
Lashing Rings								
83750	6,100 lbs.	18,000 lbs.	Raw steel	2-1/4" x 1-5/8" x 1-1/4"	--	--	3" x 3"	5/8"
83760	8,833 lbs.	26,500 lbs.	Raw steel	2-1/4" x 1-5/8" x 1-1/4"	--	--	3" x 3"	3/4"
83770	15,587 lbs.	46,760 lbs.	Raw steel	2-1/4" x 2-1/8" x 1-3/4"	--	--	3" x 3"	1"
83780	15,587 lbs.	47,000 lbs.	Raw steel	2-1/4" x 2-1/8" x 1-3/4"	--	--	3" x 4"	1"

* Packaged two-pack

FOLD-AWAY ROPE HOOK

- Fold-away design eliminates obstruction and provides a finished look
- Includes mounting hardware



Folds out as needed and folds away to be unobtrusive



83060

83061

WELD-ON STAKE POCKET

- Perfectly sized to accept a 2x4 wood or metal stud
- Raw finish allows for ready welding
- Made in the USA



83072

Bulk #	Pkg #	Capacity	Finish
83060	83061	1,200 lbs.	Chrome-plated

Part #	Finish	Height	Thickness	Inside Width	Inside Depth
83072	Raw	3"	3/16"	3-1/2"	1-5/8"



QUICKLY STOW AWAY AND SAVE INTERIOR SPACE

TRAILER-MOUNTED HD RUBBER WHEEL CHOCKS

- Convenient storage prevents dirt inside your truck or RV and saves space
- Snap-ring clips with wire lanyard store chocks and prevent lost pieces
- Ridged bottom surface prevents chock slippage and movement
- Heavy-duty rubber and steel construction provides long-lasting durability
- Self-tapping screws and trailer frame mounting brackets included

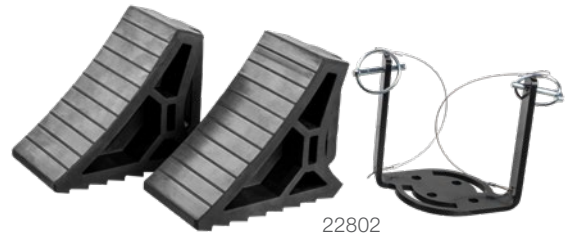

Quickly mount wheel chocks to the trailer frame for easy storage and quick access



Large handles in wheel chocks provide easy carrying and use

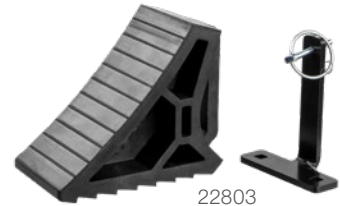

Part #	Includes
22801	One wheel chock
22803	One wheel chock, single-mount bracket and mounting hardware
22802	Two wheel chocks, dual-mount bracket and mounting hardware

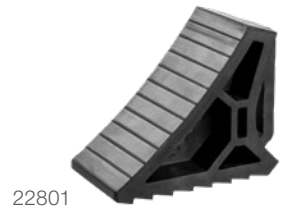

WHEEL CHOCK SET

- Raised tread offers a better grip on the wheel
- Saw-tooth edges on the base provide solid traction on the ground
- Always to be used with emergency brake
- Nestable design for compact storage
- Not for commercial use



22800



Adds safety during vehicle maintenance or to parked trailers

Part #	Description
22800	For use with wheels up to 17" wide

WHEEL BEARING KITS

- Automatically maintains the correct internal pressure to avoid seal damage
- Includes two bearing cones, two bearing cups, a grease seal and cotter pin

Part #	Spindle O.D.	Kit Includes
23209	3/4"	(2) LM11910, (2) LM11949, seal, cotter pin
23210	1"	(2) L44643, (2) L44610, seal, cotter pin
23211	1-1/16"	(2) L44649, (2) L44610, seal, cotter pin



23210

23211

BEARING PROTECTORS AND DUST COVERS

- Protects wheel bearings from dirt, water, and road grime
- Maintains pressure and keeps bearing greased
- Features a small reservoir to keep bearings well-lubricated
- Covers prevent dust and debris from entering the bearing protector
- Includes two components each



22178

22244

23198

Part #	Dust Cover Two-Pack #	Hub Bore Size
22178	23178	1.78" diameter
22198	23198	1.98" diameter
22232	23232	2.32" diameter
22244	23244	2.44" diameter

REPLACEMENT PARTS

CLEVIS HOOK LATCH

Part #	Description	Fits
81999	Clevis hook latch	81950



CHANNELS & LUNETTE RINGS

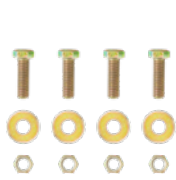

48553



48332

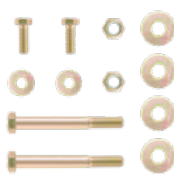

48620

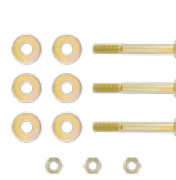

48552

Bulk #	Pkg #	Description	Fits
Lunette Rings			
48553	--	Hardware kit includes: - 3/4" hex bolts, qty 4 - 3/4" nylock nuts, qty 4 - 3/4" flat washers, qty 4	48560 48661
48332	--	Hardware kit includes: - 5/8" socket head cap screw, qty 4 - 5/8" hex nuts, qty 4 - 5/8" lock washers, qty 4	48550

Bulk #	Pkg #	Description	Fits
Channels			
48620	48621	Hardware kit includes: - 5/8" x 5-1/2" hex bolts, qty 2 - 5/8" nylock nuts, qty 2 - 5/8" flat washers, qty 4 - 1/2" x 1-1/2" hex bolts, qty 2 - 1/2" flat washers, qty 2	48630 48631 48610 48650 48640
48552	--	Hardware kit includes: - 5/8" hex bolts, qty 3 - 5/8" nylock nuts, qty 3 - 5/8" flat washers, qty 6	48641 48651 48610 48650

COUPLERS



19272



25094



25194



25294



25388

Bulk #	Pkg #	Description	Fits
QuickPin Couplers			
19272	--	1/2" pin, clip and lanyard	25470 25471 25472
Straight-Tongue Couplers			
--	25094	Posi-lock latch for 1-7/8" couplers	25105 25128 25131
--	25194	Posi-lock latch for 2" couplers	25153 25135 25138 25100

Bulk #	Pkg #	Description	Fits
A-Frame Couplers			
--	25294	Posi-lock latch for 2" couplers	25101 25210
Channel-Mount Couplers			
25388	25398	Hardware kit includes: - 5/8" x 4-3/4" hex bolts, qty 2 - 5/8" nylock nuts, qty 2 - 5/8" flat washers, qty 4	25319 25329 25330 25328

JACK & WINCH REPLACEMENT PARTS

Marine Jacks

Bulk #	Pkg #	Description	Fits
28910	--	Bolt-through mounting bracket	All
28911	--	Bolt-through mounting bars (two) and bolts (four)	All
28912	24014	Caster wheel with bolt and bushing	All
25015	--	Side-wind handle with hardware	All
28914	--	Gear kit with shear pins	All
28926	--	Handle grip with cap nut	All
28939	28941	Snap ring, 2"	28100, 28101
28940	--	Mounting bracket pull-pin, 1/2"	All

A-Frame Jacks

Bulk #	Pkg #	Description	Fits
28921	--	Handle	28200, 28202, 28203, 28250
28925	--	Plastic top cap	28204
28926	--	Handle grip with cap nut	28200, 28202, 28203, 28204, 28250
28927	--	Top-wind handle knob with cap nut	28255
28937	28944	Top-wind handle with hardware	28255

Swivel Jacks

Bulk #	Pkg #	Description	Fits
28922	--	Bearing for top-wind jacks	28320, 28350, 28356, 28322, 28323, 28300, 28301, 28304
25015	--	Side-wind handle with hardware	All
28924	--	Gear kit with shear pins for side-wind jacks	28321, 28354, 28358, 28324, 28302, 28306
28930	--	Female pipe weld-on, 9/16" pin hole	28320, 28350, 28322, 28323, 28321, 28324
28931	28942	Male pipe weld-on, 9/16" pin hole	28320, 28350, 28322, 28323, 28321, 28324
28932	28943	Male pipe weld-on, 5/8" pin hole	28356, 28354, 28358
28934	--	9/16" pin with 3-1/2" long chain	28320, 28350, 28322, 28323, 28321, 28324
28935	--	5/8" pin with 3-1/2" long chain	28356, 28354, 28358
28938	--	Mounting bracket	28300, 28301, 28302, 28304, 28306
28926	--	Handle grip with cap nut	28321, 28354, 28358, 28324, 28302, 28306
28927	--	Top-wind handle knob with cap nut	28320, 28350, 28356, 28322, 28323, 28300, 28301, 28304
28937	28944	Top-wind handle (hardware incl.)	28320, 28350, 28356, 28322, 28323, 28300, 28301, 28304
28939	28941	Snap ring, 2"	28300, 28301, 28302, 28304
28940	--	Mounting bracket pull-pin, 1/2"	28300, 28302, 28304, 28306

Direct-Weld Square Jacks

Bulk #	Pkg #	Description	Fits
28950	--	Gear kit with shear pins	28512
28951	--	Handle	28512
28952	--	Cap	28512
28953	--	Handle clip	28512
28954	--	Bearing	28512
28955	--	Pull-pin assembly (3/4" pull-pin, spring, washer and cotter pin)	28512
19284	--	Threaded ACME rod and nut	28512
28957	--	Inner pipes with drop leg, foot and pull-pin	28512
28958	--	Gear kit with shear pins	28575
25015	--	Side-wind handle with hardware	All

Bulk #	Pkg #	Description	Fits
28961	--	Cap and screws	28575
28926	--	Handle grip with cap nut	28575, 28359
28962	--	Drop leg with foot	28575, 28570
28963	--	Drop leg foot pin	28575, 28570
28964	--	Handle kit	28570
28965	--	Bearing	28570
28927	--	Top-wind handle knob with cap nut	28570
28937	28944	Top-wind handle (hardware incl.)	28570

2-Speed Winches

Pkg #	Description	Fits
29470	Cable keeper	29520, 29526, 29532, 29538 29610, 29615, 29625
29480	Strap bolt	29520, 29526, 29532
29490	10" Quick release handle & nylock nut	29532, 29538
29491	10" Handle & nylock nut	29520, 29526, 29615, 29625

Brake Winches

Pkg #	Description	Fits
29470	Cable keeper	29520, 29526, 29532, 29538 29610, 29615, 29625
29491	10" Handle & nylock nut	29520, 29526, 29615, 29625
29493	7" Handle & nylock nut	29610

PREMIUM AXLE PARTS RETAIL PROGRAM

Lippert is your ultimate one-stop shop for axle parts and components. Our comprehensive offering features premium replacement parts meticulously crafted to meet the highest standards of quality and reliability. Whether you need bearings, hubs, brakes, or any other vital component, we offer exceptional performance and durability. These parts are readily available through Lippert, CURT, or one of our many distribution partners across the country.

See pages 306 and 307 for a select listing of retail packaged part numbers.

Contact your sales representative for more details on our full line of axle products.

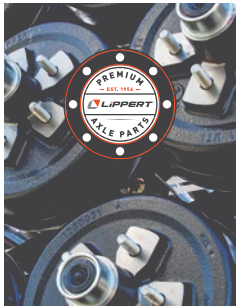

Scan for a digital copy of our full line Axle Parts Catalog

Receive an in-store marketing package with your first qualifying purchase of premium Lippert retail packaged parts!



Header Card (4' or 8')

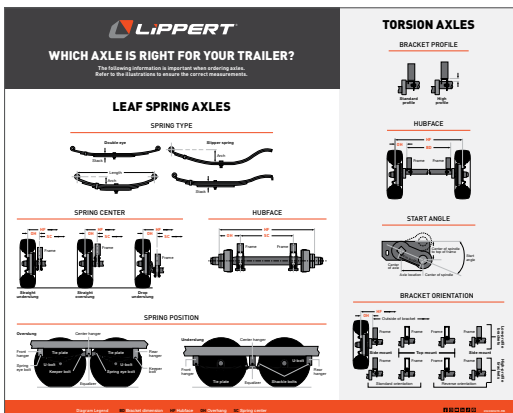

Counter Mat (20" x 16")



Metal Sign (29-1/2")

**GETTING YOU
BACK ON THE
ROAD AGAIN**

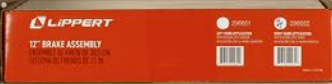

PREMIUM AXLE PARTS RETAIL PROGRAM

NEW



BRAKE ASSEMBLIES

Retail Box #	Brake Size	Vehicle Side	Axle Capacity	Adjust.
297956	10" x 2-1/4"	Driver	3,500 lbs.	Manual
298274	10" x 2-1/4"	Passenger	3,500 lbs.	Manual
296649	10" x 2-1/4"	Driver	3,500 lbs.	Self
296650	10" x 2-1/4"	Passenger	3,500 lbs.	Self
298275	12" x 2"	Driver	4,000 - 8,000 lbs.	Manual
298276	12" x 2"	Passenger	4,000 - 8,000 lbs.	Manual
296651	12" x 2"	Driver	4,000 - 8,000 lbs.	Self
296652	12" x 2"	Passenger	4,000 - 8,000 lbs.	Self

BRAKE & IDLER HUB KITS

Retail Kit #	Axle Capacity	Brake Hub Size	Bolt Pattern	Stud Size
Brake Hubs				
2024013264	3,500 lbs.	10"	5 on 4-1/2"	1/2"
2024013262	6,000 lbs.	12"	6 on 5-1/2"	1/2"
2024013260	7,000 lbs.	12"	8 on 6-1/2"	1/2"
2024013261	7,000 lbs.	12"	8 on 6-1/2"	9/16"
Idler Hubs				
2024013263	3,500 lbs.	--	5 on 4-1/2"	1/2"
2024044866	3,500 lbs.	--	5 on 5"	1/2"

Includes bearing kit (installed) and greased, lubed dust cap, cotter pin, castle nut, washer, lug nuts; in a full color retail box



2023134018



2023134654



2023134658



2023134661



2023134012

GREASE & OIL SEALS

Retail Clamshell #	Axle Capacity	Spindle Shaft Diameter
Grease Seals		
2023134653	2,200 lbs.	1.5"
2023134654	3,500 lbs.	1.719"
2023134655	5,200 - 8,000 lbs.	2.25"
Oil Seals		
2023134018	5,200 - 8,000 lbs.	2.250"
2023134019	10,000 lbs.	2.875"
2023134020	12,000 - 16,000 lbs.	3.125"

STANDARD DUST CAPS

Non Lubed Clamshell #	Lubed Clamshell #	Axle Capacity	Bore Size
Dust Caps			
2023134658	2023134661	2,000 - 3,500 lbs.	2"
2023134659	2023134662	5,200 - 6,000 lbs.	2-1/2"
2023134660	2023134011	7,000 - 8,000 lbs.	2-3/4"
Retail Clamshell #	For Use With		
Dust Cap Rubber Plug			
2023134012	Standard lubed dust caps		



2023133979



2023133984

BEARING KITS

Retail Package Kit #	Axle Capacity
Clamshell	
2023133979	2,000 lbs.
2023133980	3,500 lbs.
2023133981	5,200 lbs.
2023133982	6,000 lbs.
2023133983	7,000 lbs.

Retail Package Kit #	Axle Capacity
Retail Box	
2023133984	8,000 lbs.
2023133985	10,000 lbs.
2023133986	12,000 - 16,000 lbs.



2023134021



2024039634



2023134013

SPINDLE & LUG NUT KITS

Retail Clamshell #	Axle Capacity	Washers Included
Spindle Nut Kits		
2023134656	2,000 - 8,000 lbs.	1" round
2023134657	2,000 - 8,000 lbs.	1" D-flat / 1" locking tang
2023134021	10,000 lbs.	1-1/2" round
2023134022	12,000 - 16,000 lbs.	1-7/8" round
Retail Clamshell #	Type	Thread End
Lug Nut Kits		
2024039632	60° cone wheel	1/2"-20
2024039633	60° cone wheel	9/16"-18
2024039634	Hex flange	5/8"-18
2024039635	Swiveling flange	5/8"-18

WHEEL STUDS

Retail Clamshell #	Shoulder Length	Thread End
2023134013	2"	1/2"-20
2023134014	2-5/16"	9/16"-18



CARGO MANAGEMENT

FEATURED PRODUCTS



Roof rack cargo carrier

CURT cargo carriers are easy to install and offer a simple yet effective solution for adding additional storage space to your vehicle.



Pakka™ cargo caddie

Transform your trunk into a functional, organized space for securing groceries, sports equipment, and more.



Cargo nets

Quick and easy to install, CURT cargo nets offer a reliable way to keep your cargo secure throughout your entire trip.

PRODUCT INDEX



310
Tray-Style
Bike Racks



312
ActiveLink™
System



316
Hitch-Mounted
Bike Racks



318
Bike Rack
Accessories



319
Seat Defender™
Seat Covers



320
Hitch-Mounted
Cargo Carriers



324
Roof Rack
Accessories



327
Pakka™
Cargo Caddie



329
Cargo Straps,
Bags & Nets



330
Extenders
& Adapters



331
Specialty
Mounts



332
Rings & Tie-
Down Anchors



FITS A WIDE VARIETY OF BIKE FRAMES AND TIRE SIZES

2

INCH

ALUMINUM TRAY-STYLE HITCH-MOUNTED BIKE RACK

E-bike compatible

- Padded arms and tray-style cradles keep bikes fully secure with three contact points
- Zero frame contact to avoid nicks and scratches
- Highly adjustable to fit various bike sizes and styles, including e-bikes
- Fits 20-29" diameter wheels, including road tires and fat tires up to 4" wide
- Shank with integrated anti-rattle and lock provides a secure, quiet ride
- Safety trigger latch in handle eliminates unintended release
- Keyed-alike arm safety cable and shank locks for convenient access
- Aluminum-steel construction weighs only 45 lbs.
- Quick, easy 10-bolt assembly
- Tilts away for rear vehicle access and folds up for compact storage
- Durable carbide black powder coat finish
- See page 334 for replacement parts



18088



Ratcheting arms nest below tray for more compact storage and easy handling



Integrated safety cable to secure bikes — keyed alike with anti-rattle



Molded cradles designed to accommodate different bike tire diameters

Part #	Number of Bikes	Max Load	Shank Size	Fits Wheel Diameter	Fits Tire Width
18088	Up to 2	130 lbs.	2"	20" to 29"	Up to 4" wide

1 1/4
INCH

&

2
INCH

STEEL TRAY-STYLE HITCH-MOUNTED BIKE RACKS

- Tray-style cradles provide three points of contact to keep bikes fully secure
- Key-operated ratchets also deter theft while the vehicle is left unattended
- Tray-style design allows for easy loading and unloading of bikes
- Threaded anti-wobble shank helps prevent bikes from swaying
- Padded arms protect the bike frames from nicks and scratches
- Fits both child- and adult-size bikes
- Adapter sleeve allows mounting on 1-1/4" or 2" receiver tubes (#18085 only)
- Removable extension allows for two- or four-bike capacity (#18087 only)
- 4-7/8" (inside width) fat-tire cradles available (#18091)
- Protected by a durable black powder coat finish

• See page 334 for replacement parts



Ratcheting arms lock down onto the frames and will not loosen



Tilts away for convenient rear vehicle access



Folds up when not in use for compact storage



#18091 fat tire cradles replace existing cradles on CURT racks



18085



18087

Part #	Number of Bikes	Max Load	Shank Size	Extendable
Tray-Style Bike Racks				
18085	Up to 2	90 lbs.	1-1/4" x 1-1/4" 2" x 2"	No
18087	Up to 4	180 lbs.	2" x 2"	Yes
Cradles for Fat Tire Bikes				
18091	Includes two cradles	90 lbs.	4-7/8" inside width	

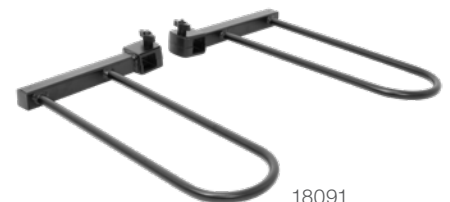

18091



ACTIVELINK™ SERIES

CLICK, LOAD AND GO!

Enjoy your active, outdoor lifestyle with less stress with the CURT ActiveLink™ system. This revolutionary towing technology allows you to swap out any accessory faster and easier than a traditional hitch setup.

Scan to
learn more



How the ActiveLink™ System Works

1. Install the shank just once



Shank provides integrated resting point for struggle-free installation

2. Click in your accessory



Unique connection allows you to easily swap out accessories as needed

3. Insert pin & clip and go!



Patent-pending ActiveLink design for fast, secure attachment with pin and clip

ACTIVELINK™ BIKE RACKS

- Tilt-away feature for easier access to vehicle cargo area
- Anti-rattle hitch pin and anti-rattle hand wheel for reduced noise
- Arms fold down when not in use for compact storage
- Adjustable cradles to accept various frame tube sizes
- Plastic lining on shank helps suppress vibration
- Integrated handle for easy removal and carrying
- Steel construction with dual E-coat and carbide black powder coat finish
- Built-in reflectors on the ends of the arms for increased visibility (#18410, #18411)
- Tiered ascending configuration improves clearance for outer bikes (#18412)
- See page 334 for replacement parts



SE & Ultra series



Rubber bumper pad on vertical support tube to protect from scuffs and scratches

Ultra series only



Flip-back arm allows for better accessibility when loading inner bikes

Ultra series only



Bikes can easily be lifted onto cradles from underneath — no threading needed

Part #	Series Name	Number of Bikes	Capacity	Shank Size
Bike Racks				
18410	SE	Up to 2	90 lbs.	2" included (1-1/4" sold separately, #18401)
18411	SE	Up to 4	180 lbs.	2" included (1-1/4" sold separately, #18401)
18412	Ultra	Up to 4	180 lbs.	2" included (1-1/4" sold separately, #18401)
Shanks				
18401	--	--	3,500 / 350 lbs.	1-1/4"
18402	--	--	5,000 / 500 lbs.	2"



PACK WHAT YOU WANT FOR YOUR NEXT ADVENTURE

ACTIVELINK™ ALUMINUM CARGO CARRIER

- Patent-pending ActiveLink™ design for fast, secure attachment with a pin and clip
- Integrated hook and shank for struggle-free installation
- One-piece welded aluminum basket with durable carbide black powder coat finish
- Weighs only 25 lbs. for easy moving and handling
- Rated to carry loads up to 500 lbs.
- Six-bolt assembly for fast, easy installation
- Spacious design provides ample room for cargo
- Mounts onto any 2" x 2" receiver tube opening
- See page 334 for replacement parts



Integrated eye bolts for secure attachment of straps or other tiedowns



Carrier can be flipped in the shank when not carrying a load for compact transport



Built-in reflectors add visibility for increased safety

Part #	Capacity	Inside Dimensions	Shank Size	Shank	Finish	Material
18415	500 lbs.	49" (L) x 22-1/2" (W) x 4" (H)	2" included	Fixed	Carbide black	Steel and aluminum

ACTIVELINK™ ACCESSORY SHANKS

- Independent shanks for easy swapping on multiple vehicles
- Unique connection allows you to easily swap out accessories as needed
- Patent-pending design for fast, secure accessory attachment with a pin and clip
- Tilt-away feature for easier access to the vehicle cargo area (bike racks only)
- Strong steel construction with dual E-coat and carbide black powder coat for lasting weather resistance
- **See page 334 for replacement parts**



Bottom bolt provides integrated resting point for struggle-free installation



Anti-rattle hitch pin and anti-rattle hand wheel for reduced noise



Plastic interior lining protects against scratches and helps suppress vibration

Part #	GTW / TW	Shank Size	Compatibility
18401	3,500 / 350 lbs.	1-1/4"	ActiveLink series accessories
18402	5,000 / 500 lbs.	2"	ActiveLink series accessories

ACTIVELINK™ BALL MOUNT

- Rated for 3,500 lbs. GTW and 350 lbs. TW
- Quickly and easily mount a 2" tow ball for towing
- Constructed from durable, strong steel
- Includes factory-torqued trailer ball
- Protected with a rust resistant, liquid A-coat
- Finished with a carbide black powder coat
- **See page 334 for replacement parts**



Unique connection allows you to easily swap out accessories as needed

Part #	GTW / TW	Drop	Rise	Fits
18416	3,500 / 350 lbs.	4-1/2"	3"	18401 and 18402 ActiveLink shanks

1 1/4
INCH

&

2
INCH

HITCH-MOUNTED BIKE RACKS

All bike racks

- Arms fold down when not in use for compact storage
- Threaded anti-wobble shank prevents bikes from swaying during travel
- Protected by a durable black powder coat finish

Premium

- Available in 2" shank only
- Built-in reflectors for added safety
- Tapered arms accommodate multiple bike sizes

Standard

- Bolt-together post can be taken apart for compact storage
- Compact package makes part numbers retail-friendly
- Adapter sleeve allows mounting on 1-1/4" or 2" receiver tubes
- Support strap included



Adjustable rubber cradles will not scratch bike frames



Tilts away for convenient rear vehicle access

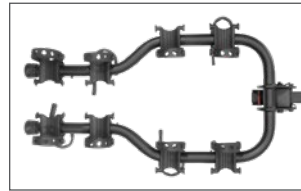

Tapered arms accommodate multiple bike sizes (premium only)



Bolt-on extension arms allow for two- or four-bike capacity



18064



18065



18030



18021

Part #	# of Bikes	Max Bike Capacity	Shank Size	Arm Extensions
Premium Hitch-Mounted Bike Racks				
18064	Up to 4	180 lbs.	2"	Not extendable
18065	Up to 5	225 lbs.	2"	Not extendable
Standard Hitch-Mounted Bike Racks				
18030	Up to 4	90 lbs. without extensions 180 lbs. with extensions	1-1/4" 2"	Included
18021	Up to 2	90 lbs.	1-1/4" 2"	Not included (use #18020)
Extension Arms for #18021 Only				
18020	Adds 2	Adds 90 lbs.	--	--



18020

2 CLAMP-ON BIKE RACK

INCH

- Clamps onto any 2" x 2" ball mount shank (ball mount not included)
- Adjustable rubber cradles will not scratch bike frames
- Easily accessible release handle allows for fast installation and removal
- Folding arms for compact storage
- Safety latch helps prevents pinching and collapse when removing from shank
- Protected by a durable black powder coat finish
- Includes support straps



18013



Clamps onto any 2" accessory shank (not included)



Adjustable rubber cradles will not scratch bike frames



Easily accessible release handle allows for fast install and removal



Built-in reflectors provide added visibility for safety

Part #	Clamp Size	Number of Bikes	Max Load
18013	2" x 2"	Up to 3	135 lbs.

BIKE BEAM

- Allows bike with angled frame to be used on non-tray-style bike racks
- Extends from 22-1/2" to 31" to accommodate multiple bike sizes
- Made with high-strength steel construction

Part #	Length	Finish
18016	Extends from 22-1/2" to 31"	Black



Allows bike with angled frame to be used on bike rack



18016

BIKE RACK SUPPORT STRAP

- Vinyl-coated hook prevents scratches to paint
- Required for all 1-1/4" hitch-mounted bike racks and cargo carriers (Recommended for all hitch-mounted bike racks)
- Failure to use a support strap with a 1-1/4" bike rack may void the warranty of the trailer hitch and bike rack

Part #	Dimensions
18050	1" wide by 61" long



Adds stability and support for a hitch-mounted bike rack



18050

MULTI-USE CABLE LOCK

- 6' length allows for easy locking
- 3/8" high-strength braided steel cable construction
- Includes two keys for added convenience



Secures bike racks and cargo to deter theft



23666

Part #	Length	Cable	Finish
23666	6'	3/8" diameter	Vinyl-coated, braided steel

ANTI-RATTLE HITCH CLAMPS & PINS

Clamp-style

- Stops rattling and prevents shank movement
- Compatible with hollow and solid shank accessories
- No-tool installation and easy-to-adjust clamp lever (#22320 and #22325 only)
- Lightweight aluminum and high-strength steel
- Durable, clear finish for corrosion resistance

Pin-style

- Stops rattling and prevents shank movement
- Compatible with hollow shank accessories
- Protected by a durable yellow zinc-plated finish



22325



22320



45367



22315



22323



Stops rattling and prevents shank movement for hollow and solid shanks (#45367 only)



No-tool installation and easy-to-adjust clamp lever (#22325, #22320 only)



Insert into hollow-shanks to prevent sway and stop rattling (#22315, #22325 only)

Part #	Fits Shank Type	Fits Tube Size	Pin Diameter	Clip Attachment	Finish
Clamps					
22325	Hollow or solid	2" x 2"	--	--	Clear
22320	Hollow or solid	2-1/2" x 2-1/2"	--	--	Clear
45367 N	Hollow or solid	2" x 2"	--	--	Clear
Pins					
22315	Hollow only	1-1/4" x 1-1/4"	1/2"	Hole	Yellow zinc-plated
22323	Hollow only	2" x 2"	5/8"	Groove	Yellow zinc-plated

HITCH ACCESSORY WALL MOUNT

- Simple, multi-function bracket to store cargo carriers, bike racks, ball mounts, and more
- Compatible with virtually any 2" shank hitch accessory
- Also compatible with 1-1/4" accessories in the vertically mounted position



45069



45071



Improves garage organization by keeping accessories off the floor



Horizontal and vertical openings to mount accessories in either orientation



Narrow faceplate allows installation on a 2x4 stud or similar

Part #	Capacity	Shank	Includes	Finish
45069	350 lbs.	2"	Bracket and two lag bolts	Gloss black
45071 N	350 lbs.	2-1/2"	Bracket and two lag bolts	Gloss black

SEAT DEFENDER™ REMOVABLE SEAT COVERS

- Use-as-needed, universal design is easy to install, remove, clean, and store
- 100% waterproof and machine washable (air dry only)
- Allows for side airbag deployment
- Maintains seat belt access (bench seat units may interfere with center shoulder strap)
- XL bench seat model is designed to fit larger bench seats in full-size trucks and SUVs
- Cargo area blanket for picnics, sporting events, working under the car, and more



18501

18500

18502

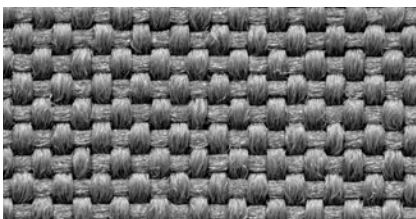

Top is made of durable, woven 600-denier terylene fabric to resist spills and dirt

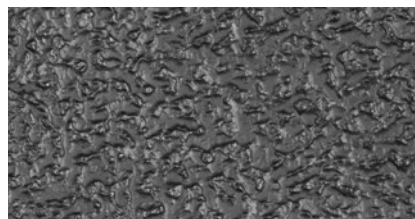

Underside is waterproof rubber to protect against spills and grip the seat for safety

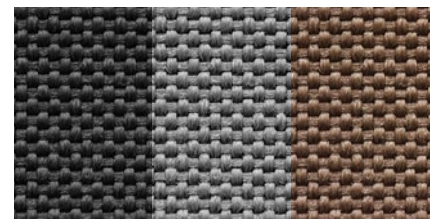

Available in three color options: black, grey, and brown

Location	Width	Height	Black #	Grey #	Brown #
Bucket	23"	58"	18501	18500	18502
Bench	55"	58"	18511	18510	18512
XL bench	63"	58"	18521	18520	18522
Cargo area	60"	60"	18530	--	--



COMPACT, DOUBLE-FOLDING RAMP

ALUMINUM CARGO CARRIER WITH RAMP

- Three-position ramp can be extended, folded vertically or stowed in the carrier
- Double-folding ramp for ergonomic operation and less wind resistance
- Ramp folds flat into the carrier for compact storage and rear vehicle access
- Threaded anti-rattle shank to resist sway and suppress noise
- Non-skid ridges provide enhanced traction when moving up or down the ramp
- Built-in reflectors add visibility for increased safety
- 8-bolt assembly for fast, easy installation
- Fully welded aluminum construction with durable carbide black powder coat finish
- See page 334 for replacement parts



18112



Built-in ramp for easy loading of scooters, push mowers, snow blowers, and more



When not in use, carrier folds up for convenient parking and storage



Six integrated eye bolts for secure attachment of straps or other tiedowns

Part #	Capacity	Inside Dimensions	Shank Size	Shank	Finish	Material
18112	500 lbs.	50" (L) x 30-1/2" (W) x 4" (H)	2" x 2"	Folding	Carbide black	Aluminum

ALUMINUM BASKET-STYLE CARGO CARRIER

- One-piece welded aluminum basket with durable carbide black powder coat finish
- Weighs only 25 lbs. for easy moving and handling
- Rated to carry loads up to 500 lbs.
- 4-bolt assembly for fast, easy installation
- Spacious design provides ample room for cargo
- Four integrated eye bolts for secure attachment of straps or other tiedowns
- Built-in reflectors add visibility for increased safety

• See page 334 for replacement parts



18113



4" tall sides help keep cargo more secure



Rated for 500 lbs. but only weighs 25 lbs.



Built-in reflectors for added safety

Part #	Capacity	Inside Dimensions	Shank Size	Shank	Finish	Material
18113	500 lbs.	49" (L) x 22-1/2" (W) x 4" (H)	2" x 2"	Fixed	Carbide black	Steel and Aluminum

UNIVERSAL ATV CARGO CARRIER

- Universal design fits most ATV cargo racks
- 6" tall sides keep items more secure during travel
- Lightweight for easy installation and use
- Mesh base for easy cleanup
- Heavy-duty, tubular steel with a highly durable E-coat and carbide black powder coat finish
- Includes universal mounting hardware

• See page 334 for replacement parts



18101



Quickly and easily installs onto ATV racks



Adds extra space for securing cargo



6" tall sides keep items more secure

Part #	Capacity	Finish	Material	Inside Dimensions
18101	Limited to ATV	Carbide black	Steel	41" (L) x 26" (W) x 6-1/4" (H)

1 1/4
INCH

&

2
INCH

TRAY-STYLE CARGO CARRIERS

- Easily bolts together for quick assembly
- Mesh base for easy cleanup
- Features mounting holes for a cargo net or bungees
- #18100 is constructed from lightweight aluminum (shank made from powder-coated steel)
- Protected by a highly durable E-coat and carbide black powder coat finish
- See page 334 for replacement parts



Folding design allows carrier to be tilted up when not in use (18100 and 18109 only)



Frees up space inside the vehicle for passengers and cargo

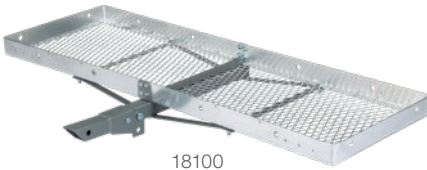

18100

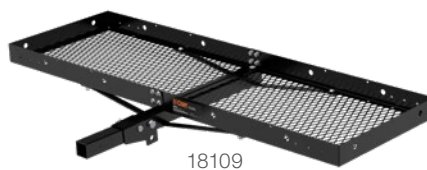

18109



18110

Part #	Capacity	Inside Dimensions	Shank	Shank	Finish and Material
18110	300 lbs.	47-3/4" (L) x 19-1/2" (W) x 2-1/2" (H)	1-1/4" x 1-1/4" 2" x 2" adapter	Fixed	Carbide black powder coat over steel
18100*	500 lbs.	60" (L) x 19" (W) x 2-3/4" (H)	2" x 2"	Folding	Raw aluminum basket with a powder-coated steel shank
18109*	500 lbs.	60" (L) x 19-1/4" (W) x 2-1/2" (H)	2" x 2"	Folding	Carbide black powder coat over steel

* Rear-mounted spare tire may interfere with the folding feature

AUXILIARY LED INDICATOR LIGHTS

- Auxiliary indicator lights for increased safety on cargo carriers or bike racks
- Double row of LEDs in each strip correspond with brake, turn and running lights
- Industry-standard 4-way flat connector for quick installation
- 3M adhesive backing for secure, convenient mounting
- Durable, waterproof construction for lasting weather resistance



53201



Increases safety on cargo carriers



Versatile, stick-on adhesive backing

Part #	Includes
53201	Two LED light strips, adhesive backing and wiring harnesses

1 1/4
INCH

&

2
INCH

BASKET-STYLE CARGO CARRIERS

- Constructed from heavy-duty, tubular steel
- Angled shank elevates carrier for more ground clearance (select models)
- Mesh base for easy cleanup (excl #18145)
- Built-in reflectors add visibility for increased safety
- Easily accepts a cargo bag, cargo net or bungees
- Protected by a highly durable E-coat and carbide black powder coat finish
- See page 334 for replacement parts



6" tall sides keep items more secure during travel



Frees up space inside the vehicle for passengers and cargo



Folding design allows carrier to be tilted up when not in use (select models)



18150



18151



18145



18152



18153

Part #	Capacity	Inside Dimensions	Shank Size	Shank	Finish	Material
18150	500 lbs.	59-1/2" (L) x 20-1/4" (W) x 5-12" (H)	2" x 2"	Fixed	Carbide black	Steel
18151*	500 lbs.	58" (L) x 20" (W) x 5-1/2" (H)	2" x 2"	Folding	Carbide black	Steel
18152	500 lbs.	60" (L) x 24" (W) x 6" (H)	2" x 2"	Fixed	Carbide black	Steel
18153*	500 lbs.	60" (L) x 23-3/4" (W) x 5-1/2" (H)	2" x 2"	Folding	Carbide black	Steel
18145	500 lbs.	46-1/2" (L) x 17-1/2" (W) x 5-1/2" (H)	1-1/4" x 1-1/4" 2" x 2" adapter	Fixed	Carbide black	Steel

* Rear-mounted spare tire may interfere with the folding feature

UNIVERSAL ROOF RACK CROSSBARS

- Lightweight, powder-coated aluminum
- Adjustable, universal design mounts to roof side rails with up to 50" span
- Integrated rubber strip on top of bars to protect and help secure cargo
- Compatible with CURT roof rack cargo carrier and kayak racks



Rubber-coated, key-operated twist knobs for enhanced security



Adjustable, universal design mounts to roof side rails with up to 50" span



Sleek, oval-shaped crossbars to match the OE style of modern vehicles

Part #	Capacity	Length	Width	Height	Includes
18118	150 lbs.	53-3/8"	2-1/8"	7/8" (2" installed)	Two crossbars and mounting hardware

JEEP ROOF RACK CROSSBARS

- Adds rooftop storage space on select hardtop Jeep models (see table below for application)
- Full-width slotted channels for adjustable positioning of straps, hooks or bolts
- Quick-release gutter clamps allow for no-drill, as-needed installation
- Welded steel with a durable carbide black powder coat finish for maximum rust resistance



Adds rooftop storage space on select hardtop Jeep models (see table below)



Full-width slotted channels for adjustable positioning of straps, hooks or bolts



Quick-release, gutter clamps allow for no-drill, as-needed installation

Part #	Years	Years	Capacity	Material	Finish
18119	Jeep Wrangler JK	07 - 18	150 lbs.	Welded steel	Carbide black
18122	Jeep Wrangler JL	18 - 22			
	Jeep Gladiator JT	20 - 22			



EASILY ADJUSTS TO ACCEPT VIRTUALLY ANY SIZE KAYAK

ROOF RACK KAYAK HOLDERS

- Lightweight, powder-coated aluminum
- Notched pivot points for precise positioning and locking
- Universal brackets mount on any roof rack crossbars with no tools required
- Foam padding protects kayaks from scuffs and scratches
- Straps loop around the kayak for secure travel
- Folds flat when not in use for parking in a garage travel
- [See page 334 for replacement parts](#)



Rotating arms pivot to fit virtually any size kayak or paddleboard



Foam padding protects kayaks from scuffs and scratches



Arms fold in seconds for convenient, compact storage in the included bag

Part #	Capacity	Includes
18320	75 lbs.	Two holders, straps and mounting hardware

ROOF RACK CARGO CARRIER

- Frees up space inside the vehicle for passengers and cargo
- Cage-style basket keeps cargo secure and prevents shifting
- Universal brackets allow for easy mounting to most roof rack crossbars
- Lightweight and easy to install with included mounting brackets
- Two-piece design easily bolts together for quick assembly
- Frees up the vehicle interior by providing up to 11 sq. ft. of usable cargo space
- See page 334 for replacement parts

NEW



18123

NEW



18125

NEW



18124



18115



18117



18117 packaging



18115 packaging



Mounts to most roof rack base rails and easily accepts a CURT cargo bag or net



Quick-release bike mount accessory (#18125) allows for easy mounting and transportation of bikes (compatible with #18123 only)

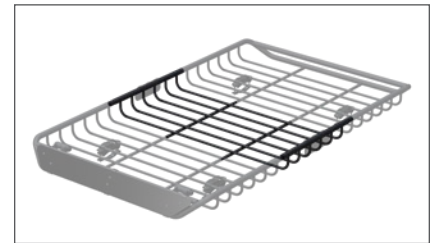

Extension increases the storage area of the cargo basket by up to 6 sq. ft.

Part #	Description	Capacity	Inside Dimensions	Storage Area	Finish	Material
18115*	Roof basket	Limited to vehicle	41-1/2" (L) x 37" (W) x 4" (H)	10-5/8 sq-ft.	E-coat and carbide black	Steel
18117*	Extension	Limited to vehicle	21" (L) x 37" (W) x 4" (H)	Adds 5-3/8 sq-ft.	E-coat and carbide black	Steel
18123 N	Roof basket	Limited to vehicle	44" (L) x 41-1/4" (W) x 3-3/4" (H)	11 sq-ft.	E-coat and carbide black	Steel
18124 N	Extension	Limited to vehicle	21" (L) x 41-1/4" (W) x 3-3/4" (H)	Adds 6 sq-ft.	E-coat and carbide black	Steel
18125 N	Quick-release bike mount	Limited to vehicle	For bicycles with 9mm, 12mm or 15mm forks	--	Zinc-treated	Steel

*Continued while supplies last



CUSTOMIZABLE STORAGE SOLUTIONS

PAKKA™ CARGO CADDIE

NEW

- Adds functional storage space and organization to rear trunk area
- Fits nearly all SUVs and CUVs on the road
- Ideal for compact cargo spaces where rear storage space is limited
- Perfect for groceries, coolers, sports equipment, gym bags and more
- Convenient straps allow for quick adjustments
- 2" high walls help hold items in place during travel



Folded position



Retail packaging



Lightweight, durable molded plastic tray

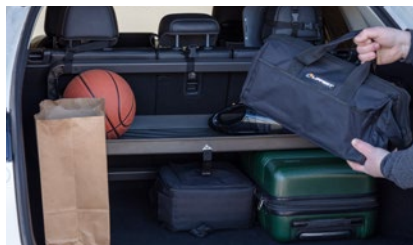

Adjustable height and convenient straps to accommodate different size spaces



Folds up to stow flat when not in use

Part #	Capacity	Inside Tray Dimensions	Material
18425 N	50 lbs.	34" (L) x 14" (W) x 2" (H)	Aluminum frame / plastic tray

CARGO BAGS

- Keeps cargo protected from water, dirt, wind damage and more
- Made from thick, 500 x 500 denier, UV-resistant vinyl
- Zippers feature large holes to accept a padlock
- Tie-down straps securely attach to cargo carrier frame
- Easily folds up for compact storage



Features welded seams to be highly weather-resistant, helping keep cargo dry



Lockable zipper enclosure with hook-and-loop flap helps keep the inside dry



Fits into CURT roof rack cargo carriers and most CURT hitch cargo carriers



18220



18221



18210 & 18211

Part #	Dimensions	Storage	Straps	Description	Yarn Count	Weight	Thickness
18210	56" x 18" x 21"	12.25 cubic feet	6	Cargo carrier bag	500 denier	600 grams per square meter	0.45mm - 0.55mm
18211	56" x 22" x 21"	15.00 cubic feet	6	Cargo carrier bag			
18220	38" x 34" x 18"	13.50 cubic feet	4	Roof rack cargo carrier cargo bag			
18221	59" x 34" x 18"	21 cubic feet	6	Roof rack cargo carrier cargo bag			

CARGO NETS

NEW

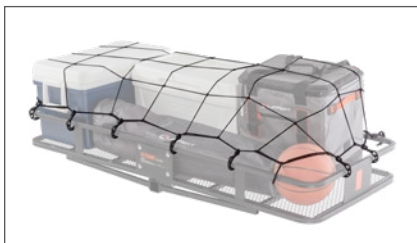

Elastic netting provides better cargo security compared to bungee cords



Attachment hooks feature holes for easy handling and installation

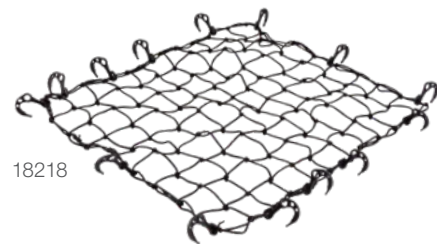

18218

Part #	Dimensions	Fits	Includes
18218 N	44" x 36"	Roof rack cargo carrier	Net and storage bag
18219 N	64" x 36"	Extended roof rack cargo carrier	Net and storage bag
18223 N	43" x 24"	60" wide carriers	Net and storage bag



Netted storage bag

CARGO STRAPS

- Cambuckle mechanism allows for quick, direct tension on lighter loads
- Ratchet mechanism allows for greater tension on heavy loads
- High-strength, woven nylon
- Cinching components protected by a durable yellow zinc-plated finish



Perfect for securing cargo in trailers, truck beds and more



Secures cargo better than bungee cords or rope



83036



83047



83048



83015



83016



83001



83002



83009



83010



83019



83020



83025



83026



83027



83028

Part #	Work Load	Break Strength	Quantity	Color	Length	Width	Hook Style	Hook Finish	Mechanism
83015	300 lbs.	900 lbs.	2	Dark green	15'	1"	S-hook	Rubber-coated	Cambuckle
83016	300 lbs.	900 lbs.	4	Dark green	16'	1"	S-hook	Rubber-coated	Cambuckle
83001	500 lbs.	1,500 lbs.	2	Red	10'	1"	S-hook	Rubber-coated	Ratchet
83002	500 lbs.	1,500 lbs.	4	Red	16'	1"	S-hook	Rubber-coated	Ratchet
83009*	500 lbs.	1,500 lbs.	2	Black	10'	1"	S-hook	Rubber-coated	Ratchet
83010*	500 lbs.	1,500 lbs.	4	Black	16'	1"	S-hook	Rubber-coated	Ratchet
83019	733 lbs.	2,200 lbs.	1	Blue	16'	1"	J-hook	Rubber-coated	Ratchet
83020	733 lbs.	2,200 lbs.	2	Blue	16'	1"	J-hook	Rubber-coated	Ratchet
83027	1,100 lbs.	3,300 lbs.	1	Lime green	16'	1"	S-hook	Rubber-coated	Ratchet
83028	1,100 lbs.	3,300 lbs.	2	Lime green	16'	1"	S-hook	Rubber-coated	Ratchet
83036	1,667 lbs.	5,000 lbs.	1	Yellow	14'	1-1/2"	J-hook	Yellow zinc-plated	Ratchet
83047	3,333 lbs.	10,000 lbs.	1	Yellow	27'	2"	J-hook	Yellow zinc-plated	Ratchet
83048	3,333 lbs.	10,000 lbs.	1	Yellow	27'	2"	Flat hook	Yellow zinc-plated	Ratchet

* Continued while supplies last

CAUTION: Use of adapters and extenders can reduce tongue weight or vertical load capacity of the vehicle's hitch. Products under 12" reduce load capacity by 25%. Products over 12" reduce load capacity by 50%.

2
INCH

&

2½
INCH

&

3
INCH

TRAILER HITCH RECEIVER TUBE ADAPTERS & EXTENDERS

Adapters

- Adapts a receiver tube opening to a different size
- #45048 can be cut down from 34" to 24" and has integrated safety chain loops and electrical bracket

Extenders

- Solid steel shank for optimum strength

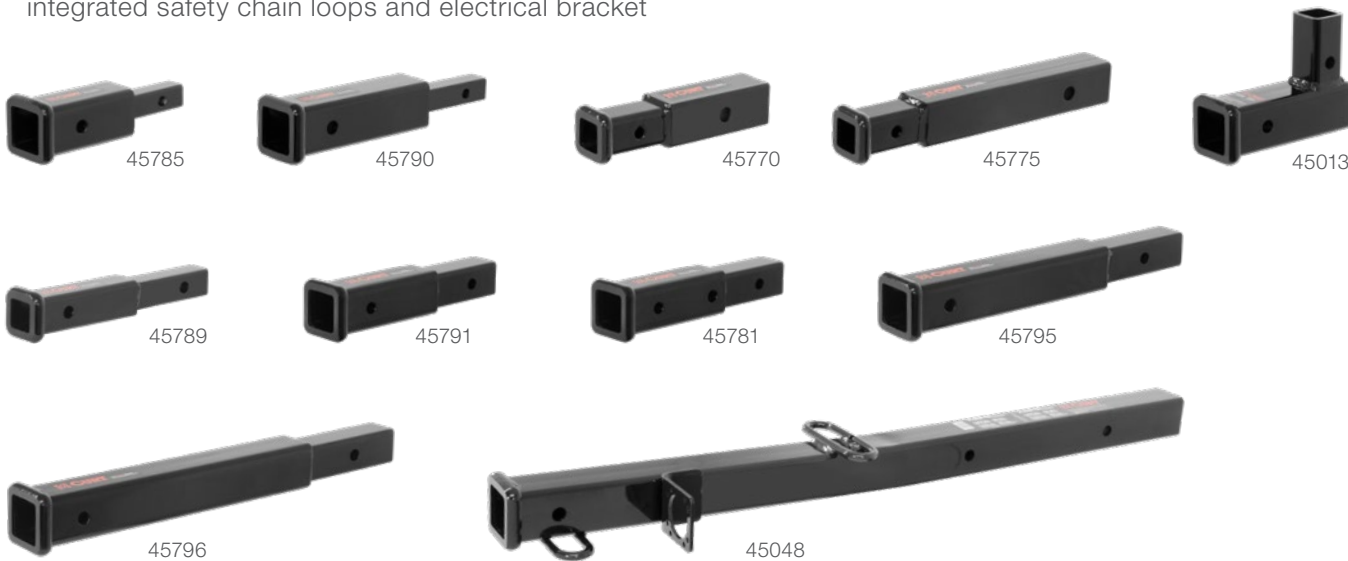

Adds clearance for a trailer or hitch-mounted accessory (45791)



Moves coupling point farther from the vehicle to avoid obstructions

Measuring adapters and extenders



Length is measured between pin-holes, from center to center

Part #	Adapts From	Adapts To	GTW / TW	Weight Dist. GTW / TW	Length	Finish
Adapters						
45785	1-1/4"	2"	Not for towing use / 350 lbs.	--	6-1/4"	Gloss black
45790	1-1/4"	2"	Not for towing use / 350 lbs.	--	10"	Gloss black
45770	2"	1-1/4"	3,500 / 350 lbs.	--	4"	Gloss black
45775	2"	1-1/4"	3,500 / 350 lbs.	--	9-1/2"	Gloss black
45013	Vertical 2"	Standard 2"	5,000 / 500 lbs.	--	4-1/4"	Gloss black
45048	2-1/2"	2"	4,500 / 450 lbs. 6,000 / 600 lbs.	6,000 / 600 lbs. 8,000 / 800 lbs.	34" 24"	Gloss black
Extenders						
45789	--	--	Not for towing use / 350 lbs.	--	7"	Gloss black
45791	--	--	3,500 / 350 lbs.	--	8"	Gloss black
45781*	--	--	3,500 / 350 lbs.	--	8"	Gloss black
45795	--	--	3,500 / 350 lbs.	--	14"	Gloss black
45796	--	--	3,500 / 350 lbs.	--	18"	Gloss black

* Hollow shank

2 SPECIALIZED ADAPTERS

- Fits any 2" x 2" receiver tube opening
- Top receiver increases ground clearance for a cargo carrier or other hitch-mounted accessories
- Top receiver not for towing use
- Provides two receiver tubes for multiple accessories, such as a cargo carrier and a ball mount (#45792)
- Ideal for carrying a bike rack while towing a trailer (#45810)



45794 provides added ground clearance



45792 provides two receiver tubes



45810 provides a ball mount and receiver tube to tow a trailer and an additional accessory



Part #	Description	GTW / TW	Drop	Rise	Length	Hole Size	Finish
45794	Raised receiver adapter (only for use in the rise position)	Not for towing use / 350 lbs.	--	4-1/4"	5-1/4"	--	Gloss black
45792	Dual receiver extender with pin & clip	3,500 / 350 lbs.	--	5-13/16"	8"	--	Gloss black
45810	Multi-use ball mount with pin & clip	7,500 / 750 lbs.	2"	5-13/16"	12-1/4"	1"	Gloss black

3 INCH → 2 1/2 INCH → 2 INCH REDUCER SLEEVES

- #45408 set reduces a 3" receiver tube opening to fit a 2" or 2-1/2" shank
- Limited to trailer hitch capacity



45405 - single



45408 - nested set



45409



45408 set includes two reducers to fit multiple accessories



Reduces the receiver tube opening to fit smaller shank sizes

Part #	Reduces From	Reduces To	Length	Finish
45405	2-1/2"	2"	5-1/2"	Carbide black
45409	3"	2-1/2"	6-1/4"	Carbide black
45408*	3"	2-1/2"	6-1/4"	Carbide black
	2-1/2"	2"		

* 2-1/2" to 2" inner sleeve only designed for 2-1/2" receiver tubes with 2-1/4" from the collar to the hitch pin hole

How to use a reducer sleeve

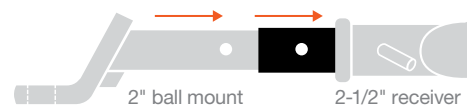

RINGS & TIE-DOWN ANCHORS

See adjacent page
for part number table

Recessed rope rings

- Recessed design eliminates obstruction and provides a finished look
- Constructed from high-strength steel
- Mounting screws not included



83601



83710



83600

D-rings

- Constructed from high-strength steel
- Mounting screws not included



83740



83742



83732



83730



83731 two-pack

Backing plate

- Adds strength to tie-down anchors
- Constructed from high-strength steel
- Compatible with #83600, #83740 and #83742
- Mounting screws not included



83607



83740 & 83607

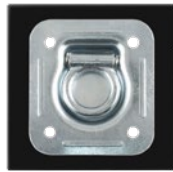

83600 & 83607

Trim ring

- Provides a clean, finished look for recessed plate #83710
- Helps protect plate edges from damage and corrosion



83720



83710 in 83720

Lashing rings

- Heavy-duty design with large opening offers a reliable anchoring point
- Raw finish allows for ready welding of mounting bracket
- Constructed from high-strength, forged steel



83750



83760



83770



83780

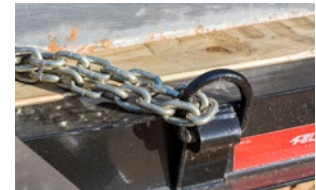

Adds attachment point to a trailer

RINGS & TIE-DOWN ANCHORS

Part #	Capacity	Break Strength	Finish	Base Size	Mount Hole Size	Mounting Hole Pattern	Ring I.D.	Ring Thickness
Recessed Rope Rings								
83710	1,000 lbs.	1,000 lbs.	Zinc-plated	3-1/2" x 3-1/2"	1/4"	1-3/16"	1-1/8" x 1-5/8"	1/4"
83601	1,200 lbs.	1,200 lbs.	Zinc-plated	5" x 3-1/2"	1/4"	4-1/16" x 1/4"	1-3/8" x 1-7/8"	1/4"
83600	5,000 lbs.	7,000 lbs.	Zinc-plated	4-7/8" x 4-1/2"	3/8"	3-3/8" x 2-7/8"	1-1/2" x 1-1/2"	1/2"
D-Rings								
83730	1,200 lbs.	2,400 lbs.	Zinc-plated	2-1/4" x 13/16"	1/4"	1-1/2"	1" x 1-1/4"	1/4"
83731*	1,200 lbs.	2,400 lbs.	Zinc-plated	2-1/4" x 13/16"	1/4"	1-1/2"	1" x 1-1/4"	1/4"
83732	1,200 lbs.	2,400 lbs.	Stainless	2-1/4" x 13/16"	1/4"	1-1/2"	1" x 1-1/4"	1/4"
83740	3,600 lbs.	11,000 lbs.	Yellow zinc-plated	1-3/4" x 3-11/16" x 7/8"	7/16" square	2"	3" x 3"	1/2"
83742	3,600 lbs.	11,000 lbs.	Zinc-plated	1-3/4" x 3-11/16" x 7/8"	7/16" square	2"	3" x 3"	1/2"
Backing Plate and Trim Ring								
83720	--	--	Plastic	--	--	--	3" x 3"	3/8"
83607	--	--	Gloss black	6" x 6"	7/16"	3" x 3-1/4" (2" center)	--	--
Lashing Rings								
83750	6,100 lbs.	18,000 lbs.	Raw steel	2-1/4" x 1-5/8" x 1-1/4"	--	--	3" x 3"	5/8"
83760	8,833 lbs.	26,500 lbs.	Raw steel	2-1/4" x 1-5/8" x 1-1/4"	--	--	3" x 3"	3/4"
83770	15,587 lbs.	46,760 lbs.	Raw steel	2-1/4" x 2-1/8" x 1-3/4"	--	--	3" x 3"	1"
83780	15,587 lbs.	47,000 lbs.	Raw steel	2-1/4" x 2-1/8" x 1-3/4"	--	--	3" x 4"	1"

* Packaged two-pack

FOLD-AWAY ROPE HOOK

- Fold-away design eliminates obstruction and provides a finished look
- Includes mounting hardware



Folds out as needed and folds away to be unobtrusive



83060 83061

WELD-ON STAKE POCKET

- Perfectly sized to accept a 2x4 wood or metal stud
- Raw finish allows for ready welding
- Made in the USA



83072

Bulk #	Pkg #	Capacity	Finish
83060	83061	1,200 lbs.	Chrome-plated

Part #	Finish	Height	Thickness	Inside Width	Inside Depth
83072	Raw	3"	3/16"	3-1/2"	1-5/8"

REPLACEMENT PARTS

ACTIVELINK™ SERIES



Part #	Description	Fits
19234	Safety reflectors, qty 2	18415
19244	18" velcro straps, qty 4	18410, 18411, 18412
19246	Standard frame cushion slip-on pads, qty 2	18410, 18411
19247	Reflector caps, qty 2	18410, 18411
19249	Underslung frame cushion kit - Pads, qty 2 - M10 x 45mm bolts, qty 2 - M10 nylock nuts, qty 2 - M10 flat washers, qty 2	18412
19245	Orange shank sleeve, qty 1	18401, 18402

Part #	Description	Fits
19248	Clevis pin with lanyard, qty 1	18401, 18402, 18410, 18411, 18412
19268	Shank hardware kit - M12 x 85mm bolt, qty 1 - M12 nylock nut, qty 1 - M12 flat washer, qty 1 - 1/2" anti-rattle bolt, qty 1 - 1/2" flat washer, qty 1 - 1/2" lock washer, qty 1 - Anti-rattle clip, qty 1 - Clevis pin with lanyard, qty 1 - Hand wheel, qty 1	18401, 18402

ALUMINUM TRAY-STYLE BIKE RACK



Part #	Description	Fits
19264	Wheel cradle kit - Wheel cradle, qty 1 - M8 x 35mm bolts, qty 2 - M8 nylock nuts, qty 2	18088
19265	Tire strap, qty 1	18088
19266-01	Keys - 201, qty 2	18088
19266-02	Keys - 301, qty 2	18088
19266-03	Keys - 202, qty 2	18088
19266-04	Keys - 302, qty 2	18088
19266-05	Keys - 203, qty 2	18088
19266-06	Keys - 303, qty 2	18088
19267	Tray end-caps, qty 2	18088

STEEL TRAY-STYLE BIKE RACKS

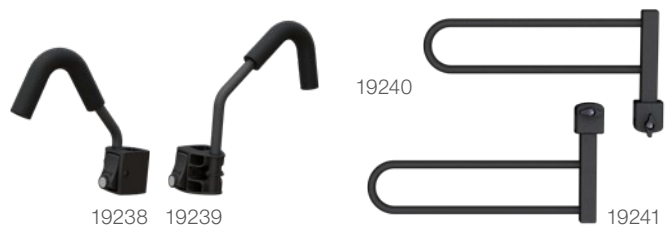

Part #	Description	Fits
19238	Short locking arm, qty 1	18085, 18087
19239	Long locking arm, qty 1	18085, 18087
19240	Right support arm, qty 1	18085, 18087
19241	Left support arm, qty 1	18085, 18087

HITCH-MOUNTED BIKE RACKS



Part #	Description	Fits
18007	Rubber cradle straps, qty 2	18020, 18021, 18030, 18064, 18065
19290	Anti-rattle bolt kit, qty 1	

ROOF RACK KAYAK HOLDERS



Part #	Description	Fits
19235	1" x 9-1/2' tie down straps, qty 2	18320

CARGO CARRIERS

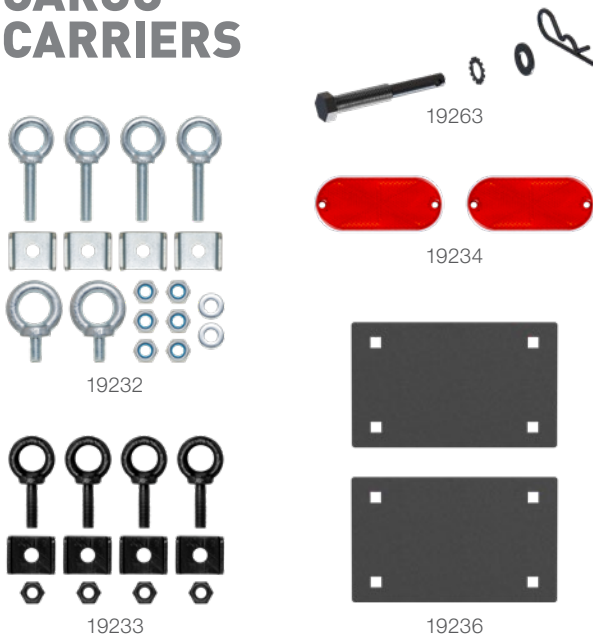

Part #	Description	Fits
19232	Eye-bolt hardware kit - U-clips, qty 4 - M10 lock nuts, qty 6 - M10 x 45mm eye-bolts, qty 4 - M10 x 20mm eye-bolts, qty 2 - M10 flat washers, qty 2	18112
19233	Eye-bolt hardware kit - U-clips, qty 4 - M10 x 45mm eye-bolts, qty 4 - M10 lock nuts, qty 4	18113
19263	Anti-rattle hitch pin & clip, qty 1	18112
19234	Reflectors, qty 2	18112, 18113
19236	Basket assembly plates, qty 2	18150, 18151, 18152, 18153

ROOF RACK CARGO CARRIER

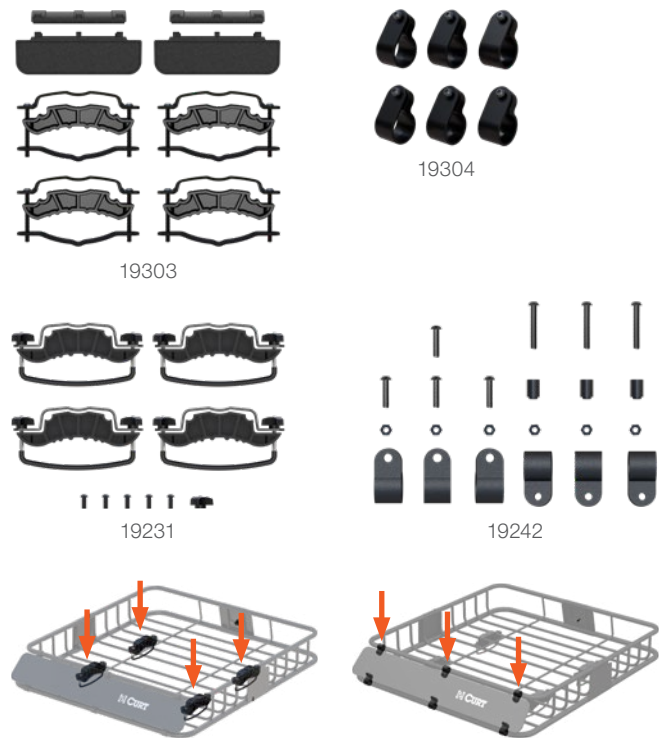

Part #	Description	Fits
19231	Roof rail hardware kit - Bracket plates, qty 4 - Bracket saddles, qty 4 - Knobs, qty 9 - M6 x 16mm bolts, qty 4 - M6 x 25mm bolts, qty 1 - U-bolts, qty 4	18115
19242	Fairing hardware kit - Small clips, qty 3 - Large clips, qty 3 - Plastic spacers, qty 3 - M6 x 25mm bolts, qty 4 - M6 x 40mm bolts, qty 3 - M6 lock nuts, qty 6	18115
19303	Roof rack hardware kit	18123
19304	Fairing hardware kit	18123



MARKETING SUPPORT

CURT UNIVERSITY

CURT University is a self-service learning tool for CURT products and resources and provides easy access to nearly all of our marketing support materials. It is designed to educate our customers to enhance their sales and grow their business!



Scan or visit
curtmfg.com/university

POINT-OF-PURCHASE



Catalog



Poster

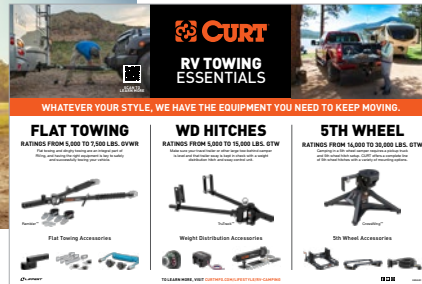

Counter mat



Trailer hitch display stand

Literature & Catalog

- Accordion-fold literature educates the consumer about the advantages of CURT product lines
- Accordion-fold: 8-1/2" x 3-1/2" finished size

Banners & Posters

- Bold graphics and clear lifestyle messaging to draw attention to your store
- Various options designed to promote your CURT product offering while educating your customers

Retail Signage

- Window stickers, indoor / outdoor signage and counter mats to help promote CURT products
- Header cards also available

Displays & Signage

- We offer a number of custom-built displays to furnish your store and showcase our products
- Choose from floor and countertop options
- 48" x 8" Lozier-ready header cards also available

PLANOGRAM SUPPORT

In-Store Planograms

CURT offers custom planogram services tailored to your needs. Whether pre-designed or custom, we can help provide a convenient retail solution for your store.

Please contact your sales representative for more information about sizes and options or to discuss custom planogram options.

Contact your sales representative for a complete list of available items and how to qualify.

TRAILER HITCHES & BASE PLATES LISTED NUMERICALLY

Part #	Years	Make / Model	Pallet Qty	Part #	Years	Make / Model	Pallet Qty	Part #	Years	Make / Model	Pallet Qty
11000	10-14	VOLKSWAGEN GOLF	40	11174	01-05	BMW 325CI	50	11290	01-03	ACURA CL	50
11000	10-14	VOLKSWAGEN GTI	40	11174	01-05	BMW 325I	50	11290	99-03	ACURA TL	50
11001	10-16	MERCEDES-BENZ E350	13	11174	01-05	BMW 325XI	50	11290	98-07	HONDA ACCORD	50
11002	10-11	HONDA ACCORD CROSSTOUR	30	11174	99-00	BMW 328I	50	11291	12-15	SCION IQ	28
11002	12-15	HONDA CROSSTOUR	30	11174	01-05	BMW 330CI	50	11292	01-05	KIA RIO	40
11006	07-12	DODGE CALIBER	40	11174	01-05	BMW 330I	50	11294	00-07	FORD FOCUS	38
11020	08-15	SMART FORTWO	26	11174	01-05	BMW 330XI	50	11296	01-07	FORD FOCUS	32
11025	11-14	HYUNDAI SONATA	30	11181	98-02	CHEVROLET PRIZM	60	11302	11-17	NISSAN JUKE	26
11025	11-15	KIA OPTIMA	30	11181	93-97	GEO PRIZM	60	11303	11-16	HYUNDAI ELANTRA	34
11028	06-15	MAZDA MX-5 MIATA	13	11181	93-02	TOYOTA COROLLA	60	11303	13-14	HYUNDAI ELANTRA COUPE	34
11030	12-13	MERCEDES-BENZ C250	13	11184	11-11	BMW 1 SERIES M	24	11306	07-11	CHEVROLET AVE05	48
11030	08-13	MERCEDES-BENZ C300	13	11184	08-11	BMW 128I	24	11306	09-10	PONTIAC G3	48
11030	08-13	MERCEDES-BENZ C350	13	11184	08-11	BMW 135I	24	11307	03-13	CADILLAC CTS	32
11030	08-13	MERCEDES-BENZ C63 AMG	13	11186	09-16	AUDI A4	24	11307	05-11	CADILLAC STS	32
11031	07-10	KIA RONDO	26	11186	09-16	AUDI A4 QUATTRO	24	11311	13-19	CADILLAC ATS	16
11033	07-08	BMW 328XI	13	11187	95-02	CHRYSLER SEBRING	24	11312	05-08	FORD MUSTANG	36
11033	07-08	BMW 335XI	13	11187	95-00	DODGE AVENGER	24	11315	08-11	SUBARU IMPREZA	26
11034	97-04	CHEVROLET CORVETTE	40	11187	01-02	DODGE STRATUS	24	11317	08-14	SUBARU IMPREZA	24
11037	08-16	AUDI A5 QUATTRO	28	11188	10-16	AUDI A5	24	11318	05-06	SAAB 9-2X	60
11041	94-04	FORD MUSTANG	22	11188	08-16	AUDI A5 QUATTRO	24	11318	93-07	SUBARU IMPREZA	60
11048	10-11	FORD MUSTANG	36	11192	06-13	AUDI A3	40	11319	08-11	FORD FOCUS	13
11054	98-05	VOLKSWAGEN PASSAT	45	11195	09-12	AUDI A4 QUATTRO	20	11321	04-08	ACURA TL	35
11058	07-08	HONDA FIT	50	11195	13-16	AUDI ALLROAD	20	11325	06-10	HYUNDAI SONATA	36
11064	09-13	HONDA FIT	24	11197	12-16	AUDI A7 QUATTRO	22	11326	03-11	SAAB 9-3	22
11065	11-13	VOLVO C70	30	11198	04-09	HONDA S2000	22	11327	03-07	HONDA ACCORD	32
11066	98-10	VOLKSWAGEN BEETLE	50	11200	11-17	LEXUS CT200H	30	11328	13-15	MITSUBISHI LANCER	30
11066	99-06	VOLKSWAGEN GOLF	50	11202	09-14	NISSAN CUBE	30	11329	06-09	FORD FUSION	24
11066	07-10	VOLKSWAGEN GOLF CITY	50	11204	01-05	HONDA CIVIC	30	11329	07-09	LINCOLN MKZ	24
11067	11-19	FORD FIESTA	22	11207	97-00	ACURA EL	36	11329	06-06	LINCOLN ZEPHYR	24
11070	99-05	VOLKSWAGEN JETTA	50	11207	92-00	HONDA CIVIC	36	11329	06-08	MAZDA 6	24
11073	11-14	MAZDA 2	26	11209	92-00	HONDA CIVIC	30	11329	06-09	MERCURY MILAN	24
11074	06-09	VOLKSWAGEN GTI	24	11210	11-14	FORD MUSTANG	24	11331	07-11	CHEVROLET AVEO	30
11074	06-09	VOLKSWAGEN RABBIT	24	11211	95-98	HONDA ODYSSEY	48	11333	11-16	MINI COOPER COUNTRYMAN	32
11076	00-05	VOLKSWAGEN PASSAT	30	11211	96-99	ISUZU OASIS	48	11334	13-15	CHEVROLET SPARK	36
11077	11-16	HONDA CR-Z	44	11214	95-05	HYUNDAI ACCENT	48	11338	06-10	MAZDA 5	32
11083	01-05	VOLKSWAGEN JETTA	30	11216	99-01	HYUNDAI SONATA	60	11344	06-11	AUDI A6	20
11085	11-14	ACURA TSX	28	11216	01-05	KIA OPTIMA	60	11344	05-11	AUDI A6 QUATTRO	20
11085	08-12	HONDA ACCORD	28	11221	11-15	CHEVROLET VOLT	26	11347	12-19	FIAT 500	20
11086	10-16	HYUNDAI GENESIS COUPE	20	11222	11-15	CHEVROLET CAMARO	40	11348	07-12	NISSAN VERSA	36
11087	11-13	SCION TC	28	11234	12-22	VOLKSWAGEN PASSAT	20	11349	13-22	NISSAN SENTRA	24
11088	11-17	NISSAN JUKE	32	11239	83-92	MAZDA 626	40	11351	06-08	KIA MAGENTIS	48
11090	07-16	VOLKSWAGEN EOS	32	11239	88-92	MAZDA MX-6	40	11351	06-10	KIA OPTIMA	48
11091	09-17	VOLKSWAGEN CC	24	11240	12-20	CHEVROLET SONIC	22	11352	07-25	NISSAN ALTIMA	32
11091	06-10	VOLKSWAGEN PASSAT	24	11250	12-17	HYUNDAI ACCENT	30	11352	09-23	NISSAN MAXIMA	32
11094	06-11	HYUNDAI ACCENT	24	11250	12-17	KIA RIO	30	11354	12-19	VOLKSWAGEN BEETLE	28
11094	06-11	KIA RIO	24	11254	12-17	HYUNDAI VELOSTER	20	11356	14-21	MAZDA 6	22
11103	07-10	JEEP GRAND CHEROKEE	45	11255	95-96	NISSAN MAXIMA	40	11362	13-18	LEXUS ES300H	46
11110	10-13	KIA SOUL	34	11256	12-19	NISSAN VERSA	24	11362	13-18	LEXUS ES350	46
11117	82-02	CHEVROLET CAMARO	28	11257	91-94	NISSAN SENTRA	26	11363	12-19	FIAT 500	24
11117	82-02	PONTIAC FIREBIRD	28	11258	12-16	CHEVROLET SONIC	20	11366	18-19	LEXUS GS300	26
11120	08-14	SUBARU IMPREZA	28	11260	12-15	VOLKSWAGEN BEETLE	26	11366	13-20	LEXUS GS350	26
11126	02-08	MINI COOPER	30	11261	97-98	NISSAN 200SX	44	11367	14-16	BMW 228I	26
11127	12-15	MAZDA 5	24	11261	97-99	NISSAN SENTRA	44	11367	15-16	BMW 228I XDRIVE	26
11128	98-98	CHEVROLET TRACKER	52	11262	12-17	KIA RIO	44	11367	17-21	BMW 230I	26
11128	89-97	GEO TRACKER	52	11264	02-06	NISSAN ALTIMA	24	11367	17-21	BMW 230I XDRIVE	26
11128	89-98	SUZUKI SIDEKICK	52	11264	04-08	NISSAN MAXIMA	24	11367	13-18	BMW 320I	26
11132	01-10	CHRYSLER PT CRUISER	40	11265	03-19	TOYOTA COROLLA	60	11367	13-18	BMW 320I XDRIVE	26
11133	11-14	CHRYSLER 200	28	11276	10-15	TOYOTA PRIUS	40	11367	14-18	BMW 328D	26
11133	11-14	DODGE AVENGER	28	11276	12-15	TOYOTA PRIUS PLUG-IN	40	11367	14-18	BMW 328D XDRIVE	26
11134	11-14	SCION XD	50	11276	12-17	TOYOTA PRIUS V	40	11367	11-16	BMW 328I	26
11141	96-05	TOYOTA RAV4	32	11278	12-14	CHEVROLET ORLANDO	26	11367	11-16	BMW 328I XDRIVE	26
11158	12-18	FORD FOCUS	48	11280	03-06	SUBARU BAJA	60	11367	17-18	BMW 330I	26
11159	96-04	ACURA RL	24	11281	13-16	DODGE DART	26	11367	14-16	BMW 335I GT XDRIVE	26
11160	07-11	MINI COOPER	44	11282	12-17	BUICK VERANO	30	11367	13-15	BMW 335I XDRIVE	26
11164	02-08	AUDI A4	50	11282	11-15	CHEVROLET CRUZE	30	11367	16-18	BMW 340I	26
11164	02-08	AUDI A4 QUATTRO	50	11285	92-95	TOYOTA PASEO	26	11367	16-18	BMW 340I XDRIVE	26
11164	04-08	AUDI S4	50	11286	12-16	SUBARU IMPREZA	26	11367	14-18	BMW 428I	26
11164	03-04	VOLKSWAGEN PASSAT	50	11286	13-15	SUBARU XV CROSSTREK	26	11367	15-16	BMW 428I GRAN COUPE	26
11174	00-00	BMW 323CI	50	11289	00-05	TOYOTA CELICA	32	11367	14-16	BMW 428I XDRIVE	26
11174	99-00	BMW 323I	50	11289	00-05	TOYOTA ECHO	32	11367	15-16	BMW 428I XDRIVE GRAN COUPE	26

Part #	Years	Make / Model	Pallet Qty
11367	17-20	BMW 430I	26
11367	17-20	BMW 430I GRAN COUPE	26
11367	17-20	BMW 430I XDRIVE	26
11367	17-20	BMW 430I XDRIVE GRAN COUPE	26
11367	14-16	BMW 435I	26
11367	15-16	BMW 435I GRAN COUPE	26
11367	14-16	BMW 435I XDRIVE	26
11367	15-16	BMW 435I XDRIVE GRAN COUPE	26
11367	17-20	BMW 440I	26
11367	17-20	BMW 440I GRAN COUPE	26
11367	17-20	BMW 440I XDRIVE	26
11367	17-20	BMW 440I XDRIVE GRAN COUPE	26
11367	17-20	BMW M240I	26
11367	17-20	BMW M240I XDRIVE	26
11368	14-18	KIA FORTE	24
11369	13-16	FORD FIESTA	30
11370	07-12	NISSAN SENTRA	40
11371	14-15	CHEVROLET CRUZE	24
11372	06-06	LEXUS GS300	24
11372	07-11	LEXUS GS350	24
11372	06-07	LEXUS GS430	24
11372	06-13	LEXUS IS250	24
11372	06-12	LEXUS IS350	24
11375	14-16	SCION TC	24
11377	14-18	MAZDA 3	30
11378	14-19	NISSAN VERSA NOTE	24
11379	13-16	SCION FR-S	20
11379	13-20	SUBARU BRZ	20
11379	17-20	TOYOTA 86	20
11380	05-13	CHEVROLET CORVETTE	20
11381	11-16	BMW 535I	24
11381	11-16	BMW 535I XDRIVE	24
11381	11-16	BMW 550I	24
11381	11-14	BMW 550I XDRIVE	24
11382	14-15	CADILLAC CTS	24
11383	10-13	MAZDA 3	32
11386	04-09	MAZDA 3	30
11387	08-14	MINI COOPER	30
11389	16-17	LEXUS IS200T	30
11389	14-15	LEXUS IS250	30
11389	16-20	LEXUS IS300	30
11389	14-20	LEXUS IS350	30
11390	10-12	FORD FUSION	36
11390	10-12	LINCOLN MKZ	36
11390	10-11	MERCURY MILAN	36
11391	06-11	ACURA CSX	40
11391	13-22	ACURA ILX	40
11391	06-15	HONDA CIVIC	40
11393	10-13	MAZDA 3	30
11394	14-24	MINI COOPER	22
11396	11-17	NISSAN LEAF	30
11398	13-16	CHEVROLET SONIC	22
11399	15-20	AUDI A3	40
11399	15-20	AUDI A3 QUATTRO	40
11400	13-17	HYUNDAI ELANTRA GT	50
11402	15-19	HYUNDAI SONATA	30
11402	16-20	KIA OPTIMA	30
11403	15-17	CHRYSLER 200	24
11405	15-23	FORD MUSTANG	22
11406	15-20	HONDA FIT	28
11407	14-24	INFINITI Q50	20
11408	12-16	SUBARU IMPREZA	36
11408	15-21	SUBARU WRX	36
11408	15-21	SUBARU WRX STI	36
11410	15-15	VOLKSWAGEN JETTA	16
11411	15-15	VOLKS. GOLF SPORTWAGEN	20
11412	15-21	VOLKSWAGEN GOLF	52
11412	15-24	VOLKSWAGEN GTI	52
11413	16-16	MERCEDES-BENZ E350	36
11416	16-22	HONDA HR-V	24
11417	14-19	MINI COOPER	30
11418	16-21	MAZDA CX-3	30
11419	14-17	KIA SOUL	28
11420	16-16	SCION IM	24

Part #	Years	Make / Model	Pallet Qty
11420	17-18	TOYOTA COROLLA IM	24
11421	16-16	SCION IA	24
11421	17-18	TOYOTA YARIS IA	24
11422	17-19	VOLKSWAGEN GOLF ALLTRACK	40
11422	15-19	VOLKS. GOLF SPORTWAGEN	40
11423	12-16	AUDI A6	28
11423	12-16	AUDI A6 QUATTRO	28
11424	17-18	HYUNDAI ELANTRA	28
11425	15-15	CHEVROLET CRUZE	24
11425	16-16	CHEVROLET CRUZE LIMITED	24
11427	05-12	TOYOTA AVALON	8
11430	05-10	CHEVROLET COBALT	44
11430	05-06	PONTIAC PURSUIT	44
11431	13-18	FORD FOCUS	24
11433	16-22	CHEVROLET SPARK	24
11434	10-13	KIA FORTE	30
11435	16-22	MAZDA MX-5 MIATA	24
11436	16-19	CHEVROLET VOLT	32
11438	04-12	VOLVO S40	40
11438	05-11	VOLVO V50	40
11439	16-19	CHEVROLET CRUZE	24
11441	16-19	BUICK CASCADA	32
11442	05-06	NISSAN X-TRAIL	30
11447	05-10	CHEVROLET COBALT	28
11447	06-11	CHEVROLET HHR	28
11447	07-10	PONTIAC G5	28
11447	05-06	PONTIAC PURSUIT	28
11447	04-07	SATURN ION	28
11448	17-20	AUDI A4	24
11448	17-22	AUDI A4 ALLROAD	24
11448	17-24	AUDI A4 QUATTRO	24
11448	18-23	AUDI A5 QUATTRO	24
11448	18-22	AUDI A5 SPORTBACK	24
11448	18-22	AUDI S5	24
11448	18-22	AUDI S5 SPORTBACK	24
11449	17-20	MINI COOPER	24
11453	15-17	NISSAN MICRA	24
11454	17-19	MERCEDES-BENZ E300	32
11454	20-23	MERCEDES-BENZ E350	32
11454	17-19	MERCEDES-BENZ E400	32
11454	20-23	MERCEDES-BENZ E450	32
11455	04-08	ACURA TSX	16
11457	17-23	CHEVROLET BOLT EV	36
11458	17-19	CHEVROLET CRUZE	24
11462	07-12	MINI COOPER	30
11463	16-18	HONDA CIVIC	30
11464	17-20	CHEVROLET SONIC	24
11465	17-23	SUBARU IMPREZA	26
11466	17-23	SUBARU IMPREZA	24
11467	07-10	HYUNDAI ELANTRA	60
11468	04-09	TOYOTA PRIUS	36
11471	09-12	HYUNDAI ELANTRA	32
11473	16-22	TOYOTA PRIUS	24
11473	19-22	TOYOTA PRIUS AWD-E	24
11473	17-22	TOYOTA PRIUS PRIME	24
11474	10-14	VOLKSWAGEN GOLF	24
11474	05-18	VOLKSWAGEN JETTA	24
11477	03-08	HYUNDAI TIBURON	30
11478	17-23	BMW 530I	24
11478	17-23	BMW 530I XDRIVE	24
11478	17-23	BMW 540I	24
11478	17-23	BMW 540I XDRIVE	24
11479	08-17	MITSUBISHI LANCER	36
11480	07-19	TOYOTA YARIS	24
11482	03-06	INFINITI G35	30
11484	12-17	TOYOTA PRIUS C	24
11485	15-20	MERCEDES-BENZ C300	24
11486	17-22	HYUNDAI IONIQ	24
11487	04-06	SCION XB	32
11488	05-06	SCION XA	38
11490	18-22	TOYOTA C-HR	30
11492	17-19	CHEVROLET CRUZE	24
11493	08-13	INFINITI G37	44
11493	14-14	INFINITI Q60	44

Part #	Years	Make / Model	Pallet Qty
11493	06-06	NISSAN 350Z	44
11496	09-14	ACURA TL	32
11496	09-14	ACURA TSX	32
11496	08-10	HONDA ACCORD	32
11497	05-06	SAAB 9-2X	24
11497	03-07	SUBARU IMPREZA	24
11498	04-07	BMW 525I	24
11498	06-07	BMW 525XI	24
11498	08-10	BMW 528I	24
11498	09-10	BMW 528I XDRIVE	24
11498	08-08	BMW 528XI	24
11498	04-07	BMW 530I	24
11498	06-07	BMW 530XI	24
11498	08-10	BMW 535I	24
11498	10-10	BMW 535I GT	24
11498	09-10	BMW 535I XDRIVE	24
11498	08-08	BMW 535XI	24
11498	04-05	BMW 545I	24
11498	06-10	BMW 550I	24
11498	10-10	BMW 550I GT	24
11498	10-10	BMW 550I GT XDRIVE	24
11499	11-12	INFINITI G25	30
11499	07-08	INFINITI G35	30
11499	09-13	INFINITI G37	30
11509	18-20	HYUNDAI ELANTRA GT	24
11510	08-12	INFINITI EX35	30
11510	13-13	INFINITI EX37	30
11510	14-17	INFINITI QX50	30
11522	17-24	MINI COOPER COUNTRYMAN	24
11523	18-19	TOYOTA PRIUS C	24
11524	16-21	MINI COOPER CLUBMAN	24
11525	18-22	HONDA ACCORD	24
11527	13-22	BUICK ENCORE	32
11527	15-22	CHEVROLET TRAX	32
11529	18-22	HYUNDAI KONA	24
11530	18-23	BMW X2	24
11535	15-20	ACURA TLX	24
11540	19-24	VOLKSWAGEN JETTA	24
11548	18-20	HYUNDAI ACCENT	24
11550	19-21	HYUNDAI VELOSTER	24
11555	07-16	HONDA CR-V	30
11563	18-24	NISSAN KICKS	24
11564	15-19	VOLKSWAGEN GOLF R	24
11567	18-22	TOYOTA C-HR	24
11567	19-25	TOYOTA COROLLA	24
11575	20-25	KIA SOUL	24
11576	19-25	LEXUS ES300H	24
11576	19-25	LEXUS ES350	24
11576	19-22	TOYOTA AVALON	24
11576	18-24	TOYOTA CAMRY	24
11578	21-25	KIA SELTOS	24
11581	17-23	TESLA 3	24
11591	16-25	HONDA CIVIC	24
11596	20-24	TOYOTA COROLLA	24
11599	20-24	MAZDA CX-30	24
11604	16-18	HONDA CIVIC	48
11609	20-24	HYUNDAI VENUE	30
11612	20-25	BUICK ENCORE GX	24
11612	21-25	CHEVROLET TRAILBLAZER	24
11615	19-19	KIA FORTE	24
11619	20-23	HYUNDAI SONATA	20
11620	20-24	KIA FORTE	24
11623	21-24	KIA K5	26
11630	21-24	HYUNDAI ELANTRA	24
11633	19-25	MAZDA 3	28
11636	19-21	MAZDA 3	28
11637	22-24	TOYOTA COROLLA CROSS	28
11638	22-23	HYUNDAI KONA	24
11638	22-23	HYUNDAI KONA N	24
11640	23-25	HONDA HR-V	48
11648	18-25	NISSAN LEAF	30
11663	22-24	SUBARU WRX	16
11665	23-24	HONDA ACCORD	24
11670	21-25	ACURA TLX	24

Part #	Years	Make / Model	Pallet Qty	Part #	Years	Make / Model	Pallet Qty	Part #	Years	Make / Model	Pallet Qty
11675	24-24	SUBARU IMPREZA	24	12022	10-11	BUICK LUCERNE	30	12107	12-17	TOYOTA CAMRY	20
11679	05-09	KIA SPECTRA	28	12027	04-05	CHEVROLET CLASSIC	30	12108	06-18	TOYOTA RAV4	30
11681	13-17	HONDA ACCORD	32	12027	97-03	CHEVROLET MALIBU	30	12110	04-08	TOYOTA SOLARA	36
11683	25-25	TOYOTA CAMRY	16	12027	97-99	OLDSMOBILE CUTLASS	30	12111	13-19	FORD ESCAPE	26
11700	03-11	HONDA ELEMENT	30	12028	00-07	CHEVROLET MONTE CARLO	14	12112	07-15	MAZDA CX-9	24
11701	03-09	MERCEDES-BENZ E320	40	12030	10-15	HYUNDAI TUCSON	28	12113	13-18	HYUNDAI SANTA FE SPORT	26
11701	06-09	MERCEDES-BENZ E350	40	12030	11-15	KIA SPORTAGE	28	12113	14-15	KIA SORENTO	26
11701	03-06	MERCEDES-BENZ E500	40	12031	99-17	HONDA ODYSSEY	52	12114	12-17	LEXUS LS460	24
11701	03-06	MERCEDES-BENZ E55 AMG	40	12035	02-04	CHRYSLER CONCORDE	20	12115	10-16	BUICK LACROSSE	8
11701	07-09	MERCEDES-BENZ E550	40	12035	99-01	CHRYSLER LHS	20	12115	11-17	BUICK REGAL	8
11701	07-09	MERCEDES-BENZ E63 AMG	40	12036	07-14	FORD EDGE	44	12115	13-19	CADILLAC XTS	8
11703	90-96	NISSAN 300ZX	10	12036	07-15	LINCOLN MKX	44	12115	14-20	CHEVROLET IMPALA	8
11704	89-92	FORD PROBE	30	12038	98-08	SUBARU FORESTER	50	12115	13-15	CHEVROLET MALIBU	8
11707	91-96	INFINITI G20	24	12041	77-83	BUICK ESTATE WAGON	30	12115	16-16	CHEVROLET MALIBU LIMITED	8
11712	77-88	PORSCHE 924	48	12041	85-90	BUICK LESABRE	30	12116	14-17	KIA RONDO	28
11712	83-91	PORSCHE 944	48	12041	91-96	BUICK ROADMASTER	30	12118	14-20	KIA CADEZZA	30
11713	91-95	TOYOTA MR2	32	12041	77-96	CHEVROLET CAPRICE	30	12122	08-20	NISSAN ROGUE	24
11714	90-92	VOLKSWAGEN GOLF	52	12041	77-92	OLDSMOBILE CUSTOM CRUISER	30	12122	14-15	NISSAN ROGUE SELECT	24
11716	90-94	VOLKSWAGEN CORRADO	34	12041	83-86	PONTIAC PARISIENNE	30	12123	14-23	FORD TRANSIT CONNECT	28
11721	88-89	MERCEDES-BENZ 190D	35	12044	00-05	BUICK LESABRE	30	12126	05-09	HYUNDAI TUCSON	24
11721	88-93	MERCEDES-BENZ 190E	35	12044	06-09	BUICK LUCERNE	30	12126	05-10	KIA SPORTAGE	24
11727	93-97	INFINITI J30	26	12044	01-03	OLDSMOBILE AURORA	30	12130	87-91	FORD COUNTRY SQUIRE	40
11730	94-98	SAAB 900	40	12044	00-05	PONTIAC BONNEVILLE	30	12130	92-11	FORD CROWN VICTORIA	40
11733	75-79	JAGUAR XJ12	35	12047	09-13	SUBARU FORESTER	46	12130	80-83	LINCOLN MARK VI	40
11733	75-87	JAGUAR XJ6	35	12048	11-24	MITSUBISHI OUTLANDER SPORT	28	12130	81-11	LINCOLN TOWN CAR	40
11733	76-93	JAGUAR XJS	35	12048	11-24	MITSUBISHI RVR	28	12130	87-91	MERCURY COLONY PARK	40
11735	95-97	VOLKSWAGEN PASSAT	20	12049	91-96	BUICK PARK AVENUE	24	12130	80-09	MERCURY GRAND MARQUIS	40
11736	95-97	VOLKSWAGEN PASSAT	40	12049	91-96	OLDSMOBILE 98	24	12130	03-04	MERCURY MARAUDER	40
11746	90-97	MAZDA MIATA	24	12049	97-97	OLDSMOBILE REGENCY	24	12134	09-20	DODGE JOURNEY	56
11749	99-05	MAZDA MIATA	30	12051	08-12	CHEVROLET MALIBU	20	12136	14-19	SUBARU OUTBACK	24
11772	96-99	INFINITI I30	33	12051	07-09	SATURN AURA	20	12137	84-01	JEEP CHEROKEE	24
11772	97-99	NISSAN MAXIMA	33	12053	89-97	FORD THUNDERBIRD	26	12138	15-15	JEEP RENEGADE	26
11773	01-03	ACURA MDX	60	12053	93-98	LINCOLN MARK VIII	26	12140	15-24	FORD EDGE	26
11773	03-03	HONDA PILOT	60	12053	89-97	MERCURY COUGAR	26	12142	15-23	JEEP RENEGADE	26
11801	90-96	INFINITI Q45	24	12057	11-17	JEEP COMPASS	32	12143	15-16	LEXUS NX200T	24
11804	88-91	MAZDA 929	32	12057	11-17	JEEP PATRIOT	32	12143	15-16	LEXUS NX300H	24
11807	81-86	SAAB 900	35	12058	00-05	CADILLAC DEVILLE	28	12148	15-18	AUDI Q3	30
11811	89-98	SAAB 9000	33	12058	06-11	CADILLAC DTS	28	12148	15-18	AUDI Q3 QUATTRO	30
11821	99-08	SAAB 9-5	28	12060	05-12	FORD ESCAPE	24	12154	18-21	MITSUBISHI ECLIPSE CROSS	24
11822	00-04	VOLVO S40	40	12060	05-11	MAZDA TRIBUTE	24	12156	16-23	MAZDA CX-9	24
11822	00-04	VOLVO V40	40	12060	05-11	MERCURY MARINER	24	12157	97-05	BUICK PARK AVENUE	20
11823	06-06	MERCEDES-BENZ S350	24	12064	11-23	CHRYSLER 300	48	12158	17-22	KIA SPORTAGE	24
11823	00-06	MERCEDES-BENZ S430	24	12064	11-23	DODGE CHALLENGER	48	12163	16-18	MERCEDES-BENZ CLA250	24
11823	00-06	MERCEDES-BENZ S500	24	12064	11-15	DODGE CHARGER	48	12164	17-19	FORD FUSION	24
11823	01-06	MERCEDES-BENZ S600	24	12065	04-20	TOYOTA SIENNA	30	12164	17-17	LINCOLN MKZ	24
11830	98-03	MERCEDES-BENZ E320	24	12066	11-18	VOLVO S60	20	12165	17-20	GENESIS G80	24
11900	14-19	CADILLAC CTS	24	12066	15-18	VOLVO V60	20	12165	17-19	GENESIS G90	24
11900	16-24	CHEVROLET CAMARO	24	12066	15-18	VOLVO V60 CROSS COUNTRY	20	12165	12-16	HYUNDAI GENESIS	24
12004	07-09	ACURA RDX	24	12066	08-10	VOLVO V70	20	12169	17-25	HONDA CR-V	24
12005	78-81	BUICK CENTURY	20	12066	09-16	VOLVO XC70	20	12170	13-24	MAZDA CX-5	26
12005	78-87	BUICK REGAL	20	12070	10-16	CADILLAC SRX	22	12171	17-22	KIA NIRO	24
12005	78-87	CHEVROLET EL CAMINO	20	12073	92-98	BUICK SKYLARK	18	12172	17-17	LEXUS NX200T	24
12005	77-88	CHEVROLET MONTE CARLO	20	12073	92-98	OLDSMOBILE ACHIEVA	18	12172	18-21	LEXUS NX300	24
12005	82-83	OLDSMOBILE CUTLASS CIERA	20	12073	92-98	PONTIAC GRAND AM	18	12172	17-21	LEXUS NX300H	24
12005	78-88	OLDS. CUTLASS SUPREME	20	12076	10-13	FORD TRANSIT CONNECT	24	12173	18-20	BUICK REGAL TOURX	24
12005	82-86	PONTIAC BONNEVILLE	20	12083	13-18	ACURA RDX	26	12174	17-24	JEEP COMPASS	24
12005	78-87	PONTIAC GRAND PRIX	20	12086	09-16	HYUNDAI GENESIS	24	12175	18-25	HONDA ODYSSEY	52
12005	78-81	PONTIAC LEMANS	20	12088	09-16	LINCOLN MKS	28	12177	18-24	VOLKSWAGEN TIGUAN	24
12009	71-73	BUICK CENTURION	30	12089	86-97	FORD AEROSTAR	24	12180	17-24	CHRYSLER PACIFICA	24
12009	77-84	BUICK ELECTRA	30	12091	13-20	FORD FUSION	24	12180	20-24	CHRYSLER VOYAGER	24
12009	77-85	BUICK LESABRE	30	12091	13-20	LINCOLN MKZ	24	12181	87-89	DODGE RAIDER	70
12009	92-96	BUICK ROADMASTER	30	12091	13-18	FORD C-MAX	26	12181	89-94	ISUZU AMIGO	70
12009	77-96	CHEVROLET CAPRICE	30	12093	07-12	MAZDA CX-7	24	12181	88-91	ISUZU TROOPER	70
12009	80-84	OLDSMOBILE 98	30	12094	96-07	CHRYSLER TOWN & COUNTRY	40	12181	83-00	MITSUBISHI MONTERO	70
12009	80-80	OLDSMOBILE DELTA 88	30	12094	96-07	DODGE CARAVAN	40	12181	91-97	TOYOTA LAND CRUISER	70
12009	83-86	PONTIAC PARISIENNE	30	12094	96-00	PLYMOUTH VOYAGER	40	12184	18-24	SUBARU CROSSTREK	24
12011	83-04	CHEVROLET S10	24	12095	12-15	CHEVROLET CAPTIVA SPORT	24	12185	18-20	BUICK REGAL SPORTBACK	22
12011	83-90	GMC S15	24	12095	08-10	SATURN VUE	24	12185	16-25	CHEVROLET MALIBU	22
12011	91-04	GMC SONOMA	24	12096	15-19	LINCOLN MKC	8	12188	18-22	FORD ECOSPORT	24
12012	83-11	FORD RANGER	22	12097	09-17	VOLKSWAGEN TIGUAN	72	12189	07-10	CHRYSLER SEBRING	24
12012	94-09	MAZDA B2300	22	12100	14-18	SUBARU FORESTER	32	12189	08-10	DODGE AVENGER	24
12012	94-07	MAZDA B3000	22	12102	99-02	MERCURY VILLAGER	24	12198	19-25	SUBARU FORESTER	24
12012	94-09	MAZDA B4000	22	12102	99-02	NISSAN QUEST	24	12200	19-24	TOYOTA RAV4	24
12013	03-08	TOYOTA MATRIX	24	12107	13-18	TOYOTA AVALON	20	12200	19-24	TOYOTA RAV4 PRIME	24

Part #	Years	Make / Model	Pallet Qty	Part #	Years	Make / Model	Pallet Qty	Part #	Years	Make / Model	Pallet Qty
12201	18-25	CHEVROLET EQUINOX	20	12343	07-11	TOYOTA CAMRY	52	13028	07-07	CHEV. SILV. 3500 CLASSIC	24
12201	18-24	GMC TERRAIN	20	12362	96-07	CHRYSLER TOWN & COUNTRY	24	13028	75-79	FORD F-250	24
12202	21-25	NISSAN ROGUE	24	12362	04-07	DODGE CARAVAN	24	13028	73-97	FORD F-350	24
12203	23-24	MAZDA CX-50	24	12362	96-00	PLYMOUTH VOYAGER	24	13028	88-97	FORD F-SUPER DUTY	24
12211	93-97	VOLVO 850	36	12490	08-15	SCION XB	30	13028	75-78	GMC C15	24
12211	98-02	VOLVO C70	36	13000	10-16	LINCOLN MKT	40	13028	79-86	GMC C1500	24
12211	98-00	VOLVO S70	36	13001	06-13	SUZUKI GRAND VITARA	24	13028	75-78	GMC C25	24
12211	98-00	VOLVO V70	36	13002	10-16	CADILLAC SRX	44	13028	79-00	GMC C2500	24
12217	93-03	VOLKSWAGEN EUROVAN	13	13013	95-04	TOYOTA TACOMA	24	13028	75-78	GMC C35	24
12217	93-94	VOLKSWAGEN TRANSPORTER	13	13014	99-16	FORD F-250 SUPER DUTY	16	13028	79-00	GMC C3500	24
12221	03-10	PONTIAC VIBE	48	13014	99-16	FORD F-350 SUPER DUTY	16	13028	91-02	GMC C3500HD	24
12221	03-13	TOYOTA MATRIX	48	13015	99-03	DODGE RAM 1500 VAN	26	13028	75-78	GMC K15	24
12228	09-10	PONTIAC VIBE	36	13015	99-03	DODGE RAM 2500 VAN	26	13028	79-86	GMC K1500	24
12228	09-13	TOYOTA MATRIX	36	13015	99-03	DODGE RAM 3500 VAN	26	13028	75-78	GMC K25	24
12231	01-06	LEXUS LS430	30	13016	78-95	CHEVROLET G10	22	13028	79-00	GMC K2500	24
12232	86-07	FORD TAURUS	20	13016	78-95	CHEVROLET G20	22	13028	75-78	GMC K35	24
12232	88-94	LINCOLN CONTINENTAL	20	13016	78-96	CHEVROLET G30	22	13028	79-00	GMC K3500	24
12232	86-05	MERCURY SABLE	20	13016	78-78	GMC G15	22	13028	99-99	GMC SIERRA 2500	24
12234	03-08	PONTIAC VIBE	58	13016	79-95	GMC G1500	22	13028	01-06	GMC SIERRA 3500	24
12239	05-09	BUICK ALLURE	24	13016	78-78	GMC G25	22	13028	07-07	GMC SIERRA 3500 CLASSIC	24
12239	97-05	BUICK CENTURY	24	13016	79-95	GMC G2500	22	13029	99-00	CADILLAC ESCALADE	24
12239	05-09	BUICK LACROSSE	24	13016	78-78	GMC G35	22	13029	92-94	CHEVROLET BLAZER	24
12239	98-02	OLDSMOBILE INTRIGUE	24	13016	79-96	GMC G3500	22	13029	92-99	CHEVROLET C1500 SUBURBAN	24
12240	05-10	CHRYSLER 300	64	13017	73-86	CHEVROLET C10 SUBURBAN	20	13029	92-99	CHEVROLET C2500 SUBURBAN	24
12240	08-10	DODGE CHALLENGER	64	13017	73-86	CHEVROLET C20 SUBURBAN	20	13029	92-99	CHEVROLET K1500 SUBURBAN	24
12240	06-10	DODGE CHARGER	64	13017	88-91	CHEVROLET C2500	20	13029	92-99	CHEVROLET K2500 SUBURBAN	24
12240	05-08	DODGE MAGNUM	64	13017	73-86	CHEVROLET K20 SUBURBAN	20	13029	00-00	CHEVROLET SUBURBAN 1500	24
12241	16-21	HYUNDAI TUCSON	32	13017	87-88	CHEVROLET R10 SUBURBAN	20	13029	00-00	CHEVROLET SUBURBAN 2500	24
12242	05-07	FORD FIVE HUNDRED	52	13017	89-91	CHEVROLET R1500 SUBURBAN	20	13029	95-00	CHEVROLET TAHOE	24
12242	05-07	FORD FREESTYLE	52	13017	87-88	CHEVROLET R20 SUBURBAN	20	13029	92-00	GMC YUKON	24
12242	08-09	FORD TAURUS	52	13017	89-91	CHEVROLET R2500 SUBURBAN	20	13033	91-01	FORD EXPLORER	44
12242	08-09	FORD TAURUS X	52	13017	75-78	GMC C15 SUBURBAN	20	13033	01-03	FORD EXPLORER SPORT	44
12242	05-07	MERCURY MONTEGO	52	13017	73-74	GMC C15/C1500 SUBURBAN	20	13033	91-94	MAZDA NAVAJA	44
12242	08-09	MERCURY SABLE	52	13017	79-86	GMC C1500 SUBURBAN	20	13033	97-01	MERCURY MOUNTAINEER	44
12245	08-12	JEEP LIBERTY	22	13017	75-78	GMC C25 SUBURBAN	20	13035	85-05	CHEVROLET ASTRO	13
12252	00-13	CHEVROLET IMPALA	20	13017	73-74	GMC C25/C2500 SUBURBAN	20	13035	85-05	GMC SAFARI	13
12252	14-16	CHEVROLET IMPALA LIMITED	20	13017	79-91	GMC C2500	20	13038	97-04	FORD F-150	16
12253	00-06	LINCOLN LS	24	13017	79-86	GMC C2500 SUBURBAN	20	13038	04-04	FORD F-150 HERITAGE	16
12255	07-10	JEEP COMPASS	48	13017	75-78	GMC K15 SUBURBAN	20	13038	97-99	FORD F-250	16
12255	07-10	JEEP PATRIOT	48	13017	79-86	GMC K1500 SUBURBAN	20	13040	96-14	CHEVROLET EXPRESS 1500	28
12262	04-06	CHRYSLER PACIFICA	20	13017	75-78	GMC K25 SUBURBAN	20	13040	96-24	CHEVROLET EXPRESS 2500	28
12264	08-16	CHRYSLER TOWN & COUNTRY	22	13017	73-74	GMC K25/K2500 SUBURBAN	20	13040	96-24	CHEVROLET EXPRESS 3500	28
12264	08-20	DODGE GRAND CARAVAN	22	13017	79-86	GMC K2500 SUBURBAN	20	13040	96-14	GMC SAVANA 1500	28
12264	12-15	RAM C/V	22	13017	87-91	GMC R1500 SUBURBAN	20	13040	96-24	GMC SAVANA 2500	28
12264	09-14	VOLKSWAGEN ROUTAN	22	13017	87-91	GMC R2500 SUBURBAN	20	13040	96-24	GMC SAVANA 3500	28
12270	90-04	SUBARU LEGACY	32	13018	98-02	MERCEDES-BENZ ML320	80	13041	78-80	DODGE B100	26
12270	00-04	SUBARU OUTBACK	32	13018	03-05	MERCEDES-BENZ ML350	80	13041	81-94	DODGE B150	26
12272	04-07	CHEVROLET MALIBU	26	13018	99-01	MERCEDES-BENZ ML430	80	13041	95-97	DODGE B1500	26
12280	04-07	CHEVROLET MALIBU	34	13018	02-05	MERCEDES-BENZ ML500	80	13041	78-80	DODGE B200	26
12284	05-09	SUBARU LEGACY	30	13019	83-11	FORD RANGER	24	13041	81-94	DODGE B250	26
12284	05-09	SUBARU OUTBACK	30	13019	94-09	MAZDA B2300	24	13041	95-97	DODGE B2500	26
12289	04-07	CHRYSLER TOWN & COUNTRY	32	13019	94-07	MAZDA B3000	24	13041	78-80	DODGE B300	26
12289	04-07	DODGE CARAVAN	32	13019	94-09	MAZDA B4000	24	13041	81-94	DODGE B350	26
12289	04-07	DODGE GRAND CARAVAN	32	13020	95-04	CHEVROLET BLAZER	40	13041	95-97	DODGE B3500	26
12290	15-19	SUBARU LEGACY	26	13020	95-01	GMC JIMMY	40	13042	88-99	CHEVROLET C1500	18
12290	10-13	SUBARU OUTBACK	26	13020	96-04	OLDSMOBILE BRAVADA	40	13042	88-00	CHEVROLET C2500	18
12291	05-17	CHEVROLET EQUINOX	48	13021	83-04	CHEVROLET S10	20	13042	88-00	CHEVROLET C3500	18
12291	10-17	GMC TERRAIN	48	13021	83-90	GMC S15	20	13042	91-00	CHEVROLET C3500HD	18
12291	06-09	PONTIAC TORRENT	48	13021	91-04	GMC SONOMA	20	13042	99-00	CHEVROLET SILVERADO 2500	18
12291	02-07	SATURN VUE	48	13021	96-00	ISUZU HOMBRE	20	13042	88-99	GMC C1500	18
12293	03-06	MITSUBISHI OUTLANDER	24	13024	87-91	TOYOTA 4RUNNER	13	13042	88-00	GMC C2500	18
12296	10-19	FORD TAURUS	52	13028	75-86	CHEVROLET C10	24	13042	88-00	GMC C3500	18
12298	10-14	SUBARU LEGACY	32	13028	75-86	CHEVROLET C20	24	13042	91-00	GMC C3500HD	18
12318	01-09	VOLVO S60	40	13028	88-00	CHEVROLET C2500	24	13042	99-00	GMC SIERRA 2500	18
12318	01-07	VOLVO V70	40	13028	75-86	CHEVROLET C30	24	13043	10-23	LEXUS GX460	90
12318	03-07	VOLVO XC70	40	13028	88-00	CHEVROLET C3500	24	13044	02-07	JEEP LIBERTY	22
12333	05-10	PONTIAC G6	24	13028	91-02	CHEVROLET C3500HD	24	13045	93-98	TOYOTA T100	24
12339	97-03	LEXUS ES300	48	13028	75-86	CHEVROLET K10	24	13046	06-07	SUBARU B9 TRIBECA	35
12339	04-06	LEXUS ES330	48	13028	75-86	CHEVROLET K20	24	13046	08-10	SUBARU TRIBECA	35
12339	95-04	TOYOTA AVALON	48	13028	88-00	CHEVROLET K2500	24	13048	93-98	JEEP GRAND CHEROKEE	24
12339	97-06	TOYOTA CAMRY	48	13028	75-86	CHEVROLET K30	24	13049	97-02	FORD EXPEDITION	22
12339	99-03	TOYOTA SOLARA	48	13028	88-00	CHEVROLET K3500	24	13049	98-02	LINCOLN NAVIGATOR	22
12341	09-15	TOYOTA VENZA	30	13028	99-99	CHEVROLET SILVERADO 2500	24	13050	04-09	CADILLAC SRX	16
12343	07-12	LEXUS ES350	52	13028	01-06	CHEVROLET SILVERADO 3500	24	13051	99-04	JEEP GRAND CHEROKEE	26

Part #	Years	Make / Model	Pallet Qty
13052	08-15	LAND ROVER LR2	24
13053	03-06	FORD E-150	26
13053	75-02	FORD E-150 ECONOLINE	26
13053	03-06	FORD E-250	26
13053	75-02	FORD E-250 ECONOLINE	26
13053	75-98	FORD E-350 ECONOLINE	26
13053	99-06	FORD E-350 SUPER DUTY	26
13055	03-14	FORD E-150	28
13055	00-02	FORD E-150 ECONOLINE	28
13055	03-14	FORD E-250	28
13055	00-02	FORD E-250 ECONOLINE	28
13055	00-14	FORD E-350 SUPER DUTY	28
13056	98-03	DODGE DURANGO	18
13061	11-14	CHEV. SILVERADO 2500 HD	14
13061	11-14	CHEV.SILVERADO 3500 HD	14
13061	11-14	GMC SIERRA 2500 HD	14
13061	11-14	GMC SIERRA 3500 HD	14
13062	11-14	CHEV. SILVERADO 2500 HD	16
13062	11-14	CHEV. SILVERADO 3500 HD	16
13062	11-14	GMC SIERRA 2500 HD	16
13062	11-14	GMC SIERRA 3500 HD	16
13064	98-99	NISSAN FRONTIER	24
13065	11-21	JEEP GRAND CHEROKEE	24
13065	22-22	JEEP GRAND CHEROKEE WK	24
13066	10-15	HYUNDAI TUCSON	48
13066	11-15	KIA SPORTAGE	48
13067	07-14	FORD EDGE	26
13067	07-15	LINCOLN MKX	26
13068	99-17	HONDA ODYSSEY	52
13069	11-14	SUBARU TRIBECA	34
13072	07-09	CHRYSLER ASPEN	70
13072	04-09	DODGE DURANGO	70
13073	10-12	HYUNDAI SANTA FE	56
13073	11-13	KIA SORENTO	56
13076	10-13	FORD TRANSIT CONNECT	24
13077	07-18	BMW X5	26
13077	14-19	BMW X6	26
13078	11-17	NISSAN QUEST	24
13079	11-24	MITSUBISHI OUTLANDER SPORT	26
13079	11-24	MITSUBISHI RVR	26
13081	11-17	JEEP COMPASS	48
13081	11-17	JEEP PATRIOT	48
13082	88-99	CHEVROLET C1500	18
13082	88-00	CHEVROLET C2500	18
13082	88-00	CHEVROLET C3500	18
13082	88-99	CHEVROLET K1500	18
13082	88-00	CHEVROLET K2500	18
13082	88-00	CHEVROLET K3500	18
13082	88-99	GMC C1500	18
13082	88-00	GMC C2500	18
13082	88-00	GMC C3500	18
13082	88-99	GMC K1500	18
13082	88-00	GMC K2500	18
13082	88-00	GMC K3500	18
13083	83-94	CHEVROLET S10 BLAZER	48
13083	92-94	GMC JIMMY	48
13083	83-91	GMC S15 JIMMY	48
13083	91-94	OLDSMOBILE BRAVADA	48
13084	84-01	JEEP CHEROKEE	44
13085	95-03	FORD WINDSTAR	24
13086	84-95	TOYOTA PICKUP	13
13087	96-02	TOYOTA 4RUNNER	24
13088	97-03	INFINITI QX4	24
13088	96-04	NISSAN PATHFINDER	24
13089	96-97	LEXUS LX450	26
13089	91-97	TOYOTA LAND CRUISER	26
13091	92-00	MITSUBISHI MONTERO	48
13092	86-94	NISSAN D21	13
13093	11-23	CHRYSLER 300	52
13093	15-16	DODGE CHALLENGER	52
13093	12-16	DODGE CHARGER	52
13094	92-95	TOYOTA 4RUNNER	13
13095	87-95	NISSAN PATHFINDER	22
13096	94-94	HONDA PASSPORT	30

Part #	Years	Make / Model	Pallet Qty
13096	91-97	ISUZU RODEO	30
13098	96-99	ACURA SLX	20
13098	92-02	ISUZU TROOPER	20
13099	75-86	CHEVROLET C10	13
13099	88-99	CHEVROLET C1500	13
13099	75-86	CHEVROLET C20	13
13099	88-00	CHEVROLET C2500	13
13099	75-86	CHEVROLET C30	13
13099	88-00	CHEVROLET C3500	13
13099	91-00	CHEVROLET C3500HD	13
13099	75-86	CHEVROLET K10	13
13099	88-99	CHEVROLET K1500	13
13099	75-86	CHEVROLET K20	13
13099	88-00	CHEVROLET K2500	13
13099	75-86	CHEVROLET K30	13
13099	88-00	CHEVROLET K3500	13
13099	63-83	FORD F-100	13
13099	75-96	FORD F-150	13
13099	63-96	FORD F-250	13
13099	63-96	FORD F-350	13
13099	88-97	FORD F-SUPER DUTY	13
13099	75-78	GMC C15	13
13099	79-99	GMC C1500	13
13099	75-78	GMC C25	13
13099	79-00	GMC C2500	13
13099	75-78	GMC C35	13
13099	79-00	GMC C3500	13
13099	91-00	GMC C3500HD	13
13099	75-78	GMC K15	13
13099	79-99	GMC K1500	13
13099	75-78	GMC K25	13
13099	79-00	GMC K2500	13
13099	75-78	GMC K35	13
13099	79-00	GMC K3500	13
13102	10-13	MERCEDES-BENZ GL350	20
13102	07-13	MERCEDES-BENZ GL450	20
13102	08-13	MERCEDES-BENZ GL550	20
13102	11-11	MERCEDES-BENZ ML350	20
13103	07-09	MERCEDES-BENZ R320	20
13103	06-12	MERCEDES-BENZ R350	20
13103	06-07	MERCEDES-BENZ R500	20
13105	04-20	TOYOTA SIENNA	26
13106	91-03	FORD EXPLORER	18
13106	97-01	MERCURY MOUNTAINEER	18
13108	01-06	CHEV.SILVERADO 2500 HD	16
13108	07-07	CHEV. SILV. 2500 HD CLASSIC	16
13108	01-06	GMC SIERRA 2500 HD	16
13108	07-07	GMC SIERRA 2500 HD CLASSIC	16
13109	12-21	NISSAN NV1500	22
13109	12-21	NISSAN NV2500	22
13109	12-21	NISSAN NV3500	22
13110	09-20	FORD FLEX	32
13110	10-17	LINCOLN MKT	32
13112	06-10	FORD EXPLORER	24
13112	06-10	MERCURY MOUNTAINEER	24
13113	06-11	MITSUBISHI ENDEAVOR	22
13114	08-13	BMW X6	20
13115	15-21	KIA SEDONA	30
13116	11-18	PORSCHE CAYENNE	26
13116	11-17	VOLKSWAGEN TOUAREG	26
13119	12-16	HONDA CR-V	26
13120	10-15	HYUNDAI TUCSON	30
13120	11-16	KIA SPORTAGE	30
13121	99-00	CADILLAC ESCALADE	26
13121	92-96	CHEVROLET BLAZER	26
13121	92-99	CHEVROLET C1500 SUBURBAN	26
13121	92-99	CHEVROLET C2500 SUBURBAN	26
13121	92-99	CHEVROLET K1500 SUBURBAN	26
13121	92-99	CHEVROLET K2500 SUBURBAN	26
13121	00-00	CHEVROLET SUBURBAN 1500	26
13121	00-00	CHEVROLET SUBURBAN 2500	26
13121	95-00	CHEVROLET TAHOE	26
13121	92-99	GMC C1500 SUBURBAN	26
13121	92-99	GMC C2500 SUBURBAN	26

Part #	Years	Make / Model	Pallet Qty
13121	92-99	GMC K1500 SUBURBAN	26
13121	92-99	GMC K2500 SUBURBAN	26
13121	92-00	GMC YUKON	26
13125	97-02	FORD EXPEDITION	26
13125	98-02	LINCOLN NAVIGATOR	26
13126	14-20	INFINITI QX60	38
13126	13-16	NISSAN PATHFINDER	38
13128	12-19	LAND ROV. RANGE ROV. EVOQUE	28
13130	13-18	ACURA RDX	24
13131	13-19	FORD ESCAPE	24
13132	83-04	CHEVROLET S10	28
13132	83-90	GMC S15	28
13132	91-04	GMC SONOMA	28
13133	09-17	VOLKSWAGEN TIGUAN	210
13135	16-17	SUBARU CROSSTREK	26
13135	13-15	SUBARU XV CROSSTREK	26
13136	09-17	AUDI Q5	25
13136	15-18	PORSCHE MACAN	25
13138	83-11	FORD RANGER	26
13138	94-09	MAZDA B2300	26
13138	94-07	MAZDA B3000	26
13138	94-09	MAZDA B4000	26
13140	13-15	BMW X1	13
13142	10-12	MERCEDES-BENZ GLK350	8
13143	10-15	LEXUS RX350	28
13143	10-15	LEXUS RX450H	28
13144	14-18	SUBARU FORESTER	20
13145	87-04	DODGE DAKOTA	24
13146	14-20	ACURA MDX	22
13146	16-22	HONDA PILOT	22
13147	09-13	SUBARU FORESTER	40
13149	06-18	TOYOTA RAV4	24
13152	13-18	HYUNDAI SANTA FE SPORT	26
13152	14-15	KIA SORENTO	26
13153	13-18	HYUNDAI SANTA FE	26
13153	19-19	HYUNDAI SANTA FE XL	26
13154	10-12	ACURA RDX	30
13155	13-15	MERCEDES-BENZ GLK250	9
13156	97-03	INFINITI QX4	26
13156	96-04	NISSAN PATHFINDER	26
13157	96-02	TOYOTA 4RUNNER	24
13158	10-14	SUBARU LEGACY	24
13160	84-01	JEEP CHEROKEE	24
13161	07-14	CHEVROLET TAHOE	24
13162	00-06	BMW X5	25
13163	14-20	MITSUBISHI OUTLANDER	20
13165	15-18	CHEVROLET CITY EXPRESS	28
13165	13-21	NISSAN NV200	28
13167	14-23	FORD TRANSIT CONNECT	24
13171	14-19	JEEP CHEROKEE	20
13172	14-18	JEEP CHEROKEE	24
13175	14-18	CHEVROLET SILVERADO 1500	20
13175	19-19	CHEVROLET SILVERADO 1500 LD	20
13175	14-18	GMC SIERRA 1500	20
13175	19-19	GMC SIERRA 1500 LIMITED	20
13176	15-22	CHEVROLET COLORADO	24
13176	15-22	GMC CANYON	24
13177	13-15	MERCEDES-BENZ GLK350	6
13178	15-19	CHEV. SILVERADO 2500 HD	20
13178	15-19	CHEV.SILVERADO 3500 HD	20
13178	15-19	GMC SIERRA 2500 HD	20
13178	15-19	GMC SIERRA 3500 HD	20
13180	00-06	TOYOTA TUNDRA	22
13182	11-25	DODGE DURANGO	24
13182	12-21	JEEP GRAND CHEROKEE	24
13182	22-22	JEEP GRAND CHEROKEE WK	24
13183	00-04	NISSAN X TERRA	26
13184	00-06	TOYOTA TUNDRA	20
13186	13-19	FORD ESCAPE	24
13187	15-19	CHEV.SILVERADO 2500 HD	18
13187	15-19	CHEV. SILVERADO 3500 HD	18
13187	15-19	GMC SIERRA 2500 HD	18
13187	15-19	GMC SIERRA 3500 HD	18
13188	04-10	INFINITI QX56	24

Part #	Years	Make / Model	Pallet Qty	Part #	Years	Make / Model	Pallet Qty	Part #	Years	Make / Model	Pallet Qty
13188	05-15	NISSAN ARMADA	24	13220	04-10	PORSCHE CAYENNE	32	13300	95-04	CHEVROLET BLAZER	48
13188	04-04	NISSAN PATHFINDER ARMADA	24	13220	04-10	VOLKSWAGEN TOUAREG	32	13300	95-01	GMC JIMMY	48
13190	14-16	MERCEDES-BENZ GL450	26	13222	98-02	HONDA PASSPORT	26	13300	96-04	OLDSMOBILE BRAVADA	48
13190	14-16	MERCEDES-BENZ GL550	26	13222	02-04	ISUZU AXIOM	26	13301	07-18	CHEVROLET SILVERADO 1500	18
13190	17-19	MERCEDES-BENZ GLS450	26	13222	98-04	ISUZU RODEO	26	13301	19-19	CHEVROLET SILVERADO 1500 LD	18
13190	17-19	MERCEDES-BENZ GLS550	26	13222	01-03	ISUZU RODEO SPORT	26	13301	07-18	GMC SIERRA 1500	18
13193	22-24	FORD E-TRANSIT	30	13223	97-04	MINI COOPER	48	13301	19-19	GMC SIERRA 1500 LIMITED	18
13193	15-24	FORD TRANSIT-150	30	13229	05-10	DODGE DAKOTA	150	13303	16-22	BMW X1	28
13193	15-24	FORD TRANSIT-250	30	13229	06-09	MITSUBISHI RAIDER	150	13304	17-24	NISSAN TITAN	20
13193	15-24	FORD TRANSIT-350	30	13230	05-10	DODGE DAKOTA	20	13305	17-21	VOLVO S90	24
13194	15-19	LINCOLN MKC	8	13233	16-25	VOLVO XC90	20	13309	17-20	NISSAN PATHFINDER	24
13195	19-20	HYUNDAI SANTA FE	20	13234	15-24	FORD EDGE	24	13310	68-74	DODGE D100 PICKUP	26
13195	16-20	KIA SORENTO	20	13235	98-02	HONDA PASSPORT	22	13310	77-93	DODGE D150	26
13197	17-19	INFINITI QX30	22	13235	89-00	ISUZU AMIGO	22	13310	68-74	DODGE D200 PICKUP	26
13197	15-20	MERCEDES-BENZ GLA250	22	13235	98-04	ISUZU RODEO	22	13310	81-93	DODGE D250	26
13197	15-19	MERCEDES-BENZ GLA45 AMG	22	13235	01-03	ISUZU RODEO SPORT	22	13310	68-74	DODGE D300 PICKUP	26
13198	07-21	TOYOTA TUNDRA	24	13236	15-23	CHRYSLER 300	26	13310	81-93	DODGE D350	26
13199	04-15	NISSAN TITAN	22	13236	11-23	DODGE CHALLENGER	26	13310	80-96	FORD BRONCO	26
13200	14-19	TOYOTA HIGHLANDER	30	13236	15-23	DODGE CHARGER	26	13310	73-83	FORD F-100	26
13201	09-20	DODGE JOURNEY	48	13238	15-18	AUDI Q3	28	13310	75-97	FORD F-150	26
13203	15-22	CHEVROLET COLORADO	40	13238	15-18	AUDI Q3 QUATTRO	28	13310	73-97	FORD F-250	26
13203	15-22	GMC CANYON	40	13240	16-21	HYUNDAI TUCSON	40	13310	73-97	FORD F-350	26
13204	08-20	NISSAN ROGUE	26	13241	05-24	NISSAN FRONTIER	24	13314	97-01	HONDA CR-V	20
13204	14-15	NISSAN ROGUE SELECT	26	13241	09-12	SUZUKI EQUATOR	24	13315	13-24	MAZDA CX-5	24
13205	15-24	NISSAN MURANO	26	13243	14-22	LAND ROV. RANGE ROV. SPORT	12	13316	11-17	BMW X3	32
13206	14-19	SUBARU OUTBACK	24	13245	08-12	JEEP LIBERTY	26	13316	15-18	BMW X4	32
13207	14-24	RAM PROMASTER 1500	24	13250	03-06	DODGE SPRINTER 2500	16	13317	16-24	NISSAN TITAN XD	30
13207	14-24	RAM PROMASTER 2500	24	13250	03-06	DODGE SPRINTER 3500	16	13318	02-08	MERCEDES-BENZ G500	20
13207	14-24	RAM PROMASTER 3500	24	13251	05-10	JEEP GRAND CHEROKEE	36	13320	02-02	DODGE RAM 1500	20
13208	01-10	CHEV. SILVERADO 2500 HD	12	13252	04-12	CHEVROLET COLORADO	26	13322	99-13	CHEVROLET SILVERADO 1500	26
13208	07-07	CHEV. SILV. 2500 HD CLASSIC	12	13252	04-12	GMC CANYON	26	13322	07-07	CHEV. SILVERADO 1500 CLASSIC	26
13208	01-06	CHEVROLET SILVERADO 3500	12	13252	06-06	ISUZU I-280	26	13322	01-06	CHEV. SILVERADO 1500 HD	26
13208	07-07	CHEV. SILV. 3500 CLASSIC	12	13252	07-08	ISUZU I-290	26	13322	07-07	CHEV. SILV. 1500 HD CLASSIC	26
13208	08-10	CHEV. SILVERADO 3500 HD	12	13252	06-06	ISUZU I-350	26	13322	99-04	CHEVROLET SILVERADO 2500	26
13208	01-10	GMC SIERRA 2500 HD	12	13252	07-08	ISUZU I-370	26	13322	99-13	GMC SIERRA 1500	26
13208	07-07	GMC SIERRA 2500 HD CLASSIC	12	13264	16-23	TOYOTA TACOMA	36	13322	07-07	GMC SIERRA 1500 CLASSIC	26
13208	01-06	GMC SIERRA 3500	12	13265	03-06	DODGE SPRINTER 2500	18	13322	01-06	GMC SIERRA 1500 HD	26
13208	07-07	GMC SIERRA 3500 CLASSIC	12	13265	03-06	DODGE SPRINTER 3500	18	13322	07-07	GMC SIERRA 1500 HD CLASSIC	26
13208	07-10	GMC SIERRA 3500 HD	12	13266	11-18	VOLVO S60	24	13322	99-04	GMC SIERRA 2500	26
13209	15-16	AUDI Q3	26	13266	15-18	VOLVO V60	24	13323	05-15	TOYOTA TACOMA	24
13210	01-10	CHEV. SILVERADO 2500 HD	18	13266	15-18	VOLVO V60 CROSS COUNTRY	24	13326	02-02	DODGE RAM 1500	40
13210	07-07	CHEV. SILV. 2500 HD CLASSIC	18	13266	08-10	VOLVO V70	24	13328	01-06	ACURA MDX	52
13210	01-06	CHEVROLET SILVERADO 3500	18	13266	09-16	VOLVO XC70	24	13328	03-08	HONDA PILOT	52
13210	07-07	CHEV. SILV. 3500 CLASSIC	18	13268	10-17	VOLVO XC60	22	13329	17-22	KIA NIRO	26
13210	08-10	CHEV. SILVERADO 3500 HD	18	13269	15-23	JEEP RENEGADE	24	13332	99-06	CHEVROLET SILVERADO 1500	22
13210	01-10	GMC SIERRA 2500 HD	18	13270	06-10	HUMMER H3	32	13332	07-07	CHEV. SILVERADO 1500 CLASSIC	22
13210	07-07	GMC SIERRA 2500 HD CLASSIC	18	13271	16-21	FIAT 500X	24	13332	01-06	CHEV. SILVERADO 1500 HD	22
13210	01-06	GMC SIERRA 3500	18	13272	16-19	LEXUS RX350	24	13332	07-07	CHEV. SILV. 1500 HD CLASSIC	22
13210	07-07	GMC SIERRA 3500 CLASSIC	18	13273	18-21	MITSUBISHI ECLIPSE CROSS	24	13332	99-04	CHEVROLET SILVERADO 2500	22
13210	07-10	GMC SIERRA 3500 HD	18	13275	07-09	DODGE SPRINTER 2500	24	13332	99-06	GMC SIERRA 1500	22
13211	01-10	CHEV. SILVERADO 2500 HD	18	13275	07-09	DODGE SPRINTER 3500	24	13332	07-07	GMC SIERRA 1500 CLASSIC	22
13211	07-07	CHEV. SILV. 2500 HD CLASSIC	18	13275	07-16	FREIGHTLINER SPRINTER 3500	24	13332	01-06	GMC SIERRA 1500 HD	22
13211	01-06	CHEVROLET SILVERADO 3500	18	13275	10-11	MERCEDES-BENZ SPRINTER 3500	24	13332	07-07	GMC SIERRA 1500 HD CLASSIC	22
13211	07-07	CHEV. SILV. 3500 CLASSIC	18	13276	16-23	MERCEDES-BENZ METRIS	26	13332	99-04	GMC SIERRA 2500	22
13211	08-10	CHEV. SILVERADO 3500 HD	18	13277	17-25	AUDI Q7	24	13333	03-10	DODGE RAM 1500	85
13211	01-10	GMC SIERRA 2500 HD	18	13280	87-04	DODGE DAKOTA	24	13333	03-10	DODGE RAM 2500	85
13211	07-07	GMC SIERRA 2500 HD CLASSIC	18	13281	17-22	KIA SPORTAGE	32	13333	03-10	DODGE RAM 3500	85
13211	01-06	GMC SIERRA 3500	18	13282	16-20	LEXUS RX450H	24	13333	11-18	RAM 1500	85
13211	07-07	GMC SIERRA 3500 CLASSIC	18	13284	16-23	MAZDA CX-9	24	13333	19-24	RAM 1500 CLASSIC	85
13211	07-10	GMC SIERRA 3500 HD	18	13285	17-25	CADILLAC XT5	24	13333	11-13	RAM 2500	85
13213	01-10	CHEV. SILVERADO 2500 HD	18	13287	12-18	FORD RANGER	24	13333	11-13	RAM 3500	85
13213	07-07	CHEV. SILV. 2500 HD CLASSIC	18	13290	16-20	MERCEDES-BENZ GLC300	24	13334	07-12	DODGE NITRO	22
13213	01-06	CHEVROLET SILVERADO 3500	18	13290	17-20	MERCEDES-BENZ GLC43 AMG	24	13336	05-07	BUICK TERRAZA	20
13213	07-07	CHEV. SILV. 3500 CLASSIC	18	13291	17-25	JAGUAR F-PACE	24	13336	05-09	CHEVROLET UPLANDER	20
13213	08-10	CHEV. SILVERADO 3500 HD	18	13292	16-18	BUICK ENVISION	24	13336	05-09	PONTIAC MONTANA	20
13213	01-10	GMC SIERRA 2500 HD	18	13293	17-23	GMC ACADIA	24	13336	05-07	SATURN RELAY	20
13213	07-07	GMC SIERRA 2500 HD CLASSIC	18	13294	16-18	MERCEDES-BENZ GLE350	24	13337	15-17	LEXUS NX200T	24
13213	01-06	GMC SIERRA 3500	18	13294	17-19	MERCEDES-BENZ GLE43 AMG	24	13337	18-21	LEXUS NX300	24
13213	07-07	GMC SIERRA 3500 CLASSIC	18	13295	14-24	RAM PROMASTER 1500	40	13337	15-21	LEXUS NX300H	24
13213	07-10	GMC SIERRA 3500 HD	18	13295	14-24	RAM PROMASTER 2500	40	13339	99-12	CHEVROLET SILVERADO 1500	16
13215	15-22	RAM PROMASTER CITY	20	13295	14-24	RAM PROMASTER 3500	40	13339	07-07	CHEV. SILVERADO 1500 CLASSIC	16
13217	93-03	VOLKSWAGEN EUROVAN	13	13296	07-09	CHRYSLER ASPEN	28	13339	01-06	CHEV. SILVERADO 1500 HD	16
13217	93-94	VOLKSWAGEN TRANSPORTER	13	13296	07-09	DODGE DURANGO	28	13339	07-07	CHEV. SILV. 1500 HD CLASSIC	16
13220	07-15	AUDI Q7	32	13297	04-06	DODGE DURANGO	24	13339	99-04	CHEVROLET SILVERADO 2500	16

Part #	Years	Make / Model	Pallet Qty
13339	99-12	GMC SIERRA 1500	16
13339	07-07	GMC SIERRA 1500 CLASSIC	16
13339	01-06	GMC SIERRA 1500 HD	16
13339	07-07	GMC SIERRA 1500 HD CLASSIC	16
13339	99-04	GMC SIERRA 2500	16
13340	02-05	KIA SEDONA	28
13342	07-09	MERCEDES-BENZ ML320	24
13342	06-11	MERCEDES-BENZ ML350	24
13342	06-07	MERCEDES-BENZ ML500	24
13342	08-09	MERCEDES-BENZ ML550	24
13343	11-20	TOYOTA SIENNA	44
13344	05-07	BUICK TERRAZA	26
13344	05-09	CHEVROLET UPLANDER	26
13344	97-05	CHEVROLET VENTURE	26
13344	97-04	OLDSMOBILE SILHOUETTE	26
13344	99-09	PONTIAC MONTANA	26
13344	97-99	PONTIAC TRANS SPORT	26
13345	07-10	HYUNDAI ENTOURAGE	48
13345	06-14	KIA SEDONA	48
13349	07-10	KIA SEDONA	24
13352	04-05	FORD F-150	8
13354	07-13	ACURA MDX	24
13355	97-03	FORD F-150	16
13355	04-04	FORD F-150 HERITAGE	16
13355	97-99	FORD F-250	16
13355	99-15	FORD F-250 SUPER DUTY	16
13355	99-15	FORD F-350 SUPER DUTY	16
13355	08-15	FORD F-450 SUPER DUTY	16
13356	09-16	TOYOTA VENZA	24
13357	04-05	FORD F-150	8
13358	07-09	DODGE SPRINTER 2500	18
13358	07-09	DODGE SPRINTER 3500	18
13358	07-21	FREIGHTLINER SPRINTER 2500	18
13358	07-21	FREIGHTLINER SPRINTER 3500	18
13358	10-24	MERCEDES-BENZ SPRINT 2500	18
13358	10-24	MERCEDES-BENZ SPRINT 3500	18
13359	97-03	FORD F-150	16
13359	04-04	FORD F-150 HERITAGE	16
13359	97-99	FORD F-250	16
13359	99-15	FORD F-250 SUPER DUTY	16
13359	99-15	FORD F-350 SUPER DUTY	16
13359	08-15	FORD F-450 SUPER DUTY	16
13360	06-08	FORD F-150	22
13360	06-08	LINCOLN MARK LT	22
13361	02-08	DODGE RAM 1500	12
13361	03-10	DODGE RAM 2500	12
13361	03-10	DODGE RAM 3500	12
13361	11-24	RAM 2500	12
13361	11-24	RAM 3500	12
13362	96-07	CHRYSLER TOWN & COUNTRY	24
13362	00-03	CHRYSLER VOYAGER	24
13362	96-07	DODGE CARAVAN	24
13362	96-07	DODGE GRAND CARAVAN	24
13362	96-00	PLYMOUTH VOYAGER	24
13363	17-25	JEEP COMPASS	24
13364	08-16	CHRYSLER TOWN & COUNTRY	24
13364	08-20	DODGE GRAND CARAVAN	24
13364	12-15	RAM C/V	24
13364	09-14	VOLKSWAGEN ROUTAN	24
13365	06-08	FORD F-150	26
13365	06-08	LINCOLN MARK LT	26
13366	18-20	VOLKSWAGEN ATLAS	24
13367	07-14	TOYOTA FJ CRUISER	26
13368	09-14	FORD F-150	26
13370	18-25	HONDA ODYSSEY	52
13371	09-14	FORD F-150	26
13374	09-10	DODGE RAM 1500	12
13374	11-18	RAM 1500	12
13374	19-24	RAM 1500 CLASSIC	12
13375	07-10	DODGE SPRINTER 3500	12
13375	07-21	FREIGHTLINER SPRINTER 3500	12
13375	10-19	MERCEDES-BENZ SPRINT 3500	12
13377	17-23	NISSAN QASHQAI	24
13377	17-22	NISSAN ROGUE SPORT	24

Part #	Years	Make / Model	Pallet Qty
13379	10-19	FORD TAURUS	24
13381	18-24	VOLKSWAGEN TIGUAN	24
13382	18-24	SUBARU CROSSTREK	24
13383	17-24	CHRYSLER PACIFICA	24
13383	20-24	CHRYSLER VOYAGER	24
13385	06-14	HONDA RIDGELINE	30
13386	11-19	FORD EXPLORER	52
13386	13-19	FORD POLICE INTER. UTILITY	52
13387	18-25	BMW X3	24
13388	07-09	DODGE SPRINTER 2500	20
13388	07-09	DODGE SPRINTER 3500	20
13388	07-21	FREIGHTLINER SPRINTER 2500	20
13388	07-21	FREIGHTLINER SPRINTER 3500	20
13388	19-20	FREIGHTLINER SPRINTER 1500	20
13388	10-24	MERCEDES-BENZ SPRINT 2500	20
13388	10-24	MERCEDES-BENZ SPRINT 3500	20
13388	19-23	MERCEDES-BENZ SPRINT 1500	20
13389	04-07	CHRYSLER TOWN & COUNTRY	34
13389	04-07	DODGE CARAVAN	34
13389	04-07	DODGE GRAND CARAVAN	34
13390	15-19	SUBARU LEGACY	24
13390	10-13	SUBARU OUTBACK	24
13391	18-24	ALFA ROMEO STELVIO	24
13392	07-24	JEEP WRANGLER	40
13393	19-25	CHEVROLET SILVERADO 1500	24
13393	22-22	CHEV. SILVERADO 1500 LTD	24
13393	19-25	GMC SIERRA 1500	24
13393	22-22	GMC SIERRA 1500 LIMITED	24
13394	18-22	LEXUS RX350L	24
13394	14-19	TOYOTA HIGHLANDER	24
13395	19-23	JEEP CHEROKEE	24
13396	15-19	LAND ROVER DISCOVERY SPORT	24
13397	17-25	HONDA CR-V	24
13398	18-22	MINISUBISHI OUTLANDER PHEV	24
13400	19-24	SUBARU ASCENT	24
13401	73-91	CHEVROLET BLAZER	18
13401	75-86	CHEVROLET K5 BLAZER	18
13401	73-91	GMC JIMMY	18
13402	02-02	CADILLAC ESCALADE	44
13402	02-02	CHEVROLET AVALANCHE 1500	44
13402	02-02	CHEVROLET AVALANCHE 2500	44
13402	00-02	CHEVROLET SUBURBAN 1500	44
13402	00-02	CHEVROLET SUBURBAN 2500	44
13402	00-02	CHEVROLET TAHOE	44
13402	00-02	GMC YUKON	44
13405	19-20	BUICK ENVISION	24
13406	13-18	TOYOTA RAV4	20
13407	01-05	FORD EXPLORER SPORT TRAC	48
13408	97-06	JEEP WRANGLER	52
13409	19-25	SUBARU FORESTER	24
13410	10-19	SUBARU OUTBACK	24
13411	16-18	MERCEDES-BENZ GLE350	20
13411	17-19	MERCEDES-BENZ GLE43 AMG	20
13411	12-15	MERCEDES-BENZ ML350	20
13412	78-83	JEEP CJ5	6
13412	78-86	JEEP CJ7	6
13414	06-10	JEEP COMMANDER	50
13415	19-25	CADILLAC XT4	24
13416	19-24	TOYOTA RAV4	24
13416	19-24	TOYOTA RAV4 PRIME	24
13417	19-23	FORD RANGER	24
13418	19-25	CHEVROLET BLAZER	24
13419	19-25	RAM 1500	150
13420	20-24	KIA TELLURIDE	24
13421	19-25	HONDA PASSPORT	24
13422	03-06	CADILLAC ESCALADE	26
13422	03-06	CADILLAC ESCALADE ESV	26
13422	03-06	CADILLAC ESCALADE EXT	26
13422	03-06	CHEVROLET AVALANCHE 1500	26
13422	03-06	CHEVROLET AVALANCHE 2500	26
13422	03-06	CHEVROLET SUBURBAN 1500	26
13422	03-06	CHEVROLET SUBURBAN 2500	26
13422	03-06	CHEVROLET TAHOE	26
13422	03-06	GMC YUKON	26

Part #	Years	Make / Model	Pallet Qty
13423	19-25	ACURA RDX	24
13424	08-17	BUICK ENCLAVE	48
13424	09-17	CHEVROLET TRAVERSE	48
13424	07-16	GMC ACADIA	48
13424	17-17	GMC ACADIA LIMITED	48
13424	07-10	SATURN OUTLOOK	48
13427	20-25	HYUNDAI PALISADE	24
13429	99-03	LEXUS RX300	26
13429	01-03	TOYOTA HIGHLANDER	26
13430	97-06	JEEP WRANGLER	52
13433	18-24	BUICK ENCLAVE	24
13433	18-23	CHEVROLET TRAVERSE	24
13433	24-24	CHEVROLET TRAVERSE LIMITED	24
13434	20-24	JEEP GLADIATOR	150
13435	14-18	SUBARU FORESTER	24
13438	20-24	FORD EXPLORER	20
13438	20-24	LINCOLN AVIATOR	20
13439	18-25	CHEVROLET EQUINOX	24
13439	18-24	GMC TERRAIN	24
13440	01-07	TOYOTA SEQUOIA	24
13442	08-11	TOYOTA SEQUOIA	48
13443	98-07	LEXUS LX470	20
13443	98-07	TOYOTA LAND CRUISER	20
13445	03-09	LEXUS GX470	26
13445	03-09	TOYOTA 4RUNNER	26
13447	20-25	CHEV. SILVERADO 2500 HD	12
13447	20-25	CHEV. SILVERADO 3500 HD	12
13447	20-25	GMC SIERRA 2500 HD	12
13447	20-25	GMC SIERRA 3500 HD	12
13448	19-24	SUBARU ASCENT	24
13449	17-23	TESLA 3	24
13451	19-25	BMW X5	28
13452	15-24	FORD EDGE	24
13452	16-18	LINCOLN MKX	24
13452	19-23	LINCOLN NAUTILUS	24
13453	20-24	TOYOTA HIGHLANDER	24
13454	20-24	FORD ESCAPE	24
13454	20-24	LINCOLN CORSAIR	24
13455	98-04	LAND ROVER DISCOVERY	18
13456	05-09	LAND ROVER LR3	24
13456	10-16	LAND ROVER LR4	24
13456	06-13	LAND ROV. RANGE ROV. SPORT	24
13457	16-19	TOYOTA HILUX	24
13458	20-24	VOLKS. ATLAS CROSS SPORT	20
13459	19-24	SUBARU FORESTER	20
13460	20-24	TOYOTA HIGHLANDER	24
13462	17-22	CHRYSLER PACIFICA	20
13464	21-25	GENESIS GV80	20
13465	05-10	CHRYSLER 300	60
13465	08-10	DODGE CHALLENGER	60
13465	06-10	DODGE CHARGER	60
13465	05-08	DODGE MAGNUM	60
13466	17-24	CHRYSLER PACIFICA	0
13467	18-20	VOLVO XC60	24
13467	18-20	VOLVO XC90	24
13468	21-24	TOYOTA VENZA	24
13469	02-07	BUICK RENDEZVOUS	24
13469	01-05	PONTIAC AZTEK	24
13470	21-24	TOYOTA SIENNA	26
13471	21-25	NISSAN ROGUE	24
13472	22-24	ACURA MDX	20
13472	23-25	HONDA PILOT	20
13474	21-24	FORD BRONCO SPORT	24
13475	15-24	FORD F-150	26
13477	21-22	MERCEDES-BENZ GLC300	28
13478	22-25	KIA CARNIVAL	24
13479	21-22	BUICK ENVISION	24
13480	21-24	FORD MUSTANG MACH-E	24
13481	21-24	VOLKSWAGEN ATLAS	24
13482	20-25	CADILLAC XT6	0
13484	18-25	VOLVO XC60	24
13485	22-25	HYUNDAI TUCSON	24
13485	23-25	KIA SPORTAGE	24
13486	22-25	HYUNDAI SANTA CRUZ	16

Part #	Years	Make / Model	Pallet Qty	Part #	Years	Make / Model	Pallet Qty	Part #	Years	Make / Model	Pallet Qty
13487	22-24	MINI COOPER	28	13548	07-10	JEEP COMPASS	44	13651	05-11	MAZDA TRIBUTE	20
13489	21-24	VOLKSWAGEN ID.4	210	13548	07-10	JEEP PATRIOT	44	13651	05-11	MERCURY MARINER	20
13490	21-24	MERCEDES-BENZ GLA250	24	13550	02-05	FORD EXPLORER	24	13657	87-95	JEEP WRANGLER	40
13491	21-25	JEEP GRAND CHEROKEE L	30	13550	03-05	LINCOLN AVIATOR	24	13707	87-91	FORD COUNTRY SQUIRE	52
13492	23-24	AUDI Q4 E-TRON	0	13550	02-05	MERCURY MOUNTAINEER	24	13707	92-11	FORD CROWN VICTORIA	52
13492	23-24	AUDI Q4 E-TRON SPORTBACK	0	13551	09-20	FORD FLEX	24	13707	80-83	LINCOLN MARK VI	52
13492	21-24	VOLKSWAGEN ID.4	0	13553	23-24	DODGE HORNET	24	13707	81-11	LINCOLN TOWN CAR	52
13493	21-24	FORD BRONCO	90	13554	09-12	INFINITI FX35	20	13707	79-09	MERCURY GRAND MARQUIS	52
13494	20-25	SUBARU LEGACY	26	13554	13-13	INFINITI FX37	20	13707	03-04	MERCURY MARAUDER	52
13494	20-25	SUBARU OUTBACK	26	13554	09-13	INFINITI FX50	20	13800	01-06	MINI MONTERO	20
13495	22-23	CHEVROLET BOLT EUV	24	13554	14-17	INFINITI QX70	20	13831	00-04	NISSAN FRONTIER	26
13496	22-24	VOLKSWAGEN TAOS	24	13555	07-11	HONDA CR-V	30	13841	00-04	NISSAN FRONTIER	26
13498	22-25	LEXUS NX350	24	13558	03-08	INFINITI FX45	28	13842	03-04	NISSAN FRONTIER	20
13498	22-25	LEXUS NX350H	24	13558	03-08	INFINITI FX45	28	13920	82-04	CHEVROLET S10	40
13498	22-25	LEXUS NX450H+	24	13559	03-14	VOLVO XC90	24	13920	82-90	GMC S15	40
13498	22-25	LEXUS NX250	24	13563	04-09	NISSAN QUEST	28	13920	91-04	GMC SONOMA	40
13499	18-24	AUDI Q5	26	13564	20-24	JEEP WRANGLER	36	13932	99-06	CHEVROLET SILVERADO 1500	32
13499	18-24	AUDI SQ5	26	13566	23-24	MINI COOPER S	24	13932	07-07	CHEV. SILV. 1500 CLASSIC	32
13503	20-24	JEEP GLADIATOR	24	13568	24-24	MAZDA CX-90	24	13932	99-06	GMC SIERRA 1500	32
13504	22-24	FORD MAVERICK	24	13568	25-25	MAZDA CX-70	24	13932	07-07	GMC SIERRA 1500 CLASSIC	32
13505	01-06	HYUNDAI SANTA FE	48	13569	04-05	MINI COOPER SE	30	13942	88-99	CHEVROLET C1500	24
13506	01-04	FORD ESCAPE	24	13570	20-25	SUBARU LEGACY	8	13942	88-99	CHEVROLET K1500	24
13506	01-04	MAZDA TRIBUTE	24	13570	20-25	SUBARU OUTBACK	8	13942	88-99	GMC C1500	24
13507	22-24	JEEP GRAND CHEROKEE	28	13571	03-07	NISSAN MURANO	28	13942	88-99	GMC K1500	24
13510	23-24	MAZDA CX-50	28	13572	99-02	MERCURY VILLAGER	26	14000	12-21	NISSAN NV1500	20
13511	98-03	TOYOTA SIENNA	48	13572	99-02	NISSAN QUEST	26	14000	12-21	NISSAN NV2500	20
13512	22-25	INFINITI QX60	24	13573	04-10	BMW X3	44	14000	12-21	NISSAN NV3500	20
13512	22-24	NISSAN PATHFINDER	24	13574	03-11	HONDA ELEMENT	30	14001	75-89	DODGE D100	26
13513	03-09	KIA SORENTO	24	13575	07-15	MAZDA CX-9	26	14001	68-74	DODGE D100 PICKUP	26
13514	05-15	NISSAN XTERRA	26	13577	09-14	NISSAN MURANO	28	14001	77-93	DODGE D150	26
13515	16-22	LEXUS RX350	24	13579	23-24	LEXUS RX350	24	14001	68-74	DODGE D200 PICKUP	26
13515	16-22	LEXUS RX450H	24	13579	23-24	LEXUS RX350H	24	14001	81-93	DODGE D250	26
13517	99-04	CHEVROLET TRACKER	44	13579	23-24	LEXUS RX500H	24	14001	81-93	DODGE D300 PICKUP	26
13517	99-06	SUZUKI GRAND VITARA	44	13580	71-80	INTERNATIONAL SCOUT II	22	14001	81-93	DODGE D350	26
13517	99-04	SUZUKI VITARA	44	13581	07-13	MINI COOPER S	32	14001	94-01	DODGE RAM 1500	26
13517	02-06	SUZUKI XL7	44	13583	19-24	LEXUS UX250H	24	14001	94-02	DODGE RAM 2500	26
13518	07-09	SUZUKI GRAND VITARA	50	13583	25-25	LEXUS UX300H	24	14001	94-02	DODGE RAM 3500	26
13518	07-09	SUZUKI XL7	50	13585	24-25	BUICK ENVISTA	24	14001	78-96	FORD BRONCO	26
13519	24-24	LEXUS TX350	24	13585	24-25	CHEVROLET TRAX	24	14001	73-83	FORD F-100	26
13519	24-24	LEXUS TX500H	24	13587	04-07	FORD FREESTAR	36	14001	75-96	FORD F-150	26
13519	24-24	LEXUS TX550H+	24	13587	04-07	MERCURY MONTEREY	36	14001	73-97	FORD F-250	26
13519	24-24	TOYOTA GRAND HIGHLANDER	24	13588	23-24	NISSAN ARIYA	24	14001	97-97	FORD F-250 HD	26
13520	22-24	HYUNDAI IONIQ 5	20	13589	24-25	CHEVROLET BLAZER EV	24	14001	73-97	FORD F-350	26
13520	25-25	HYUNDAI IONIQ 5 N	20	13590	99-03	DODGE RAM 1500 VAN	20	14002	09-14	FORD F-150	24
13522	21-24	BUICK ENVISION	0	13590	99-03	DODGE RAM 2500 VAN	20	14005	20-25	CHEV. SILVERADO 2500 HD	12
13523	18-25	HONDA ODYSSEY	24	13590	99-03	DODGE RAM 3500 VAN	20	14005	20-25	CHEV. SILVERADO 3500 HD	12
13524	96-05	TOYOTA RAV4	48	13591	05-17	CHEVROLET EQUINOX	48	14005	20-25	GMC SIERRA 2500 HD	12
13525	22-24	JEEP GRAND CHEROKEE	24	13591	10-17	GMC TERRAIN	48	14005	20-25	GMC SIERRA 3500 HD	12
13525	21-25	JEEP GRAND CHEROKEE L	24	13591	06-09	PONTIAC TORRENT	48	14006	14-18	CHEVROLET SILVERADO 1500	18
13526	05-09	HYUNDAI TUCSON	40	13591	02-07	SATURN VUE	48	14006	19-19	CHEVROLET SILVERADO 1500 LD	18
13526	05-10	KIA SPORTAGE	40	13593	07-12	MAZDA CX-7	24	14006	14-18	GMC SIERRA 1500	18
13529	04-08	CHRYSLER PACIFICA	24	13594	12-15	CHEVROLET CAPTIVA SPORT	24	14006	19-19	GMC SIERRA 1500 LIMITED	18
13530	04-06	LEXUS RX330	24	13594	08-10	SATURN VUE	24	14008	01-06	CHEV. SILVERADO 2500 HD	18
13530	07-09	LEXUS RX350	24	13599	23-24	CADILLAC LYRIQ	24	14008	07-07	CHEVROLET SILVERADO 2500 HD CLASSIC	18
13530	06-08	LEXUS RX400H	24	13601	19-24	INFINITI QX50	24	14008	01-06	CHEVROLET SILVERADO 3500	18
13530	04-07	TOYOTA HIGHLANDER	24	13603	22-24	KIA EV6	24	14008	07-07	CHEV. SILV. 3500 CLASSIC	18
13531	22-25	KIA NIRO	24	13607	24-24	FORD RANGER	24	14008	01-06	GMC SIERRA 2500 HD	18
13531	22-24	KIA NIRO EV	24	13609	21-25	HYUNDAI SANTA FE	24	14008	07-07	GMC SIERRA 2500 HD CLASSIC	18
13532	22-25	BMW IX	24	13609	21-25	KIA SORENTO	24	14008	01-06	GMC SIERRA 3500	18
13534	08-13	TOYOTA HIGHLANDER	24	13610	18-23	HYUNDAI KONA	24	14008	07-07	GMC SIERRA 3500 CLASSIC	18
13535	02-06	HONDA CR-V	40	13610	22-23	HYUNDAI KONA N	24	14009	15-19	CHEV. SILVERADO 2500 HD	16
13536	07-09	ACURA RDX	28	13610	19-23	HYUNDAI KONA ELECTRIC	24	14009	15-19	CHEV. SILVERADO 3500 HD	16
13537	95-02	KIA SPORTAGE	24	13611	19-25	VOLVO XC40	24	14009	15-19	GMC SIERRA 2500 HD	16
13538	07-09	HYUNDAI SANTA FE	48	13611	21-25	VOLVO XC40 RECHARGE	24	14009	15-19	GMC SIERRA 3500 HD	16
13540	91-01	FORD EXPLORER	44	13612	11-17	AUDI Q5	16	14009	15-19	GMC SIERRA 3500 HD	16
13540	91-94	MAZDA NAVAJO	44	13612	15-24	PORSCHE MACAN	16	14010	15-19	CHEV. SILVERADO 2500 HD	18
13540	97-01	MERCURY MOUNTAINEER	44	13613	24-24	LINCOLN NAUTILUS	24	14010	15-19	CHEV. SILVERADO 3500 HD	18
13542	05-07	FORD FIVE HUNDRED	60	13614	25-25	BUICK ENCLAVE	24	14010	15-19	GMC SIERRA 2500 HD	18
13542	05-07	FORD FREESTYLE	60	13614	24-24	CHEVROLET TRAVERSE	24	14010	15-19	GMC SIERRA 3500 HD	18
13542	08-09	FORD TAURUS	60	13614	24-24	GMC ACADIA	24	14011	00-05	FORD EXCURSION	16
13542	05-07	MERCURY MONTEGO	60	13650	05-12	FORD ESCAPE	20	14012	15-24	FORD TRANSIT-150	24
13542	08-09	MERCURY SABLE	60	13650	05-11	MAZDA TRIBUTE	20	14012	15-24	FORD TRANSIT-250	24
13545	07-12	HYUNDAI VERACRUZ	44	13650	05-11	MERCURY MARINER	20	14012	15-24	FORD TRANSIT-350	24
13546	23-24	LEXUS RZ450E	24	13651	05-11	FORD ESCAPE	20	14017	15-24	FORD F-150	22

Part #	Years	Make / Model	Pallet Qty
14018	20-25	FORD F-350 SUPER DUTY	16
14019	19-25	CHEVROLET SILVERADO 1500	24
14019	22-22	CHEV. SILVERADO 1500 LTD	24
14019	19-25	GMC SIERRA 1500	24
14019	22-22	GMC SIERRA 1500 LIMITED	24
14020	02-02	DODGE RAM 1500	20
14021	15-24	FORD F-150	24
14022	22-24	TOYOTA TUNDRA	24
14029	99-00	CADILLAC ESCALADE	24
14029	92-94	CHEVROLET BLAZER	24
14029	92-99	CHEVROLET C1500 SUBURBAN	24
14029	92-99	CHEVROLET C2500 SUBURBAN	24
14029	92-99	CHEVROLET K1500 SUBURBAN	24
14029	92-99	CHEVROLET K2500 SUBURBAN	24
14029	95-00	CHEVROLET TAHOE	24
14029	92-00	GMC YUKON	24
14048	99-20	FORD F-350 SUPER DUTY	14
14048	99-25	FORD F-450 SUPER DUTY	14
14048	99-25	FORD F-550 SUPER DUTY	14
14048	00-25	FORD F-650	14
14053	03-06	FORD E-150	26
14053	75-02	FORD E-150 ECONOLINE	26
14053	03-06	FORD E-250	26
14053	75-02	FORD E-250 ECONOLINE	26
14053	75-98	FORD E-350 ECONOLINE	26
14053	99-06	FORD E-350 SUPER DUTY	26
14055	03-14	FORD E-150	24
14055	00-02	FORD E-150 ECONOLINE	24
14055	03-14	FORD E-250	24
14055	00-02	FORD E-250 ECONOLINE	24
14055	00-14	FORD E-350 SUPER DUTY	24
14061	11-14	CHEV. SILVERADO 2500 HD	14
14061	11-14	CHEV. SILVERADO 3500 HD	14
14061	11-14	GMC SIERRA 2500 HD	14
14061	11-14	GMC SIERRA 3500 HD	14
14062	11-14	CHEV. SILVERADO 2500 HD	16
14062	11-14	CHEV. SILVERADO 3500 HD	16
14062	11-14	GMC SIERRA 2500 HD	16
14062	11-14	GMC SIERRA 3500 HD	16
14070	07-10	DODGE RAM 3500	16
14070	08-10	DODGE RAM 4500	16
14070	08-10	DODGE RAM 5500	16
14070	11-24	RAM 3500	16
14070	11-24	RAM 4500	16
14070	11-24	RAM 5500	16
14080	02-02	CADILLAC ESCALADE	48
14080	02-02	CHEVROLET AVALANCHE 1500	48
14080	02-02	CHEVROLET AVALANCHE 2500	48
14080	00-02	CHEVROLET SUBURBAN 1500	48
14080	00-02	CHEVROLET SUBURBAN 2500	48
14080	00-02	CHEVROLET TAHOE	48
14080	00-02	GMC YUKON	48
14081	88-99	CHEVROLET C1500	18
14081	88-00	CHEVROLET C2500	18
14081	88-00	CHEVROLET C3500	18
14081	88-99	CHEVROLET K1500	18
14081	88-00	CHEVROLET K2500	18
14081	88-00	CHEVROLET K3500	18
14081	88-99	GMC C1500	18
14081	88-00	GMC C2500	18
14081	88-00	GMC C3500	18
14081	88-99	GMC K1500	18
14081	88-00	GMC K2500	18
14081	88-00	GMC K3500	18
14082	75-86	CHEVROLET C10	24
14082	75-86	CHEVROLET C20	24
14082	88-00	CHEVROLET C2500	24
14082	75-86	CHEVROLET C30	24
14082	88-00	CHEVROLET C3500	24
14082	91-02	CHEVROLET C3500HD	24
14082	75-86	CHEVROLET K10	24
14082	75-86	CHEVROLET K20	24
14082	88-00	CHEVROLET K2500	24
14082	75-86	CHEVROLET K30	24

Part #	Years	Make / Model	Pallet Qty
14082	88-00	CHEVROLET K3500	24
14082	99-99	CHEVROLET SILVERADO 2500	24
14082	01-06	CHEVROLET SILVERADO 3500	24
14082	07-07	CHEV. SILV. 3500 CLASSIC	24
14082	75-79	FORD F-250	24
14082	75-97	FORD F-350	24
14082	88-97	FORD F-SUPER DUTY	24
14082	75-78	GMC C15	24
14082	79-86	GMC C1500	24
14082	75-78	GMC C25	24
14082	79-00	GMC C2500	24
14082	75-78	GMC C35	24
14082	79-00	GMC C3500	24
14082	91-02	GMC C3500HD	24
14082	75-78	GMC K15	24
14082	79-86	GMC K1500	24
14082	75-78	GMC K25	24
14082	79-00	GMC K2500	24
14082	75-78	GMC K35	24
14082	79-00	GMC K3500	24
14082	99-99	GMC SIERRA 2500	24
14082	01-06	GMC SIERRA 3500	24
14082	07-07	GMC SIERRA 3500 CLASSIC	24
14090	96-14	CHEVROLET EXPRESS 1500	26
14090	96-24	CHEVROLET EXPRESS 2500	26
14090	96-24	CHEVROLET EXPRESS 3500	26
14090	96-14	GMC SAVANA 1500	26
14090	96-24	GMC SAVANA 2500	26
14090	96-24	GMC SAVANA 3500	26
14108	01-06	CHEV. SILVERADO 2500 HD	20
14108	07-07	CHEV. SILV. 2500 HD CLASSIC	20
14108	01-06	GMC SIERRA 2500 HD	20
14108	07-07	GMC SIERRA 2500 HD CLASSIC	20
14211	01-10	CHEV. SILVERADO 2500 HD	14
14211	07-07	CHEV. SILV. 2500 HD CLASSIC	14
14211	01-06	CHEVROLET SILVERADO 3500	14
14211	07-07	CHEV. SILV. 3500 CLASSIC	14
14211	08-10	CHEV. SILVERADO 3500 HD	14
14211	01-10	GMC SIERRA 2500 HD	14
14211	07-07	GMC SIERRA 2500 HD CLASSIC	14
14211	01-06	GMC SIERRA 3500	14
14211	07-07	GMC SIERRA 3500 CLASSIC	14
14211	07-10	GMC SIERRA 3500 HD	14
14250	03-06	DODGE SPRINTER 2500	16
14250	03-06	DODGE SPRINTER 3500	16
14301	07-18	CHEVROLET SILVERADO 1500	18
14301	19-19	CHEVROLET SILVERADO 1500 LD	18
14301	07-18	GMC SIERRA 1500	18
14301	19-19	GMC SIERRA 1500 LIMITED	18
14332	99-06	CHEVROLET SILVERADO 1500	22
14332	07-07	CHEV. SILVERADO 1500 CLASSIC	22
14332	01-06	CHEV. SILVERADO 1500 HD	22
14332	07-07	CHEV. SILV. 1500 HD CLASSIC	22
14332	99-04	CHEVROLET SILVERADO 2500	22
14332	99-06	GMC SIERRA 1500	22
14332	07-07	GMC SIERRA 1500 CLASSIC	22
14332	01-06	GMC SIERRA 1500 HD	22
14332	07-07	GMC SIERRA 1500 HD CLASSIC	22
14332	99-04	GMC SIERRA 2500	22
14355	97-03	FORD F-150	16
14355	04-04	FORD F-150 HERITAGE	16
14355	97-99	FORD F-250	16
14355	99-15	FORD F-250 SUPER DUTY	16
14355	99-16	FORD F-350 SUPER DUTY	16
14355	08-16	FORD F-450 SUPER DUTY	16
14357	04-05	FORD F-150	8
14360	06-08	FORD F-150	24
14360	06-08	LINCOLN MARK LT	24
14361	02-08	DODGE RAM 1500	14
14361	03-10	DODGE RAM 2500	14
14361	03-10	DODGE RAM 3500	14
14361	11-24	RAM 2500	14
14361	11-24	RAM 3500	14
14374	09-10	DODGE RAM 1500	12

Part #	Years	Make / Model	Pallet Qty
14374	11-18	RAM 1500	12
14374	19-24	RAM 1500 CLASSIC	12
15005	19-25	RAM 1500	10
15007	20-25	CHEV. SILVERADO 2500 HD	8
15007	20-25	CHEV. SILVERADO 3500 HD	8
15007	20-25	GMC SIERRA 2500 HD	8
15007	20-25	GMC SIERRA 3500 HD	8
15010	20-25	CHEV. SILVERADO 2500 HD	8
15010	20-25	CHEV. SILVERADO 3500 HD	8
15010	20-25	GMC SIERRA 2500 HD	8
15010	20-25	GMC SIERRA 3500 HD	8
15300	75-89	DODGE D100	14
15300	68-74	DODGE D100 PICKUP	14
15300	77-93	DODGE D150	14
15300	68-74	DODGE D200 PICKUP	14
15300	81-93	DODGE D250	14
15300	68-74	DODGE D300 PICKUP	14
15300	81-93	DODGE D350	14
15300	94-01	DODGE RAM 1500	14
15300	94-02	DODGE RAM 2500	14
15300	94-02	DODGE RAM 3500	14
15300	78-96	FORD BRONCO	14
15300	73-83	FORD F-100	14
15300	75-96	FORD F-150	14
15300	73-97	FORD F-250	14
15300	73-97	FORD F-350	14
15302	01-10	CHEV. SILVERADO 2500 HD	16
15302	07-07	CHEV. SILV. 2500 HD CLASSIC	16
15302	01-10	GMC SIERRA 2500 HD	16
15302	07-07	GMC SIERRA 2500 HD CLASSIC	16
15306	16-24	NISSAN TITAN XD	12
15307	19-25	CHEV. SILVERADO 1500	8
15307	22-22	CHEV. SILVERADO 1500 LTD	8
15307	19-25	GMC SIERRA 1500	8
15307	22-22	GMC SIERRA 1500 LIMITED	8
15312	01-10	CHEV. SILVERADO 2500 HD	14
15312	07-07	CHEV. SILV. 2500 HD CLASSIC	14
15312	01-06	CHEVROLET SILVERADO 3500	14
15312	07-07	CHEV. SILV. 3500 CLASSIC	14
15312	08-10	CHEV. SILV. 3500 HD	14
15312	01-10	GMC SIERRA 2500 HD	14
15312	07-07	GMC SIERRA 2500 HD CLASSIC	14
15312	01-06	GMC SIERRA 3500	14
15312	07-07	GMC SIERRA 3500 CLASSIC	14
15312	07-10	GMC SIERRA 3500 HD	14
15313	01-10	CHEV. SILVERADO 2500 HD	10
15313	07-07	CHEV. SILV. 2500 HD CLASSIC	10
15313	01-06	CHEV. SILVERADO 3500	10
15313	07-07	CHEV. SILV. 3500 CLASSIC	10
15313	08-10	CHEV. SILVERADO 3500 HD	10
15313	01-10	GMC SIERRA 2500 HD	10
15313	07-07	GMC SIERRA 2500 HD CLASSIC	10
15313	01-06	GMC SIERRA 3500	10
15313	07-07	GMC SIERRA 3500 CLASSIC	10
15313	07-10	GMC SIERRA 3500 HD	10
15316	99-03	FORD F-250 SUPER DUTY	13
15316	99-03	FORD F-350 SUPER DUTY	13
15317	88-00	CHEVROLET C2500	13
15317	88-00	CHEVROLET C3500	13
15317	91-00	CHEVROLET C3500HD	13
15317	88-00	CHEVROLET K2500	13
15317	88-00	CHEVROLET K3500	13
15317	88-00	GMC C2500	13
15317	88-00	GMC C3500	13
15317	88-00	GMC K2500	13
15317	88-00	GMC K3500	13
15318	94-02	DODGE RAM 2500	16
15318	94-98	DODGE RAM 3500	16
15319	94-02	DODGE RAM 2500	12
15319	94-02	DODGE RAM 3500	12
15320	96-14	CHEVROLET EXPRESS 1500	20
15320	96-24	CHEVROLET EXPRESS 2500	20
15320	96-24	CHEVROLET EXPRESS 3500	20
15320	96-14	GMC SAVANA 1500	20

Part #	Years	Make / Model	Pallet Qty
15320	96-24	GMC SAVANA 2500	20
15320	96-24	GMC SAVANA 3500	20
15323	99-13	CHEVROLET SILVERADO 1500	10
15323	07-07	CHEV. SILVERADO 1500 CLASSIC	10
15323	01-06	CHEV. SILVERADO 1500 HD	10
15323	07-07	CHEV. SILV. 1500 HD CLASSIC	10
15323	99-04	CHEVROLET SILVERADO 2500	10
15323	99-13	GMC SIERRA 1500	10
15323	07-07	GMC SIERRA 1500 CLASSIC	10
15323	01-06	GMC SIERRA 1500 HD	10
15323	07-07	GMC SIERRA 1500 HD CLASSIC	10
15323	99-04	GMC SIERRA 2500	10
15324	03-06	CADILLAC ESCALADE	20
15324	03-06	CADILLAC ESCALADE ESV	20
15324	03-06	CADILLAC ESCALADE EXT	20
15324	03-06	CHEVROLET AVALANCHE 1500	20
15324	03-06	CHEVROLET AVALANCHE 2500	20
15324	03-06	CHEVROLET SUBURBAN 1500	20
15324	03-06	CHEVROLET SUBURBAN 2500	20
15324	03-06	CHEVROLET TAHOE	20
15324	03-06	GMC YUKON	20
15325	88-99	CHEVROLET C1500	13
15325	88-00	CHEVROLET C2500	13
15325	88-00	CHEVROLET C3500	13
15325	88-99	CHEVROLET K1500	13
15325	88-00	CHEVROLET K2500	13
15325	88-00	CHEVROLET K3500	13
15325	88-99	GMC C1500	13
15325	88-00	GMC C2500	13
15325	88-00	GMC C3500	13
15325	88-99	GMC K1500	13
15325	88-00	GMC K2500	13
15325	88-00	GMC K3500	13
15363	11-12	CHEV. SILVERADO 2500 HD	10
15363	11-12	CHEV. SILVERADO 3500 HD	10
15363	11-12	GMC SIERRA 2500 HD	10
15363	11-12	GMC SIERRA 3500 HD	10
15398	07-21	TOYOTA TUNDRA	6
15400	99-99	CHEVROLET SILVERADO 2500	16
15400	01-06	CHEVROLET SILVERADO 3500	16
15400	07-07	CHEV. SILV. 3500 CLASSIC	16
15400	08-24	CHEV. SILVERADO 3500 HD	16
15400	07-10	DODGE RAM 3500	16
15400	08-10	DODGE RAM 4500	16
15400	08-10	DODGE RAM 5500	16
15400	99-99	GMC SIERRA 2500	16
15400	01-06	GMC SIERRA 3500	16
15400	07-07	GMC SIERRA 3500 CLASSIC	16
15400	07-24	GMC SIERRA 3500 HD	16
15400	11-24	RAM 3500	16
15400	11-24	RAM 4500	16
15400	11-24	RAM 5500	16
15402	20-25	FORD F-350 SUPER DUTY	8
15409	03-08	DODGE RAM 1500	10
15409	03-10	DODGE RAM 2500	10
15409	03-10	DODGE RAM 3500	10
15409	11-13	RAM 2500	10
15409	11-13	RAM 3500	10
15410	99-16	FORD F-250 SUPER DUTY	10
15410	99-16	FORD F-350 SUPER DUTY	10
15410	08-16	FORD F-450 SUPER DUTY	10
15445	99-20	FORD F-350 SUPER DUTY	10
15445	99-25	FORD F-450 SUPER DUTY	10
15445	99-25	FORD F-550 SUPER DUTY	10
15445	00-25	FORD F-650	10
15460	11-19	CHEV. SILVERADO 2500 HD	10
15460	11-19	CHEV. SILVERADO 3500 HD	10
15460	11-19	GMC SIERRA 2500 HD	10
15460	11-19	GMC SIERRA 3500 HD	10
15572	09-10	DODGE RAM 1500	12
15572	11-18	RAM 1500	12
15572	19-24	RAM 1500 CLASSIC	12
15703	01-04	CHEV. SILVERADO 2500	12
15703	01-10	CHEV. SILVERADO 2500 HD	12

Part #	Years	Make / Model	Pallet Qty
15703	07-07	CHEV. SILV. 2500 HD CLASSIC	12
15703	01-06	CHEVROLET SILVERADO 3500	12
15703	07-07	CHEV. SILV. 3500 CLASSIC	12
15703	08-10	CHEV. SILVERADO 3500 HD	12
15703	01-04	GMC SIERRA 2500	12
15703	01-10	GMC SIERRA 2500 HD	12
15703	07-07	GMC SIERRA 2500 HD CLASSIC	12
15703	01-06	GMC SIERRA 3500	12
15703	07-07	GMC SIERRA 3500 CLASSIC	12
15703	07-10	GMC SIERRA 3500 HD	12
15704	03-08	DODGE RAM 1500	10
15704	03-10	DODGE RAM 2500	10
15704	03-10	DODGE RAM 3500	10
15704	11-15	RAM 2500	10
15704	11-15	RAM 3500	10
15800	99-99	CHEVROLET SILVERADO 2500	16
15800	01-06	CHEVROLET SILVERADO 3500	16
15800	07-07	CHEV. SILV. 3500 CLASSIC	16
15800	08-24	CHEV. SILVERADO 3500 HD	16
15800	07-10	DODGE RAM 3500	16
15800	08-10	DODGE RAM 4500	16
15800	08-10	DODGE RAM 5500	16
15800	99-99	GMC SIERRA 2500	16
15800	01-06	GMC SIERRA 3500	16
15800	07-07	GMC SIERRA 3500 CLASSIC	16
15800	07-24	GMC SIERRA 3500 HD	16
15800	11-24	RAM 3500	16
15800	11-24	RAM 4500	16
15800	11-24	RAM 5500	16
15801	16-24	RAM 2500	8
15801	16-24	RAM 3500	8
15802	17-24	FORD F-250 SUPER DUTY	12
15802	17-24	FORD F-350 SUPER DUTY	12
15802	17-24	FORD F-450 SUPER DUTY	12
15803	14-17	RAM 2500	12
15803	14-17	RAM 3500	12
15804	20-25	FORD F-350 SUPER DUTY	8
15809	03-08	DODGE RAM 1500	8
15809	03-10	DODGE RAM 2500	8
15809	03-10	DODGE RAM 3500	8
15809	11-13	RAM 2500	8
15809	11-13	RAM 3500	8
15810	99-16	FORD F-250 SUPER DUTY	10
15810	99-16	FORD F-350 SUPER DUTY	10
15810	08-16	FORD F-450 SUPER DUTY	10
15845	99-20	FORD F-350 SUPER DUTY	10
15845	99-25	FORD F-450 SUPER DUTY	10
15845	99-25	FORD F-550 SUPER DUTY	10
15845	00-25	FORD F-650	10
15860	11-19	CHEV. SILVERADO 2500 HD	12
15860	11-19	CHEV. SILVERADO 3500 HD	12
15860	11-19	GMC SIERRA 2500 HD	12
15860	11-19	GMC SIERRA 3500 HD	12
31008	08-10	FORD F-250 SUPER DUTY	20
31008	08-10	FORD F-350 SUPER DUTY	20
31008	08-10	FORD F-450 SUPER DUTY	20
31008	08-10	FORD F-550 SUPER DUTY	20
31012	07-20	CADILLAC ESCALADE	18
31012	07-13	CADILLAC ESCALADE EXT	18
31012	07-13	CHEVROLET AVALANCHE	18
31012	14-18	CHEVROLET SILVERADO 1500	18
31012	19-19	CHEVROLET SILVERADO 1500 LD	18
31012	07-14	CHEVROLET SUBURBAN 1500	18
31012	07-14	CHEVROLET TAHOE	18
31012	14-18	GMC SIERRA 1500	18
31012	19-19	GMC SIERRA 1500 LIMITED	18
31012	07-14	GMC YUKON	18
31013	01-04	TOYOTA TACOMA	24
31014	99-03	FORD F-250 SUPER DUTY	40
31014	99-03	FORD F-350 SUPER DUTY	40
31015	10-10	DODGE RAM 2500	20
31015	11-18	RAM 2500	20
31016	96-03	CHEVROLET EXPRESS 1500	24
31016	96-03	CHEVROLET EXPRESS 2500	24

Part #	Years	Make / Model	Pallet Qty
31016	96-03	CHEVROLET EXPRESS 3500	24
31016	96-03	GMC SAVANA 1500	24
31016	96-03	GMC SAVANA 2500	24
31016	96-03	GMC SAVANA 3500	24
31017	06-08	DODGE RAM 1500	24
31017	03-09	DODGE RAM 2500	24
31017	03-09	DODGE RAM 3500	24
31018	11-16	FORD F-250 SUPER DUTY	13
31018	11-16	FORD F-350 SUPER DUTY	13
31021	96-04	CHEVROLET BLAZER	24
31021	94-04	CHEVROLET S10	24
31021	94-01	GMC JIMMY	24
31021	94-04	GMC SONOMA	24
31022	03-07	JEEP LIBERTY	24
31023	11-14	CHEV. SILVERADO 2500 HD	26
31023	11-14	CHEV. SILVERADO 3500 HD	26
31023	11-14	GMC SIERRA 2500 HD	26
31023	11-14	GMC SIERRA 3500 HD	26
31026	92-96	FORD F-150	24
31028	97-06	JEEP WRANGLER	22
31033	11-25	DODGE DURANGO	24
31033	11-17	JEEP GRAND CHEROKEE	24
31034	10-11	HYUNDAI SANTA FE	26
31038	99-02	FORD EXPEDITION	24
31038	99-03	FORD F-150	24
31038	04-04	FORD F-150 HERITAGE	24
31038	99-99	FORD F-250	24
31042	92-94	CHEVROLET BLAZER	26
31042	88-99	CHEVROLET C1500	26
31042	88-99	CHEVROLET K1500	26
31042	92-99	CHEVROLET K1500 SUBURBAN	26
31042	88-00	CHEVROLET K2500	26
31042	92-99	CHEVROLET K2500 SUBURBAN	26
31042	88-00	CHEVROLET K3500	26
31042	95-99	CHEVROLET TAHOE	26
31042	88-99	GMC C1500	26
31042	88-99	GMC K1500	26
31042	92-99	GMC K1500 SUBURBAN	26
31042	88-00	GMC K2500	26
31042	92-99	GMC K2500 SUBURBAN	26
31042	88-00	GMC K3500	26
31042	92-99	GMC YUKON	26
31043	92-99	CHEVROLET C1500 SUBURBAN	24
31043	88-00	CHEVROLET C2500	24
31043	92-99	CHEVROLET C2500 SUBURBAN	24
31043	88-00	CHEVROLET C3500	24
31043	92-99	GMC C1500 SUBURBAN	24
31043	88-00	GMC C2500	24
31043	92-99	GMC C2500 SUBURBAN	24
31043	88-00	GMC C3500	24
31047	05-10	JEEP GRAND CHEROKEE	24
31048	02-04	JEEP GRAND CHEROKEE	13
31049	97-98	FORD EXPEDITION	22
31049	97-98	FORD F-150	22
31049	97-98	FORD F-250	22
31051	97-01	FORD EXPLORER	24
31052	11-16	FORD EXPLORER	26
31053	08-14	FORD E-150	24
31053	08-14	FORD E-250	24
31053	08-14	FORD E-350 SUPER DUTY	24
31054	10-21	TOYOTA 4RUNNER	22
31055	04-07	BUICK RAINIER	16
31055	02-09	CHEVROLET TRAILBLAZER	16
31055	02-09	GMC ENVOY	16
31061	09-15	NISSAN TITAN	13
31063	92-11	FORD RANGER	22
31065	10-10	DODGE RAM 3500	28
31065	11-12	RAM 3500	28
31067	13-18	RAM 3500	20
31068	09-17	FORD EXPEDITION	22
31068	09-14	FORD F-150	22
31068	09-17	LINCOLN NAVIGATOR	22
31069	14-18	CHEVROLET SILVERADO 1500	20
31069	19-19	CHEVROLET SILVERADO 1500 LD	20

Part #	Years	Make / Model	Pallet Qty
31069	14-18	GMC SIERRA 1500	20
31069	19-19	GMC SIERRA 1500 LIMITED	20
31071	15-19	CHEV. SILVERADO 2500 HD	26
31071	15-19	CHEV. SILVERADO 3500 HD	26
31071	15-19	GMC SIERRA 2500 HD	26
31071	15-19	GMC SIERRA 3500 HD	26
31073	15-20	CHEVROLET SUBURBAN	24
31073	15-20	CHEVROLET TAHOE	24
31073	15-20	GMC YUKON	24
31073	15-20	GMC YUKON XL	24
31074	15-22	CHEVROLET COLORADO	22
31074	15-22	GMC CANYON	22
31075	16-23	TOYOTA TACOMA	24
31076	14-21	TOYOTA ARUNNER	24
31077	16-21	NISSAN NV1500	24
31077	16-21	NISSAN NV2500	24
31077	16-21	NISSAN NV3500	24
31077	16-17	NISSAN TITAN XD	24
31078	17-24	FORD F-250 SUPER DUTY	24
31078	17-24	FORD F-350 SUPER DUTY	24
31078	17-19	FORD F-450 SUPER DUTY	24
31080	00-04	DODGE DAKOTA	20
31080	00-03	DODGE DURANGO	20
31081	17-20	NISSAN ARMADA	24
31082	17-20	HONDA RIDGELINE	24
31083	18-20	FORD EXPEDITION	24
31083	15-21	FORD F-150	24
31084	84-01	JEEP CHEROKEE	24
31084	86-92	JEEP COMANCHE	24
31084	84-90	JEEP WAGONEER	24
31086	20-24	JEEP GLADIATOR	0
31086	18-24	JEEP WRANGLER	0
31088	19-21	CHEVROLET SILVERADO 1500	24
31088	22-22	CHEV. SILVERADO 1500 LTD	24
31088	19-21	GMC SIERRA 1500	24
31088	22-22	GMC SIERRA 1500 LIMITED	24
31089	19-24	RAM 2500	24
31090	19-25	RAM 1500	20
31091	20-25	CHEV. SILVERADO 2500 HD	24
31091	20-25	CHEV. SILVERADO 3500 HD	24
31091	20-25	GMC SIERRA 2500 HD	24
31091	20-25	GMC SIERRA 3500 HD	24
31108	01-06	CHEV. SILVERADO 1500 HD	24
31108	07-07	CHEV. SILV. 1500 HD CLASSIC	24
31108	99-04	CHEVROLET SILVERADO 2500	24
31108	01-06	CHEV. SILVERADO 2500 HD	24
31108	07-07	CHEV. SILV. 2500 HD CLASSIC	24
31108	01-06	CHEVROLET SILVERADO 3500	24
31108	07-07	CHEV. SILV. 3500 CLASSIC	24
31108	01-06	CHEVROLET SUBURBAN 2500	24
31108	01-06	GMC SIERRA 1500 HD	24
31108	07-07	GMC SIERRA 1500 HD CLASSIC	24
31108	99-04	GMC SIERRA 2500	24
31108	01-06	GMC SIERRA 2500 HD	24
31108	07-07	GMC SIERRA 2500 HD CLASSIC	24
31108	01-06	GMC SIERRA 3500	24
31108	07-07	GMC SIERRA 3500 CLASSIC	24
31108	01-06	GMC YUKON XL 2500	24
31109	07-10	CHEV. SILVERADO 2500 HD	20
31109	08-10	CHEV. SILVERADO 3500 HD	20
31109	07-10	GMC SIERRA 2500 HD	20
31109	07-10	GMC SIERRA 3500 HD	20
31114	00-05	FORD EXCURSION	36
31114	99-07	FORD F-250 SUPER DUTY	36
31114	99-07	FORD F-350 SUPER DUTY	36
31114	99-07	FORD F-450 SUPER DUTY	36
31114	99-07	FORD F-550 SUPER DUTY	36
31180	01-07	TOYOTA SEQUOIA	26
31180	00-06	TOYOTA TUNDRA	26

Part #	Years	Make / Model	Pallet Qty
31198	08-18	TOYOTA LAND CRUISER	48
31198	08-21	TOYOTA SEQUOIA	48
31198	07-21	TOYOTA TUNDRA	48
31199	04-08	NISSAN TITAN	18
31221	04-12	CHEVROLET COLORADO	18
31221	04-12	GMC CANYON	18
31230	08-10	DODGE DAKOTA	12
31230	08-09	NISSAN FRONTIER	12
31241	05-20	NISSAN FRONTIER	22
31241	05-12	NISSAN PATHFINDER	22
31241	09-12	SUZUKI EQUATOR	22
31270	06-10	HUMMER H3	24
31302	00-06	CADILLAC ESCALADE	13
31302	02-06	CHEVROLET AVALANCHE 1500	13
31302	02-06	CHEVROLET AVALANCHE 2500	13
31302	99-06	CHEVROLET SILVERADO 1500	13
31302	07-07	CHEV SILVERADO 1500 CLAS.	13
31302	00-06	CHEVROLET SUBURBAN 1500	13
31302	00-06	CHEVROLET TAHOE	13
31302	99-06	GMC SIERRA 1500	13
31302	07-07	GMC SIERRA 1500 CLASSIC	13
31302	00-06	GMC YUKON	13
31302	00-06	GMC YUKON XL 1500	13
31310	92-97	FORD F-250	20
31310	92-97	FORD F-350	20
31313	05-15	TOYOTA TACOMA	13
31320	02-08	DODGE RAM 1500	20
31322	07-13	CHEVROLET SILVERADO 1500	10
31322	07-13	GMC SIERRA 1500	10
31352	03-06	FORD EXPEDITION	24
31352	04-08	FORD F-150	24
31352	06-08	LINCOLN MARK LT	24
31367	07-13	TOYOTA ARUNNER	20
31367	07-14	TOYOTA FJ CRUISER	20
31374	09-10	DODGE RAM 1500	18
31374	11-18	RAM 1500	18
31374	19-24	RAM 1500 CLASSIC	18
31408	87-06	JEEP WRANGLER	48
31432	07-18	JEEP WRANGLER	60
31433	07-18	JEEP WRANGLER	24
31514	05-15	NISSAN XTERRA	20
31540	02-06	FORD EXPLORER	26
31604	94-01	DODGE RAM 1500	20
31604	94-02	DODGE RAM 2500	20
31604	94-02	DODGE RAM 3500	20
33055	03-07	FORD E-150	24
33055	91-02	FORD E-150 ECONOLINE	24
33055	03-07	FORD E-250	24
33055	91-02	FORD E-250 ECONOLINE	24
33055	91-98	FORD E-350 ECONOLINE	24
33055	99-07	FORD F-350 SUPER DUTY	24
33328	03-08	HONDA PILOT	24
33328	06-14	HONDA RIDGELINE	24
70101	11-13	DODGE DURANGO	40
70101	11-21	JEEP GRAND CHEROKEE	40
70101	22-22	JEEP GRAND CHEROKEE WK	40
70102	07-18	JEEP WRANGLER	12
70103	19-23	JEEP CHEROKEE	40
70104	12-14	HONDA CR-V	9
70105	18-24	JEEP WRANGLER	12
70107	15-20	CHEVROLET COLORADO	9
70107	15-20	GMC CANYON	9
70108	18-22	CHEVROLET EQUINOX	8
70109	10-17	CHEVROLET EQUINOX	9
70109	10-17	GMC TERRAIN	9
70110	07-18	JEEP WRANGLER	12
70111	15-20	CADILLAC ESCALADE	48
70111	15-20	CHEVROLET SUBURBAN	48
70111	15-20	CHEVROLET TAHOE	48

Part #	Years	Make / Model	Pallet Qty
70111	15-20	GMC YUKON	48
70111	15-20	GMC YUKON XL	48
70112	97-06	JEEP WRANGLER	10
70113	16-18	FORD FOCUS	8
70114	16-19	FORD EXPLORER	8
70115	07-11	HONDA CR-V	8
70116	12-20	CHEVROLET SONIC	9
70117	16-20	BUICK ENVISION	8
70118	17-19	GMC ACADIA	12
70119	14-19	FORD FIESTA	16
70120	16-18	CHEVROLET SILVERADO 1500	45
70120	19-19	CHEVROLET SILVERADO 1500 LD	45
70120	16-20	CHEVROLET SUBURBAN	45
70120	16-20	CHEVROLET TAHOE	45
70120	16-18	GMC SIERRA 1500	45
70120	19-19	GMC SIERRA 1500 LIMITED	45
70121	16-18	RAM 1500	40
70121	19-24	RAM 1500 CLASSIC	40
70123	10-16	CADILLAC SRX	9
70124	08-17	BUICK ENCLAVE	8
70124	13-16	GMC ACADIA	8
70124	17-17	GMC ACADIA LIMITED	8
70127	19-23	FORD RANGER	54
70128	05-07	JEEP LIBERTY	20
70129	20-23	JEEP GLADIATOR	12
70130	15-17	FORD EXPEDITION	54
70130	09-23	FORD F-150	54
70130	15-17	LINCOLN NAVIGATOR	54
70131	15-19	CHEV. SILVERADO 2500 HD	45
70131	15-19	CHEV. SILVERADO 3500 HD	45
70131	15-19	GMC SIERRA 2500 HD	45
70131	15-19	GMC SIERRA 3500 HD	45
70132	19-23	JEEP CHEROKEE	64
70133	20-24	FORD F-250 SUPER DUTY	45
70133	20-24	FORD F-350 SUPER DUTY	45
70134	14-18	JEEP CHEROKEE	32
70135	13-19	FORD FLEX	6
70135	13-15	LINCOLN MKS	6
70135	13-19	LINCOLN MKT	6
70136	19-21	CHEVROLET TRAVERSE	64
70137	17-19	FORD F-250 SUPER DUTY	35
70137	17-19	FORD F-350 SUPER DUTY	35
70138	19-22	CHEVROLET BLAZER	10
70139	18-22	FORD EXPEDITION	45
70139	18-22	LINCOLN NAVIGATOR	45
70140	21-21	FORD BRONCO	210
70141	19-25	CHEVROLET SILVERADO 1500	108
70141	22-22	CHEV. SILVERADO 1500 LTD	108
70141	19-25	GMC SIERRA 1500	108
70141	22-22	GMC SIERRA 1500 LIMITED	108
70142	03-10	DODGE RAM 2500	10
70142	03-10	DODGE RAM 3500	10
70142	11-18	RAM 2500	10
70142	11-18	RAM 3500	10
70143	21-24	FORD BRONCO	24
70144	15-22	CHEVROLET COLORADO	24
70144	15-22	GMC CANYON	24
70145	21-24	CHEVROLET SUBURBAN	12
70145	21-24	CHEVROLET TAHOE	12
70145	21-24	GMC YUKON	12
70145	21-24	GMC YUKON XL	12
70146	19-21	CHEVROLET SILVERADO 1500	40
70146	22-22	CHEV. SILVERADO 1500 LTD	40
70146	21-24	CHEVROLET SUBURBAN	40
70146	21-24	CHEVROLET TAHOE	40
70146	21-24	GMC YUKON	40
70146	21-24	GMC YUKON XL	40
70147	21-24	FORD BRONCO	24

ALL PRODUCTS LISTED NUMERICALLY

Part #	Description	MP	IP	Part #	Description	MP	IP	Part #	Description	MP	IP	Part #	Description	MP	IP
16000	LOOP,SAFETY CHAIN,5	1	0	16631	S20 KIT, 16540, 165	1	0	17337	1500LB SHORT SPRING	1	0	18401	ACTIVELINK SHANK 1-	1	0
16040	CROSSWING SP, BASE	1	0	16636	Q20 KIT,16530,16550	1	0	17348	LDWD SPRING BAR W/C	1	0	18402	ACTIVELINK SHANK 2"	1	0
16051	CROSSWING KIT, 1660	1	0	16641	A20 5TH WHEEL R20 R	1	0	17350	BOLT KIT FOR TRUNNI	1	0	18410	ACTIVELINK SE 2-BIK	1	0
16052	S20 KIT, 16520 AND	1	0	16646	Q24 KIT,16545,16570	1	0	17352	WD, 1000LB DEEP DRO	1	0	18411	ACTIVELINK SE 4-BIK	1	0
16053	S20 KIT, 16520 / 16	1	0	16651	S25 KIT, 16580, 165	1	0	17422	WD,TRUNNION,1500 LB	1	0	18412	ACTIVELINK ULTRA 4-	1	0
16055	RAIL MOUNTED GOOSE	1	0	16721	10 IN 5TH WHEEL LUB	40	0	17499	WD, 800LB W/INTEGRA	1	0	18415	ACTIVELINK CARGO CA	1	0
16085	RAIL MOUNTED GOOSE	1	0	16722	LUBE PLATE,5TH WHEEL	50	0	17500	WD,1000LB W/INTEGRA	1	0	18416	ACTIVELINK 2" BALLM	1	0
16090	30K SPYDER GOOSENEC	1	0	16900	SPACER KIT,5TH WHL	1	0	17501	WD 1500LB W/INTEGRA	1	0	18425	CARGO CADDIE	1	0
16100	5TH WHEEL MOUNTING	1	0	16901	SPACER KIT,5TH WHL	1	0	17506	WD REPLACE HEAD	1	0	18500	SEAT DEFENDER, FRON	12	0
16101	INSTALLATION HARDWA	1	0	16902	5TH WHEEL REPL PINS	40	0	17507	WD REPLACE HEAD	1	0	18501	SEAT DEFENDER, FRON	12	0
16103	BOLT KIT,FIFTH WHEEL	1	0	16904	16130 SERVICE KIT,L	1	0	17508	REPLACEMENT INT-WD	1	0	18502	SEAT DEFENDER, FRON	12	0
16104	5TH WHEEL RAIL KIT,	1	0	16906	16140 A20 LEG KIT	1	0	17509	1500LB REPLACEMENT	1	0	18510	SEAT DEFENDER, REAR	12	0
16111	UNIVERSAL RAIL HARD	1	0	16907	5TH WHEEL LEG KIT	1	0	17510	TRAILER MOUNTED WD	1	0	18511	SEAT DEFENDER,REAR,	12	0
16115	E16 16K 5TH WHEEL U	1	0	16908	POWERRIDE 30K REPL	1	0	17512	TRU-TRACK TENSION B	1	0	18512	SEAT DEFENDER,REAR,	12	0
16116	E16 KIT, 16115 AND	1	0	16913	Q24 LEG KIT	1	0	17513	REPLACEMENT L-PINS	100	0	18520	XL SEAT DEFENDER,BE	12	0
16120	A16 5TH WHEEL	1	0	16914	16125-TCA TOP CLIP	1	0	17515	REPLACE BRACKET	1	0	18521	XL SEAT DEFENDER, B	12	0
16121	A16 5TH WHEEL WITH	1	0	16920	16120 - LEG KIT	1	0	17516	REPLACE BRACKET	1	0	18522	XL SEAT DEFENDER,BE	12	0
16130	Q20 FIFTH WHEEL W/	1	0	16963	Q25 LEG KIT	1	0	17520	TRUTRACK TRAILER MO	1	0	18530	UNIV CARGO DEFENDER	12	0
16131	Q20 KIT, 16130 / 16	1	0	16991	E16 WEDGE KIT	1	0	17535	800LB REPLACEMENT S	4	0	19030	2 IN X 2 IN RECEIVE	1	0
16140	A20 5TH WHEEL HITCH	1	0	16992	A-SERIES WEDGE KIT	5	0	17536	1000LB REPLACEMENT	8	0	19031	2 IN X 2 IN BUMPER	1	0
16141	A20 5TH WHEEL WITH	1	0	16994	WEDGE A SERIES NEW	5	0	17537	1500LB REPLACEMENT	8	0	19100	TRAVEL TRAILER BUMP	1	0
16150	RAILS,5TH WHL,W/CNT	1	0	17003	SNAP-UP BRACKET WD	1	0	17550	BOLT KIT FOR INT-WD	18	0	19101	RECEIVER HITCH,BUMP	1	0
16180	A25 5TH WHEEL HITCH	1	0	17005	SNAP-UP BRACKET WD	1	0	17554	BOLT KIT FOR INT-WD	1	0	19102	SLIDER REPL PARTS,	30	0
16181	A25 5TH WHEEL WITH	1	0	17008	WD,HOOK-UP BRKT,SIN	1	0	17600	TRU TRACK 2P WD W/O	1	0	19103	SLIDER REPL PARTS,	30	0
16190	A30 5TH WHEEL HITCH	1	0	17050	600 TW ROUND BAR WD	1	0	17601	TRU TRACK 2P WD W/S	1	0	19104	SLIDER REPL PARTS,	30	0
16191	A30 HITCH HITCH W/	1	0	17051	800 TW ROUND BAR WD	1	0	18007	STRAP,REPLACEMENT,Q	100	50	19105	SLIDER REPL PARTS P	30	0
16200	CARBIDE BLACK 5TH W	1	0	17052	1000 TW ROUND BAR W	1	0	18008	BIKE RACK TOWABLE S	1	0	19106	SLIDER REPL PARTS,	100	0
16204	CARBIDE 5TH WHEEL R	1	0	17057	1400 TW ROUND BAR W	1	0	18013	BIKE RACK,CLAMP-ON	1	0	19107	SLIDER REPL PARTS,	30	0
16205	HD 5TH WHEEL RAILS	1	0	17062	1000 TW ROUND BAR W	1	0	18016	BIKE BEAM	15	0	19201	16017, 16020 REPL R	1	0
16210	X5 ADAPTER PLATE	1	0	17063	1400 TW ROUND BAR W	1	0	18020	2-BIKE RACK - EXTEN	1	0	19202	16017, 16020 REPL H	1	0
16220	X5 ADAPTER PLATE	1	0	17071	600 TW REPLACEMENT	1	0	18021	2-BIKE RACK, DUAL A	1	0	19203	16021,16022 LRG TBO	1	0
16245	Q24 FIFTH WHEEL W/	1	0	17072	800 TW REPLACEMENT	1	0	18030	RACK,2-BIKE,DUAL AR	2	0	19204	16021,16022 SM TBOL	1	0
16246	Q24 KIT,16245 / 162	1	0	17073	1000 TW REPLACE	1	0	18050	STRAP, BIKE RACK	60	0	19205	16021 REPL HANDLES	1	0
16310	X5 B AND W ADAPTER	1	0	17074	1400 TW REPLACE	1	0	18064	RACK,4-BIKE,TAPERED	1	0	19206	16022 REPL HANDLES	1	0
16315	POWERRIDE 30K 5TH W	1	0	17075	WD REPLACE HEAD	1	0	18065	RACK,5-BIKE,TAPERED	2	0	19207	16023 REPL HANDLES	1	0
16320	POWERRIDE 30K 5TH W	1	0	17076	BOLT KIT	1	0	18085	BIKE RACK, 2-BIKE,	1	0	19208	16023 REPL HARDWARE	1	0
16321	POWERRIDE 30K HITCH	1	0	17100	ADJ HITCH BAR 12 IN	1	0	18087	BIKE RACK, 4-BIKE,	1	0	19209	16025 REPL HANDLES	1	0
16505	16115 E5 ADAPTER KI	1	0	17102	ADJ HITCH BAR 14 IN	1	0	18088	ALUMINUM 2-BIKE, TI	1	0	19210	16025 HARDWARE KIT	1	0
16511	S20 KIT, 16515 AND	1	0	17103	ADJ HITCH BAR 16 IN	1	0	18091	FAT TIRE BIKE RACK	1	0	19211	16120 REPL YOKE SUP	1	0
16515	E16 FIFTH WHEEL HEA	1	0	17109	RETAINER PACKAGE	50	0	18100	CARRIER,CARGO,ALUMI	2	0	19212	A-SERIES REPL HANDL	1	0
16516	E16 KIT, 16515 AND	1	0	17111	SPRING BAR CHAIN AN	16	0	18101	CARRIER,CARGO,ATV	1	0	19213	16140 REPL YOKE SUP	1	0
16520	A16 5TH WHEEL HEAD	1	0	17112	LIFT HANDLE	10	0	18109	CARGO CARRIER FOLDI	1	0	19214	16180 REPL YOKE SUP	1	0
16521	A16 5TH WHEEL WITH	1	0	17114	REPLACEMENT 1 IN RI	25	0	18110	CARGO CARRIER,48"X2	1	0	19215	Q-SERIES REPL HANDL	1	0
16530	Q20 FIFTH WHEEL HEA	1	0	17120	ADJ HITCH BAR 12 IN	1	0	18112	ALUMINUM CARGO CAR	1	0	19216	Q-SERIES REPL LOCK	1	0
16531	S20 KIT, 16540 AND	1	0	17121	ADJ HITCH BAR 14 IN	1	0	18113	ALUMINUM CARGO CAR	1	0	19217	R16-24 REPL ROLLER	1	0
16536	Q20 KIT,16530 AND 1	1	0	17122	ADJ HITCH BAR 16 IN	1	0	18115	ROOF RACK,EXPAND	1	0	19218	R16-24 HEAD MOUNTIN	1	0
16540	A20 5TH WHEEL HEAD	1	0	17123	ADJ HITCH BAR 9 IN	1	0	18117	ROOF RACK,EXTENSION	1	0	19219	R16 HANDLE ASSEMBLY	1	0
16541	A20 5TH WHEEL WITH	1	0	17124	ADJ HITCH BAR 11 IN	1	0	18118	ALUMINUM CROSSBARS	1	0	19220	R20 AND R24 HANDLE	1	0
16545	Q24 FIFTH WHEEL HEA	1	0	17125	ADJ HITCH BAR 10 IN	1	0	18123	STEEL ROOF CARGO CA	1	0	19221	16125 SERVICE KIT 3	1	0
16546	Q24 KIT,16545 AND 1	1	0	17131	2.5" FORGED WD SHAN	1	0	18124	ROOF CARGO CARRIER	1	0	19222	16125 SERVICE KIT 9	1	0
16550	R20 ROLLER, FIFTH W	1	0	17132	2.5" FORGED WD SHAN	1	0	18145	CARGO CARRIER,KNOCK	2	0	19223	REPL GREASE ZERK QT	1	0
16551	S25 KIT, 16580 AND	1	0	17133	2" FORGED WD SHANK,	1	0	18150	CARGO CARRIER BASKE	1	0	19224	16125 HANDLE LOCK R	1	0
16560	R16 ROLLER, FIFTH W	1	0	17134	2" FORGED WD SHANK,	1	0	18151	CARGO CARRIER BASKE	1	0	19225	16130 REPL LEG SPAC	1	0
16564	S20 20K FIFTH WHEEL	1	0	17200	SWAY CONTROL KIT	1	0	18152	CARGO CARRIER,60X24	1	0	19226	16115 HEAD PIN KIT	1	0
16570	R24 ROLLER, FIFTH W	1	0	17201	SWAY CONTROL A-FRA	45	0	18153	CARGO CARRIER,60X24	1	0	19227	16115 HEAD SPRING K	1	0
16574	S25 25K FIFTH WHEEL	1	0	17208	(2)OPTIONAL SNAP UP	1	0	18200	CARGO NET,ROOF RACK	12	0	19228	16115 REPL HANDLE A	1	0
16580	A25 5TH WHEEL HEAD	1	0	17302	WEIGHT DISTRIBUTION	1	0	18201	CARGO NET,EXTENDED	12	0	19231	18115 REPL HARDWARE	1	0
16590	A30 5TH WHEEL HEAD	1	0	17303	WD,1000LB LG TBAR R	1	0	18202	CARGO NET	12	0	19232	REPL HARDWARE FOR 1	1	0
16600	CROSSWING, 20K 5TH	1	0	17307	WEIGHT DISTRIBUTION	1	0	18210	CARGO CARRIER BAG 1	1	0	19233	REPL HARDWARE FOR 1	1	0
16602	CROSSWING 20K SINGL	1	0	17308	WD,800LB LG TBAR RE	1	0	18211	CARGO CARRIER BAG 2	1	0	19234	REPL REFLECTORS FOR	1	0
16611	S20 KIT, 16515, 165	1	0	17312	WD ADJUST ROD K	10	0	18218	CARGO NET, NEW ROOF	10	0	19235	REPL HARDWARE FOR 1	1	0
16612	CROSSWING SFT CHAIN	1	0	17314	WD WASHER SERVICE K	50	0	18219	CARGO NET, EXTENDED	10	0	19236	18153 REPL HARDWARE	1	0
16613	CROSSWING SAFETY CH	1	0	17322	WD,TRUNNION,SHORT B	1	0	18220	ROOF RACK BAG 38"	1	0	19238	18085, 18087 SHORT	1	0
16614	CROSSWING SFTY CHAI	1	0	17332	WD,TRUNNION,SHORT B	1	0	18221	ROOF RACK BAG 59"	1	0	19239	18085, 18087 LONG L	1	0
16615	CROSSWING SAFETY CH	1	0	17333	WD,TRUNNION,1500 LB	1	0	18223	CARGO NET, 60" HITC	10	0	19240	18085, 18087 RIGHT	1	0
16616	E16 KIT, 16515, 165	1	0	17334	WD,600LB SHORT TBAR	1	0	18320	ALUM KAYAK RACK	1	0	19241	18085, 18087 LEFT S	1	0
16621	A16 5TH WHEEL R16 R	1	0	17336	WD,1000LB SHORT TBA	1	0	18325	TAILGATE CARGO EXTE	1	0				

MP = MASTER PACK / IP = INNER PACK

Part #	Description	MP	IP	Part #	Description	MP	IP	Part #	Description	MP	IP	Part #	Description	MP	IP
19242	18115 REPL HARDWARE	1	0	21501	5/8 IN HITCH PIN WI	24	6	23198	DUST COVER,BEARING,	50	0	25471	STAMPED 2" X 2.5" 3	4	0
19244	ACTIVELINK VELCRO S	100	0	21502	UNIVERSAL RECEIVER	24	6	23209	3/4" WHEEL BEARING	1	0	25472	STAMPED 2" X 3" 350	4	0
19245	ACTIVELINK CHANNEL	10	0	21504	5/8" GROOVED HITCH	60	0	23210	1" WHEEL BEARING KI	50	0	25474	STAMPED A-FRAME 2-5	2	0
19246	ACTIVELINK FRAME CU	50	0	21505	5/8" GROOVED PIN AN	30	0	23211	1-1/16" WHEEL BEARI	50	0	28000	SAFETY PIN 3/8" W/	150	0
19247	ACTIVELINK ARM CAP	50	0	21506	5/8" GROOVED PIN AN	24	6	23232	DUST COVER,BEARING,	50	0	28001	SAFETY PIN 3/8" W	24	0
19248	ACTIVELINK PIN AND	50	0	21507	5/8" GROOVED PIN AN	40	0	23244	DUST COVER,BEARING,	24	0	28112	JACK,BOLT ON SWIVEL	100	0
19249	ACTIVELINK SHANK HA	25	0	21510	5/8" PIN AND CLIP,	60	0	23255	LOCK,KING PIN,DUMBE	12	0	28113	JACK,BOLT ON SWIVEL	1	0
19250	60671 REPL PIN AND	40	0	21511	5/8" PIN AND CLIP,	30	0	23256	LOCK, FIFTH WHEEL	20	0	28115	JACK,BOLT ON SWIVEL	80	0
19251	60691 REPL PIN AND	40	0	21541	HITCH PIN,CHRM,1/2"	48	6	23501	1/2" DOGBONE LOCK,	48	24	28116	JACK,BOLT ON SWIVEL	1	0
19253	60611, 60619 CENTER	5	0	21551	5/8 IN CHROME SWIVE	24	6	23502	5/8 IN RIGHT ANGLE	48	24	28155	JACK,BOLT,SWIVEL,2	80	0
19254	EZR SAFETY CHN UBOL	3	0	21561	1/2 IN SWIVL HITCH	24	6	23503	ADJUSTABLE LOCK COU	24	24	28156	JACK,BOLT,SWIVEL,2	1	0
19255	EZR/DBLE LCK REPL H	5	0	21578	5/8 IN HITCH PIN AN	80	0	23504	5/8 IN RIGHT ANGLE	48	24	28200	JACK,A FRAME TOP WI	200	0
19256	EZR/DBL LCK REPL CH	15	0	21579	5/8 IN HITCH PIN WI	25	0	23505	LOCK SET, HITCH AND	24	6	28202	JACK,A FRAME TOP WI	200	0
19257	EZR/DBL LCK REPL HA	10	0	21580	5/8" HITCH PIN FOR	60	0	23506	1/2" W/ 5/8" SLEEVE	48	24	28203	JACK,A FRAME TOPWIN	1	0
19258	EZR/DBL LCK REPL LO	6	0	21581	5/8" HITCH PIN SUPE	24	6	23510	5/8 IN PUSH BUTTON	48	24	28204	JACK,A FRAME SIDE W	160	0
19259	EZR/DBL LCK CYLYNDE	144	0	21582	5/8" CD GROOVED PIN	60	0	23515	5/8 IN DOGBONE LOCK	24	24	28250	JACK,A FRAME TOP WI	200	0
19260	DOUBLELOCK SAFETY C	5	0	21583	5/8" CD GROOVED PIN	24	6	23516	5/8 IN DOGBONE LOCK	48	24	28270	FOOT, JACK WITH HAR	60	0
19261	TOWBAR REPL PINS AN	1	0	21600	CLIP FOR HITCH PIN,	200	0	23517	5/8" DOGBONE LOCK,S	48	24	28271	FOOT, JACK WITH HAR	1	0
19262	RAMBLER RUBBER BOO	1	0	21601	CLIP FOR HITCH PIN	30	0	23518	5/8 IN DOGBONE LOCK	24	6	28272	FOOT, JACK 1.7", ZI	36	0
19263	REPL 16MM ANTIRATTL	50	0	21602	HITCH PIN CLIP, 3 P	100	0	23519	5/8 IN DOGBONE LOCK	48	24	28273	FOOT, JACK 1.7", ZI	1	0
19264	18088 WHEEL BASKET	1	0	21728	PROTECTIVE RUBBER C	18	0	23520	7/8IN SPAN COUPLER	48	24	28274	FOOT, JACK 8.5", ZI	10	0
19265	18088 TIRE STRAP RE	10	0	21800	PLASTIC HITCH BALL	50	0	23521	7/8 IN SPAN COUPLER	48	24	28275	FOOT, JACK 8.5", ZI	1	0
19267	18088 REPLACEMENT E	1	0	21801	PLASTIC HITCH BALL	50	0	23522	2-1/2" SPAN COUPLER	48	24	28276	WHEEL, JACK CASTER,	10	0
19268	QUICK MOUNT SHANK H	25	0	21810	BALL COVER,2 5/16"	50	0	23523	3-3/8" SPAN COUPLER	48	24	28277	WHEEL, JACK CASTER,	6	0
19269	POWERRIDE REPL LUBE	1	0	21811	BALL COVER,2 5/16"	50	0	23526	5/8 DOGBONE WITH 7/	24	24	28278	PIN, SAFETY FOR JAC	1	0
19272	REPL QUICK PIN LANY	60	0	22100	2 IN X 2 IN TUBE CO	40	0	23527	5/8 IN DOGBONE LOCK	48	24	28279	PIN, SAFETY FOR JAC	40	0
19273	REPL CROSSWING HAN	15	0	22101	2 IN X 2 IN TUBE CO	20	0	23528	5/8 IN DOGBONE LOCK	48	24	28300	JACK,WELD,TOP WIND,	160	0
19274	REBELLION ANTI-RATT	200	0	22111	2 IN X 2 IN TUBE CO	20	0	23546	COUPLER LOCK, SOLID	50	0	28301	JACK,WELD, TOP WIND,	1	0
19275	CHN MNT TONGUE ANTI	50	0	22170	2 IN X 2 IN TUBE CO	100	0	23556	LOCK SET,KEYED ALIK	1	0	28302	JACK,WELD ON,SIDE W	120	0
19276	REPL 2-POINT SPRING	1	0	22171	2 IN X 2 IN TUBE CO	20	0	23562	SPARE TIRE LOCK PAC	1	0	28304	JACK,WELD, TOP WIND,	130	0
19277	REPL 2-POINT WD HEA	1	0	22178	BEARING PROTECTOR 2	24	0	23580	SS SLEEVE ADAPTER R	1	0	28306	JACK,WELD ON,2000 L	110	0
19278	REPL 2-POINT HARDWA	16	0	22181	2 IN X 2 IN TUBE CO	20	0	23581	HITCH PIN,1/2" PIVO	48	24	28320	JACK,PIPE MNT, TOPWI	130	0
19279	REPL HANDLE KIT CRO	20	0	22198	BEARING PROTECTOR 2	4	0	23582	SS PIVOT LOCK HITCH	48	24	28321	JACK,PIPE MNT,SIDEW	160	0
19280	REPL COUPLER TUBE C	4	0	22232	DUST COVER, BEARING	24	0	23666	CABLE LOCK	12	0	28322	JACK,PIPE MNT, TOP W	160	0
19281	REPL HDWARE SP CW T	25	0	22244	BEARING PROT,2.44"	24	0	25002	WINCH, SGL, 900LB,	12	0	28323	JACK,PIPE MNT, TOPWI	1	0
19282	REPL SKID PAD CROSS	30	0	22271	1 1/4" RECVR TUBE C	800	0	25003	JACK, MARINE, 1K, P	58	0	28324	JACK,PIPE MNT, SIDE	130	0
19283	WEDGE CROSSWIN TUR	1	0	22272	COVER,RCVR TUBE,2"	200	0	25004	JACK, MARINE, 1K, B	72	0	28351	JACK,PIPEMNT, TOPWIN	1	0
19284	REPL RODNUT FOR 12K	10	0	22275	1 1/4" RECVR TUBE C	120	0	25005	JACK, SW, PIPE MOUN	96	0	28354	JACK,PIPE MNT,SIDEW	120	0
19285	REPL ROCKER BALL IN	25	0	22276	COVER,RCVR TUBE,2"	60	0	25006	JACK, TW, PIPE MOUN	120	0	28356	JACK,PIPE MNT, TOPWI	160	0
19286	CROSSWING REPL HAR	25	0	22277	COVER RECVR TUBE, 2	100	0	25007	JACK, TW, A-FRAME,	150	0	28359	JACK, 5000 LB., SQ.	100	0
19287	REPL A-SERIES TORSI	50	0	22278	COVER, RCVR TUBE, 2	96	24	25010	5/16 IN COUPLER SAF	250	0	28512	JACK, HD SQUARE 10K	1	0
19288	WEDGE CROSSWING SID	1	0	22279	CURT 2" RCVR TUBE C	220	0	25011	5/16 IN COUPLER SAF	24	6	28570	JACK,HD SQUARE TOP	90	0
19289	REPL 17200 SPRING C	100	0	22315	ANTI-RATTLE FOR 1 1	50	0	25012	K-8 1/4 IN COUPLER	200	0	28575	JACK,HD SQUARE SIDE	90	0
19290	REPL 1/2 INCH ANTIR	50	0	22320	2-1/2" ANTI RATTLE	12	4	25013	PIN,COUPLER, 25" W/	24	6	28910	PART, JACK MARINE M	1	0
19295	REPL UPPER WELD	1	0	22322	PROFINISHING PACK (1	0	25014	PART, JACK CASTER W	6	0	28911	PART, JACK MNT BARS	50	0
19296	REPL LOWER HEAD ASS	1	0	22323	5/8" ANTI-RATTLE PI	18	0	25015	PART, SW HANDLE	6	0	28912	PART,JACK CASTER WH	25	0
19297	REPL CLIP FOR NEXT	100	0	22325	2" ANTI-RATTLE CLAM	12	4	25034	5/16" SAFETY PIN W/	200	0	28913	PART,JACK FULL MARI	1	0
19298	REPL SNAP UP BRACKE	1	0	22401	TOW HOOK W/HARDWAR	30	0	25035	5/16" SAFETY PIN W/	24	0	28914	PART,JACK GEAR KIT,	1	0
19299	REPL HORN FOR TM-WD	1	0	22411	TOW HOOK W/HARDWAR	30	0	25080	COUPLER SAFETY PIN	300	0	28921	PART,JACK TOP WIND	50	0
19300	REPL HARDWARE FOR T	5	0	22420	TOW HOOK CHROM 100	30	0	25081	COUPLER SAFETY PIN	24	6	28922	PART,JACK BEARING 2	1	0
19301	REPL SPECTRUM KNOB	50	0	22430	TOW HOOK BLACK 1000	30	0	25094	REPAIR KIT, 1.875"	32	0	28923	PART,JACK SIDE WIND	1	0
19302	REPL SPRING CLIP RO	50	0	22750	TUBE COVER 2 IN X 2	40	0	25100	COUPLER, 2 X 3" STR	8	2	28924	PART,JACK GEAR KIT	1	0
19745	ADJUSTABLE TOW BAR	1	0	22751	STEEL TUBE COVER/PK	20	0	25101	COUPLER,2",A-FRAME,	6	0	28925	PART,JACK CAP 2K SI	1	0
19746	REPLACEMENT SAFETY	50	0	22800	CHOCKS,WHEEL,PAIR	4	0	25105	COUPLER, 1.875 X 2.	20	0	28926	PART,JACK BLACK HAN	1	0
19748	BUMPER BRACKET KIT	4	0	22801	HD RUBBER WHEEL CHO	384	0	25128	COUPLER, 1.875 X 2"	20	0	28927	PART,JACK BLACK HAN	1	0
19749	TOW BAR BLACK VINYL	1	0	22802	HD WHEEL CHOCK 2PK	1	0	25131	COUPLER, 1.875 X 3"	8	2	28930	PART,JACK FEMALE PI	1	0
19750	UNIVERSAL TOW BAR	1	0	22803	HD WHEEL CHOCK 1PK	1	0	25135	COUPLER, 2 X 2.5" 3	8	2	28931	PART,JACK MALE PIPE	100	0
20001	WRENCH,BOX END,1.12	20	0	23020	1/2 IN HITCH LOCK 1	24	6	25138	COUPLER, 2 X 3" 350	8	2	28932	PART,JACK MALE PIPE	100	0
20002	MIRROR	10	0	23021	5/8 IN HITCH LOCK 3	24	6	25153	COUPLER, 2 X 2" 350	8	2	28934	PART,JACK 9/16" PIN	50	0
21100	REDUCER BUSHING 1 I	250	0	23022	COUPLER LOCK BRASS	24	6	25194	REPAIR KIT, 2" COUP	32	0	28935	PART,JACK 5/8" PIN	50	0
21101	REDUCER BUSHING 1 I	200	0	23024	1/2" HITCH PIN LOCK	24	24	25200	COUPLER, 2 5/16",A-F	6	0	28937	PART,JACK 2K/5K FUL	50	0
21200	REDUCER BUSHING 1 I	200	0	23025	3 IN HITCH LOCK 300	48	24	25210	COUPLER,2",A-FRAME,	6	0	28938	ANG 4.375 X 1.000 X	50	0
21201	REDUCER BUSHING 1 I	200	0	23079	LOCK,COUPLER,ROLLED	12	0	25217	COUPLER,2",A-FRAME,	1	0	28939	PART,JACK 2" SNAP R	1	0
21300	REDUCER BUSHING 1 3	120	0	23082	CPLER LCK 1-7/8", 2	12	6	25227	COUPLER,2 5/16",A-F	1	0	28940	PART,JACK 1/2" PLUN	1	0
21301	REDUCER BUSHING 1 3	1	0	23083	KEYED ALIKE 23082 A	8	4	25294	REPAIR KIT,2" COUPL	32	0	28941	PKGD, JACK 2" SNAP	100	0
21400	1/2 IN HITCH PIN WI	60	0	23084	DISK LOCK 1-PACK	24	6	25319	COUPLER,2",ADJST,70	1	0	28942	PKGD, JACK MALE PIP	40	0
21401	1/2 IN HITCH PIN WI	24	6	23085	DISK LOCK 3-PACK KE	24	6	25328	COUPLER,2 5/16",AJU	1	0	28943	PKGD, JACK MALE PIP	40	0
21403	1/2" GROOVED HITCH	120	0	23086	KEYED ALIKE LOCK CO	12	0	25329	COUPLER,2 5/16",AJU	1	0	28944	PKGD, JACK 2K/5K HA	20	0
21404	1/2" GROOVED PIN AN	24	6	23090	COUPLER LOCK	6	0	25330	COUPLER,2 5/16" ADJ	6	0	28950	PART,JACK GEAR KIT	1	0
21410	1/2" PIN AND CLIP,	120	0	23175	WHEEL CHOCK LK	1	0	25388	BOLT KIT, ADJUST CP	40	0	28951	PART,JACK FULL 12K	1	0
21411	1/2" PIN AND CLIP,	30	0	23178	DUST COVER,BEARING,	50	0	25389	25388 PACKAGED BOLT	6	0	28952	PART,JACK CAP 12K	1	0
21500	5/8 IN HITCH PIN WI	60	0	23179	TRAILER LOCK	6	1	25470	STAMPED 2" X 2" 350	4	0				

MP = MASTER PACK / IP = INNER PACK

Part #	Description	MP	IP	Part #	Description	MP	IP	Part #	Description	MP	IP	Part #	Description	MP	IP
28953	PART,JACK HANDLE CL	120	0	40050	1 7/8X3/4 X2 1/8 HI	12	0	42203	2 5/16 IN REPLACEME	1	0	45149	PRELOADED SWAY TAB	2	0
28954	PART,JACK 12K BEARI	1	0	40051	1 7/8X1X2 1/8 HITCH	12	0	42225	SWITCH BALL SET 1 I	6	0	45151	4" DROP WELDED BM 5	4	0
28955	PART,JACK 12K PLUNG	1	0	40052	2X3/4X2 1/8 HITCH B	12	0	42280	SWITCH BALL SET 1 I	6	0	45152	2" RISE WELDED BM 5	4	0
28957	PART,JACK INNER PIP	1	0	40053	2 X 1 X 2 1/8 HITCH	12	0	42780	1 7/8 IN REPLACEMENT	1	0	45154	4" DROP WELDED BM 7	2	0
28958	PART,JACK GEAR KIT	1	0	40054	2 5/16X1X2 1/8 HITCH	12	0	42781	1 7/8 IN REPLACEMENT	1	0	45155	2" RISE WELDED BM 7	4	0
28959	PART,JACK FULL 7K H	50	0	40055	2 5/16 X 1-1/4 HITCH	9	0	45000	BALL MOUNT,4"R X 13	1	0	45190	RV TOWING STARTER K	1	0
28960	PART,JACK 7K GEAR H	1	0	40056	2 X 1-1/4 HITCH BAL	9	0	45001	BALL MOUNT,TRIBALL,	2	0	45220	2 IN DROP W/8 1/4 I	1	0
28961	PART,JACK CAP 7K	1	0	40061	1 7/8 X 3/4 X 1 5/8	12	3	45002	BALL MOUNT,DBL BALL	2	0	45230	4 IN DROP W/8 1/4 I	1	0
28962	PART,JACK 7K DROP L	25	0	40062	1 7/8 X 1 X 2 1/8 H	12	3	45003	BALL MOUNT,VER SHAN	1	0	45240	6 IN DROP W/8 1/4 I	1	0
28963	PART,JACK 7K DROP L	50	0	40063	1 7/8X3/4X2 1/8 HIT	12	3	45005	BALL MOUNT,ATV,1.88	4	0	45250	STRAIGHT BALLMOUNT	1	0
28964	PART,JACK FULL 7K B	50	0	40064	2 X 3/4 X 1 3/4 HIT	12	3	45006	ADAPTER,ATV RECEIVE	6	0	45260	2" DROP BALL MOUNT	1	0
28965	PART,JACK 7K BEARIN	1	0	40065	2 X 3/4 X 2 1/8 HIT	12	3	45007	ADAPTER,BALL MNT TO	25	0	45270	4" DROP BALL MOUNT	1	0
29007	2 IN 20 FT NYLON WI	24	0	40066	2 X 1 X 2 1/8 HITCH	12	3	45008	BALL MOUNT,ADJ DUAL	2	0	45280	6" DROP BALL MOUNT	1	0
29423	WINCH, SGL, 900LB	12	0	40067	2 5/16 X 1 X 2 1/8	12	3	45009	BALL MOUNT,ATV,2.00	4	0	45290	2" DROP BALL MOUNT	2	0
29424	WINCH, SGL, 1200LB	8	0	40068	2 5/16X1 1/4X2 5/8	12	3	45010	STRAIGHT BALL MOUNT	1	0	45293	2" DROP LOADED 1-7/	2	0
29427	WINCH, SGL, 1700LB	8	0	40069	BALL,HITCH 2X1.25X2	12	3	45011	BALL MOUNT, PACKAGE	1	0	45295	2" DROP LOADED 2"BA	2	0
29433	WINCH, SGL, 900LB,	12	0	40070	2 X 1 X 2 1/8 HITCH	12	3	45012	STRAIGHT BALL MOUNT	1	0	45296	4" DROP BALL MOUNT	2	0
29435	WINCH, SGL, 1400LB,	8	0	40071	1 7/8 X 3/4 X 3 HIT	12	3	45013	ADAPTER,RECEIVER,VE	1	0	45297	6" DROP BALL MOUNT	2	0
29450	15' WINCH STRAP	30	0	40072	1 7/8 X 1 X 3 HITCH	12	3	45014	BALL MOUNT 5 IN. RI	1	0	45310	BALL MOUNT 2" DROP	1	0
29451	20' WINCH STRAP	30	0	40073	2 X 3/4 X 3 HITCH B	12	3	45015	BALL MOUNT 5 IN. RI	1	0	45311	BALL MOUNT 4" DROP	1	0
29452	23' WINCH STRAP	18	0	40074	2 X 1 X 3 HITCH BAL	12	3	45016	BALL MOUNT 3.25 DRO	1	0	45312	BALL MOUNT 2" DROP	1	0
29460	25' CABLE 3/16"	20	0	40075	2 5/16 X 1 X 3 HITCH	12	3	45017	BALL MOUNT 2 3/4 IN	1	0	45313	BALL MOUNT 4" DROP	1	0
29461	50' CABLE 7/32"	10	0	40076	2 5/16 X 1 1/4 X 3	12	3	45018	BALL MOUNT, 1 1/4"	1	0	45331	BALL MOUNT,FORGED,2	1	0
29470	CABLE KEEPER	30	0	40078	2-5/16 X 1-1/4 X 2-	12	3	45019	BALL MOUNT, 1 1/4"	1	0	45332	BALL MOUNT,FORGED,4	1	0
29480	STRAP BOLT	30	0	40080	1 7/8X3/4X2 1/8 HIT	12	3	45020	STRAIGHT BALLMOUNT	1	0	45336	BALL MOUNT, 10000 L	1	0
29490	HANDLE, 10", 2-SPD	30	0	40081	1 7/8X1X2 1/8 HITCH	12	3	45021	BALL MOUNT,3 1/8 R,	1	0	45338	BALL MOUNT, 10000 L	1	0
29491	HANDLE, 10", 2-SPD	30	0	40082	2X3/4X2 1/8 HITCH B	12	3	45022	BALL MOUNT,3 3/4D,2	1	0	45340	FORGED BALL MOUNT 1	3	0
29493	HANDLE, 7" BRAKE	30	0	40083	2X1X2 1/8 HITCH BAL	12	3	45023	BALL MOUNT, 4" R, 2	1	0	45341	FORGED BALL MOUNT 1	4	0
29520	WINCH, 2-SPD, 2000L	4	0	40084	2 5/16X1X2 1/8 HITCH	12	3	45024	BALL MOUNT, 5" R, 2	1	0	45342	FORGED BALL MOUNT 1	3	0
29526	WINCH, 2-SPD, 2600L	4	0	40085	2-5/16 X 1-1/4 X 2-	6	0	45025	BALL MOUNT, 5" R, 2	1	0	45360	2" DROP BALLMOUNT	2	0
29532	WINCH, 2-SPD, 3200L	4	0	40086	2-5/16 X 1"RISE X1-	6	0	45026	BALL MOUNT, 3.25"	1	0	45361	4" DROP BALLMOUNT	2	0
29538	WINCH, 2-SPD, 3800L	4	0	40087	2 5/16 X 1 1/4 RAW	6	0	45027	BALL MOUNT, 3.25" D	1	0	45362	6" DROP BALLMOUNT	2	0
29610	WINCH, BRAKE, 1000L	8	0	40088	2 5/16 X 2 X 3 1/2	6	0	45028	BALL MOUNT 6 IN DRO	1	0	45363	6" ADJUSTABLE BALLM	1	0
29615	WINCH, BRAKE, 1500L	4	0	40089	3 X 2 X 3 1/4 HITCH	6	0	45029	BALL MOUNT,KIT 4500	4	0	45364	4" ADJUSTABLE BALLM	1	0
29625	WINCH, BRAKE, 2500L	4	0	40090	2 X 1 1/4 X 2 5/8 H	12	0	45030	2" DROP BALL MOUNT	1	0	45365	8" ADJUSTABLE BALLM	1	0
31001	STEP PAD	4	0	40093	SWAY CONTROL HITCH	50	0	45032	2" DROP BALL MOUNT	1	0	45366	10" ADJUSTABLE BALL	1	0
31002	LICENSE PLATE HOLDE	4	0	40094	2 5/16 GOOSE NECK W	12	0	45033	D-3 W/ PIN, CLIP AN	1	0	45367	SS ANTI-RATTLE CLAM	18	6
31006	SPARE TIRE MOUNT	1	0	40095	1-7/8" ATV BALL, BU	12	0	45034	2" DROP LOADED 1-7/	1	0	45370	FORGED BM 2.5" REC, 6	1	0
31007	SKID SHIELD	8	0	40096	1-7/8" ATV BALL, PA	12	3	45036	2" DROP LOADED 2" B	1	0	45371	FORGED BM 2.5" REC	1	0
31010	WINCH MOUNT	1	0	40097	2" ATV BALL, BULK	12	0	45037	2" DROP LOADED 2" B	3	0	45372	FORGED BM 2.5" REC	1	0
32001	RECEIVER GRIP STEP	1	0	40098	2" ATV BALL, PACKAG	12	3	45038	BALL MOUNT,KIT 4500	4	0	45373	FORGED BM 2.5" REC	1	0
32002	RECEIVR GRIP STEP K	1	0	40099	50MM HITCH BALL, BU	12	0	45040	2" DROP BALL MOUNT	1	0	45374	FORGED BM 2.5" REC	1	0
40001	1 7/8 X 3/4 X 1 5/8	12	0	40103	PKG 3/4 IN REPLACEMENT	100	0	45041	2" DROP LOADED 2-5/	2	0	45375	FORGED BM 3" REC 4"	1	0
40002	1 7/8 X 1 X 2 1/8 H	12	0	40104	PKG 1 IN REPLACEMENT	8	0	45042	4" DROP LOADED 2-5/	2	0	45376	FORGED BM 3" REC 6"	1	0
40003	2 X 3/4 X 1 3/4 HIT	12	0	40105	PKG 1 1/4 IN REPLACEMENT	8	0	45048	RECEIVER EXTENSION	1	0	45377	FORGED BM 3" REC 8"	1	0
40004	2 X 1 X 2 1/8 HITCH	12	0	40161	1 7/8 X 3/4 X 1 5/8	12	3	45049	DUAL BALL AND CLEVI	1	0	45405	BALL MOUNT REDUCER	6	0
40005	2 5/16 X 1 X 2 1/8	12	0	40162	1 7/8 X 1 X 2 1/8 H	12	3	45050	4" DROP BALL MOUNT	1	0	45408	REDUCER SLEEVE SET	9	0
40006	2 5/16X1 1/4X2 5/8	6	0	40164	2 X 3/4 X 1 3/4 HIT	12	3	45051	PKG 4 IN X 2 IN X 8	1	0	45409	REDUCER SLEEVE 3" T	6	0
40007	2-5/16 X 1 X 2-1/4	12	0	40166	2 X 1 X 2 1/8 HITCH	12	3	45052	4" DROP BALL MOUNT	1	0	45430	FORGED BALL MOUNT 2	1	0
40008	BALL,HITCH,2.31X1.2	12	0	40167	2 5/16 X 1 X 2 1/8	12	3	45055	4" DROP LOADED 1-7/	1	0	45431	FORGED BALL MOUNT 2	1	0
40009	2.31X1.25,2.75,20K	12	3	40168	2 5/16X1 1/4X2 5/8	12	0	45056	4" DROP LOADED 2" B	1	0	45432	FORGED BALL MOUNT 2	1	0
40010	PACKAGED 40093 SWAY	24	6	40170	2X1X2 1/8 HITCH BAL	12	3	45057	4" DROP LOADED 2" B	3	0	45446	BALL MOUNT, 12000 L	1	0
40015	1 7/8 X 3/4 X 2 1/8	12	0	40178	2-5/16"X1-1/4"X2-5/	12	3	45059	SHANK,ADJ BALL AND	1	0	45448	BALL MOUNT, 12000 L	1	0
40016	1 7/8 X 3/4 X 3 HIT	12	0	40190	2 X 1 1/4 X 2 5/8 H	12	3	45060	4" DROP BALL MOUNT	1	0	45456	FORGED BALL MOUNT 2	3	0
40017	1 7/8 X 1 X 3 HITCH	12	0	40246	2" ROCKER BALL 3.5K	6	3	45064	6" DROP LOADED 2" B	2	0	45458	FORGED BALL MOUNT 2	4	0
40018	2 X 3/4 X 2 1/8 HIT	12	0	40247	2" ROCKER BALL 7.5K	6	3	45065	6" DROP LOADED 2-5/	2	0	45459	FORGED BALL MOUNT 2	1	0
40019	2 X 3/4 X 3 HITCH B	12	0	40248	2 5/16X1 RCKR BALL	6	3	45069	GARAGE STORAGE ORG	4	0	45460	FORGED BALL MOUNT 2	1	0
40020	2 X 1 X 3 HITCH BAL	12	0	40249	2 5/16" RCKR BALL 1	6	3	45070	6" DROP BALL MOUNT	1	0	45500	HOOK,TOW,FORGE RCV	4	0
40021	2 5/16 X 1 X 3 HITCH	6	0	41200	2 IN REPLACEMENT BA	1	0	45071	2.5 IN GARAGE STORA	1	0	45503	BALL MOUNT,1.0"D,3	1	0
40022	2 5/16 X 1 1/4 X 3	6	0	41201	2 IN REPLACEMENT BA	50	0	45080	6" DROP BALL MOUNT	1	0	45507	VERTICAL MOUNT BALL	1	0
40030	2-5/16 X 1-1/4 X 2-	6	0	41340	3/4 IN REPLACEMENT	1	0	45090	8" DROP BALL MOUNT	1	0	45510	CLASS I BALLMOUNT	1	0
40031	1 7/8 X1X2 3/16 X1	12	0	41341	3/4 IN REPLACEMENT	1	0	45100	8" DROP BALL MOUNT	1	0	45518	1 1/4 IN DROP W/ 6	1	0
40032	1 7/8X1X2 1/8X2 HIT	12	0	41352	SHANK COVER FOR 3/4	1	0	45110	10" DROP BALL MOUNT	1	0	45519	1 1/4 IN DROP W/ 9	1	0
40033	2 X 1 X 2 1/8 X 1 H	12	0	41353	SHANK COVER FOR 3/4	1	0	45112	10" DROP BALL MOUNT	1	0	45520	12 IN CLASS I AND I	4	0
40034	2X1X2 1/8X2 HITCH B	12	0	41355	SHANK COVER FOR 1 I	1	0	45131	2" DROP WELDED BM 5	4	0	45521	3 1/4 DROP W/ 7 1/8	6	0
40035	2 5/16X1 1/4X2 5/8	6	0	41780	1 7/8 IN REPLACEMENT	1	0	45134	2" DROP WELDED BM 7	2	0	45522	3 1/8 IN RISE X 14	1	0
40036	2 5/16X1 1/4X2 5/8	6	0	41781	1 7/8 IN REPLACEMENT	1	0	45141	2" X 2" STARTER KIT	2	0	45534	TOWING STARTER KIT,	1	0
40037	2 X 1 X 2 1/8 HITCH	12	0	41782	SWITCH BALL SET 3/4	6	0	45142	2" X 2" STARTER KIT	2	0	45551	BALL MOUNT,EURO,.75	1	0
40038	2 X 1 X 2 1/4 HITCH	12	0	42100	1 INCH REPLACEMENT	1	0	45143	ROCKER BALL STARTER	2	0	45552	BALL MOUNT,EURO,.75	1	0
40039	2 5/16 X 1 X 2 1/4	12	0	42103	1 IN REPLACEMENT SH	1	0	45144	ROCKER BALL STARTER	2	0	45554	TOWING STARTER KIT,	1	0
40042	2 5/16X1X2 1/4 HITCH	12	0	42178	1 IN SHANK WITH 1 7	6	0	45147	1-1/4" X 1-1/4" STA	6	0	45561	BALL MOUNT,EURO,3.1	1	0
40047	2" X 1" ROCKER BALL	3	0	42200	2 IN REPLACEMENT BA	1	0	45148	1 1/4" X 1 1/4" STA	6	0				

MP = MASTER PACK / IP = INNER PACK

Part #	Description	MP	IP	Part #	Description	MP	IP	Part #	Description	MP	IP	Part #	Description	MP	IP
45562	BALL MOUNT,EURO,3.1	1	0	45917	SHANK,BM,FRG,REPL 4	1	0	48551	REPL SAFTY CHAIN HO	1	0	52011	NYLON BREAKAWAY SWI	15	0
45571	BALL MOUNT,EURO,2.6	1	0	45919	PINTLE,COMBO,ADJUS	1	0	48552	REPL HARWARE CHANN	1	0	52020	REPLACE LANYARD	600	300
45572	BALL MOUNT,EURO,2.6	1	0	45920	PINTLE,COMBO,ADJUS	1	0	48553	60K HARDWARE 48560	1	0	52021	PACKAGED LANYARD WI	24	6
45591	BALL MOUNT,EURO,3.1	1	0	45921	ANTI-RATTLE RUBBER	50	0	48560	60000 GTW - FORGED	3	0	52022	CURT BATTERY BOX	40	0
45592	BALL MOUNT,EURO,3.1	1	0	45922	PINTLE,COMBO,ADJ.2.	1	0	48600	12000 GTW - 3 IN AD	1	0	52023	CURT 12V 5.4 AMP RE	10	0
45650	TRIPLE TOW BAR 1 7/	1	0	45923	BALL,ADJ DUAL,REPL	1	0	48601	12000 GTW - 3 IN AD	1	0	52025	CURT 12V BATTERY CH	100	0
45651	TRIPLE TOW BAR 2.5"	2	0	45924	BALL, ADJ DUAL, REP	1	0	48610	3 POSITION CHANNEL	1	0	52027	CURT BATTERY CASE	60	0
45652	TRIPLE TOW BAR 1-7/	2	0	45925	ONE MNT PIN AND CLI	1	0	48620	E-62 BOLT KIT,FOR E	1	0	52029	CURT BATTERY BOX	40	0
45655	TRIPLE TOW BAR 1 7/	1	0	45926	2" DEEP DROP FORGED	1	0	48621	48620 PACKAGED BOLT	6	0	52030	CURT BATTERY BOX	40	0
45660	DOUBLE TOW BAR 2 IN	1	0	45927	2.5" DEEP DROP FORG	1	0	48625	12.5 TON LUNETTE E	1	1	52040	CURT SOFTTRAC I BRE	4	0
45665	DOUBLE TOW BAR 2 IN	1	0	45928	3" DEEP DROP FORGED	1	0	48626	20 TON LUNETTE EYE	1	1	52041	CURT SOFTTRAC I BRE	4	0
45675	TRIBALL W/HOOK 1-7/	1	0	45931	WD DUAL BALL REPL P	25	0	48630	3 IN ID EYE KIT W/3	1	0	52042	BREAKAWAY KIT,PUSH	4	0
45770	ADAPTABLE HITCH EXT	1	0	45932	RXD KEYED ALIKE LOC	12	3	48631	3 IN ID EYE KIT W/3	1	0	52044	BREAKAWAY KIT,PUSH	4	0
45775	ADAPTABLE HITCH EXT	1	0	45933	DUAL BALL WD SHANK	1	1	48640	3 IN ID EYE KIT W/5	1	0	53200	TOWING LIGHTS, 20",	10	0
45781	2" HITCH EXTENDER 8	1	0	45934	HD DUALL BALL WD SH	1	1	48641	KIT 20T LUNETTE W L	1	1	53201	LED CARGO LIGHTS	30	0
45785	RECEIVER TUBE ADAPT	4	0	45935	2" WD ADJ MOUNT DUA	1	1	48650	5 POSITION CHANNEL	1	0	53204	4-WAY FLAT MAGNETIC	1	0
45789	RECEIVER TUBE EXTEN	1	0	45936	2" DEEP DROP WD ADJ	1	1	48651	SECURE LATCH CHANNE	280	0	53440	RED COMBINATION LIG	1	0
45790	ADAPTABLE HITCH EXT	1	0	45937	2.5" HD WD ADJ MOUN	1	1	48660	12 TON FORGED 3 IN	350	0	53441	RED COMBINATION LIG	1	0
45791	ADAPTABLE HITCH EXT	100	0	45938	REB XD TONGUE LOCK	12	3	48661	30 TON LUNETTE 4 H	1	1	53445	RED REAR REPLACEMEN	1	0
45792	MULTI-USE RECEIVER	1	0	45939	2.5" DEEP DROP HD W	1	1	48810	1 7/8 IN REPLACEMEN	6	0	53515	RED SIDE REPLACEMEN	1	0
45794	ADAPTER,RECEIVER TU	1	0	45940	RXD REPLACE TON	4	0	48820	2 IN REPLACEMENT BA	6	0	53540	STOP TAIL AND SIDE	1	0
45795	ADAPTABLE HITCH EXT	1	0	45950	RXD PINTLE MOUNT AC	4	0	48830	2 5/16 IN REPLACEME	6	0	55151	WIRING KIT, T-CONN,	18	0
45796	ADAPTABLE HITCH EXT	100	0	45951	REBELLION XD W/ DUA	1	1	49060	6 IN RECEIVER TUBE	1	0	55152	WIRING KIT. T-CONN,	18	0
45797	2" RISE/DROP RECEIV	1	0	45952	REBELLION XD DUAL B	3	0	49090	9 IN RECEIVER TUBE	1	0	55177	3 WIRE TO 2 WIRE CO	1	0
45798	4" RISE/DROP RECEIV	1	0	45953	REBELLION XD DUAL B	4	0	49120	12 IN RECEIVER TUBE	1	0	55179	4 FLAT 3 TO 2 CONVE	72	6
45799	ADJUSTABLE MULTI-BA	1	0	45955	REBELLION XD BALL M	1	0	49180	18 IN RECEIVER TUBE	1	0	55417	2020 GM 7-WAY ADAPT	10	0
45800	BALL MOUNT,MB,ADJ,R	2	0	45959	REBELLION XD REPLAC	25	0	49240	24 IN RECEIVER TUBE	1	0	56080	EXTENSION,5TH WHEEL	12	0
45801	SHANK,D-900 REPLACE	1	0	45960	REBELLION XD REPLAC	50	0	49360	36 IN RECEIVER TUBE	1	0	56130	CONVERTER,BASIC,PAC	18	0
45802	REPL ADJ TUBE MNT,	4	0	48004	PINTLE,RCVR MNT,10	1	0	49480	48 IN RECEIVER TUBE	1	0	56175	CONVERTER,CP,PACKAG	18	0
45803	1" CLEVIS PIN	20	0	48005	PINTLE,RCVR MNT,5 T	1	0	49506	6 IN RECEIVER TUBE	1	0	56187	CONVERTER,BASIC,PWR	18	0
45804	5/8" CLEVIS PIN	20	0	48006	PINTLE,COMB,RCVR MN	1	0	49510	2.5" RECEIVER TUBE	1	0	56190	CONVERTER,HD W/SMA	18	0
45805	1/2" CLEVIS PIN	20	0	48007	PINTLE,COMB,RCVR MN	1	0	49511	2.5" RECEIVER TUBE	1	0	56196	CONVERTER,2-WIRE TO	18	0
45806	SAFETY CHAIN HOLDER	6	0	48010	2.5" REC MOUNT PINT	1	0	49512	12 IN RECEIVER TUBE	1	0	56236	CONVERTER,MULTI-FUN	14	0
45807	STEEL SAFETY CHAIN	1	0	48011	2" ADJUSTABLE SHANK	1	0	49513	3" RECEIVER TUBE 12	4	0	56424	BOARD, CONVERTER 24	18	0
45808	6" RISE/DROP RECEIV	1	0	48012	2.5" REC MNT PINTLE	1	0	49515	3" RECEIVER TUBE 18	2	0	56476	4-FLAT TRAILER END	12	0
45809	3/4" CLEVIS PIN	24	0	48016	2-1/2" ADJUSTABLE S	1	0	49516	2.5" RECEIVER TUBE	1	0	56496	POTTED TAILLIGHT CO	12	0
45810	MULTI-USE BALLMOUNT	1	0	48180	1 7/8 IN BALL AND P	4	0	49517	3" RECEIVER 12" LEN	4	0	56497	56496 30 PACK	18	0
45812	ADJUSTABLE BALL MOU	4	0	48190	2 IN BALL AND PINTL	4	0	49518	3" RECEIVER 18" LEN	2	0	56601	7 WAY MOLDED TRLR E	12	0
45820	SWAY CONTROL BALMO	1	0	48200	8 TON COMBO BALL AN	4	0	49524	24 IN RECEIVER TUBE	1	0	56602	7 WAY MOLDED TRLR E	12	0
45821	CLEVIS PIN BALL MOU	4	0	48205	5 TON GTW - REGULAR	4	0	49529	10 IN SOLID STEEL H	1	0	56603	7 WAY MOLDED TRLR E	12	0
45822	MOUNT,WELD ON SWAY	1	0	48210	10 TON GTW - REGULA	4	0	49530	12 IN SOLID STEEL H	1	0	56611	7 WAY COLD WEATHER	12	0
45825	MOUNT,TOW HOOK,CHR	2	0	48215	15 TON GTW - REGULA	4	0	49531	14 IN SOLID STEEL H	1	0	56612	7 WAY COLD WEATHER	12	0
45828	STRAIGHT BALL MOUNT	2	0	48231	30 TON GTW - REGULA	1	0	49533	18 IN SOLID STEEL H	1	0	56613	7 WAY COLD WEATHER	12	0
45829	STRAIGHT BALLMOUNT	2	0	48323	7 IN PLATE 8 1/2 IN	2	0	49536	24 IN SOLID STEEL H	1	0	56621	7 WAY MOLDED TRLR E	4	0
45830	2" DROP BALL MOUNT	2	0	48324	7 IN PLATE 10 1/2 I	2	0	49537	8 IN SOLID STEEL HI	1	0	56622	7 WAY MOLDED TRLR E	4	0
45831	TOW HOOK MOUNT 2-1/	1	0	48325	10 1/2" ADJUSTABLE	1	0	49770	3 IN X 3 IN X 1 IN	1	0	56623	7 WAY MOLDED TRLR E	4	0
45832	TOW HOOK MOUNT 2"	1	0	48326	8 1/2" PINTLE MOUNT	1	0	49950	10000 LB WELD-ON SA	1	0	57001	WIRE, 16-4, W7/BW/Y	20	0
45834	2" DROP LOADED 1-7/	2	0	48327	10 1/2" PINTLE MOUN	1	0	51114	MOUNTING BRACKET, C	100	0	57003	VW 7-WAY ADAPTOR	5	0
45836	2" DROP LOADED 2" B	2	0	48328	8 1/2" ADJUSTABLE P	1	0	51116	BRK CNTRLR, VENTURE	9	0	57004	ADAPTOR,7 TO 4/5,LE	36	0
45840	2" DROP BALL MOUNT	2	0	48329	2.5" ADJUSTABLE PIN	2	0	51124	KIT,REPLACE BRK HDW	100	0	57005	ADAPTOR,7 TO 6,LED	36	0
45850	4" DROP BALL MOUNT	2	0	48332	BOLT KIT FOR PINTLE	1	0	51125	MOUNTING BRACKET, C	100	0	57007	KIT,7-WAY EXT, ISOL	50	0
45855	4" DROP LOADED 1-7/	2	0	48333	48330 PACKAGED BOLT	6	0	51126	BRK CNTRL, DISCOVER	9	0	57016	SAE 7/4 BRACKET WIT	1	0
45856	4" DROP LOADED 2" B	2	0	48334	REPL BOLT KIT FOR P	1	0	51146	BRK CNTRL, TRIFLEX	9	0	57032	WIRE, SPOOL, 250FT,	2	0
45860	4" DROP BALL MOUNT	2	0	48340	2.5" PINTLE MOUNT	1	0	51160	BRAKE CONTROLLER -	10	0	57033	WIRE, SPOOL, 250FT,	2	0
45870	6" DROP BALL MOUNT	2	0	48341	13 IN PLATE 12 1/2	2	0	51170	SPECTRUM - BRAKE CO	12	0	57034	WIRE, SPOOL, 500FT,	2	0
45880	6" DROP BALL MOUNT	2	0	48342	13 IN PLATE 14 1/2	1	0	51180	ECHO MOBILE BRAKE C	6	0	57035	WIRE, SPOOL, 500FT,	2	0
45890	8" DROP BALL MOUNT	2	0	48343	2" PINTLE MOUNT, 17	1	0	51186	ECHO SAFETY STRAP	50	0	57036	WIRE, SPOOL, 500FT,	2	0
45891	8" DROP BALL MOUNT	2	0	48348	2.5" FORGED PINTLE	1	0	51189	ECHO MANUAL OVERRID	27	0	57037	WIRE, SPOOL, 500FT,	2	0
45892	10" DROP BALL MOUNT	2	0	48349	2.5" FORGED PINTLE	1	0	51190	ECHO UNDERDAS BRAK	18	0	57040	7-POLE ROUND TO 4 F	150	75
45893	10" DROP BALL MOUNT	2	0	48405	7 TON PINTLE HOOK W	1	0	51200	ECHO-INLINE BRAKE C	4	0	57041	7-POLE ROUND TO 4 F	80	10
45900	BALL MOUNT,FORGED,D	1	0	48406	7 TON COMBO BALL 2-	1	0	51420	BRAKE CONTROL HARN	50	0	57100	SOCKET,MFUNC,7WBL,	5	0
45901	BALL MOUNT,FORGED,D	1	0	48407	7 TON COMBO BALL RI	1	0	51421	BRAKE CONTROL HARN	1	0	57102	SOCKET,MFUNC,7WBL,	5	0
45902	BALL MOUNT,FR,DL 2/	1	0	48410	10 TON COMBO BALL 2	1	1	51431	BRAKE CONTROL HARN	1	0	57183	4-WAY FLAT TO 6-WAY	48	6
45903	SLIM BM FORGED DUAL	1	0	48411	10 TON COMBO BALL 2	1	1	51444	HARN,BK CTRL,JEEP G	1	0	57184	4-WAY FLAT TO 7-WAY	48	6
45904	ADJ FORGED BM WITH	45	0	48420	2" REPL BALL RING C	9	0	51500	KIT,BRK CNTRL WIRIN	12	0	57185	4-WAY FLAT TO 7-WAY	1	0
45907	13K CHANNEL MOUNT	1	0	48430	2-5/16" REPL BALL R	1	0	51515	HARN,BK CTRL,QP W/P	50	0	57186	4-FLAT TO 7-WAY W/B	5	0
45908	20K CHANNEL MOUNT	1	0	48505	15 TON PINTLE HOOK	1	1	51516	HARN,BK CTRL,QP W/P	36	0	57187	5-WAY FLAT TO 4-WAY	6	0
45909	CHANNEL MOUNT STEP	1	0	48510	22000 GTW - ALLOY S	1	0	51520	HARN,BRK CTRL,D-T T	36	0	57201	BRKT,MNT,7WAY,UNV,L	5	0
45910	SHANK,BM,FORGE,REP	1	0	48520	15000 GTW - ALLOY S	1	0	51521	TEST BOX, BRAKE CON	1	0	57202	MOUNTING BRKT, LONG	72	0
45911	SHANK,BM,ADJ,REPL 4	1	0	48530	45000 GTW - ALLOY S	1	0	51531	MERCEDES, SPRINTER	50	0	57203	BRKT,MNT,7WAY,UNV,S	6	0
45912	BALL,ADJ DUAL,REPL	1	0	48549	ADJ SLIDE PINTLE RE	1	0	51532	BRK CNTR ADAPTER TK	36	0	57204	MOUNTING BRKT,SHORT	72	0
45916	ANTI-RATTLE SET SCR	1	0	48550	35000 GTW - ALLOY S	3	0	52010	NYLON BREAKAWAY SWI	120	60				

MP = MASTER PACK / IP = INNER PACK

Part #	Description	MP	IP	Part #	Description	MP	IP	Part #	Description	MP	IP	Part #	Description	MP	IP
57205	BRKT,MNT,7WAY,HD,12	6	0	58090	6 POLE DIE CAST CON	140	70	58531	5-FLAT CAR END 60 I	80	10	70006	TOW BAR SAFETY CABL	10	0
57206	BRKT,MNT,7WAY,HD,PK	36	12	58091	6 POLE DIE CAST CON	80	10	58540	5-FLAT TRAILER END	120	60	70007	TOW BAR SAFETY CABL	10	0
57207	BRKT,MNT,456 WAY RN	1	0	58092	1-8/1-9 6-POLE DIE	100	50	58541	5-FLAT TRAILER END	80	10	70008	TOW BAR SAFETY CABL	12	0
57208	BRKT,MNT,456 WAY RN	100	0	58093	1-8/1-9/1-21 6-POLE	48	6	58550	5-FLAT LOOP 72 IN B	100	50	70010	RAMBLE TOWBAR COVE	10	0
57220	1-420 4-FLAT 20' TR	36	6	58120	6 POLE PL CONN, TRA	200	100	58551	5-FLAT LOOP 72 IN P	80	10	80136	CABLE, TRAILER SAFE	40	2
57224	4 POLE ROUND TO 4 F	400	200	58130	6-POLE CONNECTOR, C	200	150	58650	12 VOLT CIRCUIT TES	250	125	80151	CABLE, TRAILER SAFE	30	2
57225	4 POLE ROUND TO 4 F	24	6	58140	7 POLE PLASTIC CONN	200	100	58671	1-6/1-7, 4 POLE DIE	80	10	80176	CABLE, TRAILER SAFE	20	2
57240	7-WAY RV ROUND TO 4	180	90	58141	7 POLE PLASTIC CONN	80	10	58677	1-6/1-7/1-21 PKG.	48	6	81360	SNAP HOOK WITH 5/8	1	0
57241	7-WAY RV ROUND TO 4	80	10	58145	HD 7-WAY TRAILER-SI	80	10	58750	DUST COVER TRAILER	1.2K	600	81999	YELLOW ZINC LATCH K	1	0
57245	7 TO 4 W/LED DUST C	36	0	58150	7 POLE PLASTIC CONN	150	75	58761	DUST COVER SET	200	100	82610	1/4 IN THREADED LIN	300	0
57250	7-WAY RV (FLAT CONN	150	75	58151	7-POLE PLASTIC CONN	48	6	58823	1/4 IN CONVULUTED S	1	0	82611	1/4 IN THREADED LIN	200	0
57251	7-WAY RV (FLAT CONN	80	10	58152	PKG 1-14/1-15/1-51	48	6	58919	RV HARNESS, NPWR CO	12	0	82900	5/16 IN THREADED LI	200	0
57255	7 TO 6 AUX W/LED DU	36	0	58155	HD 7-WAY RV-STYLE 7	48	6	58920	RV HARNESS, PWR CON	12	0	82901	5/16 IN THREADED LI	200	0
57260	7-WAY RV ROUND TO 6	160	80	58160	7-POLE DIE-CAST CON	60	30	58979	RV, SPLICE IN HARNE	12	0	82903	5/16" QUICK LINK 2	100	0
57261	7-WAY RV STYLE (FLA	80	10	58161	CONN,7-POLE DIECAST	8	6	58980	RV HARNESS - 7 WAY	1	0	82930	3/8 IN THREADED LIN	150	0
57265	7 TO 6 BRAKE W/LED	16	0	58170	7-POLE DIE-CAST CON	50	25	58981	RV HARNESS - 6 WAY	1	0	82931	7/16 IN THREADED LI	120	0
57271	7-WAY TO 4-WAY 7506	12	0	58180	7-POLE DIE CAST CON	20	0	58999	BAG, KIT, RV HARNES	18	0	82932	1/2 IN THREADED LIN	80	0
57280	RV 7 TO 4-FLAT COIL	12	0	58181	CONN,7-POLE DIECAST	48	6	59187	CONVERTER,BASIC,PWR	12	0	82933	3/8 IN THD LINK 220	24	0
57281	7-WAY ADAPTOR 75065	12	0	58190	7-POLE METAL CONNEC	120	60	59190	CONVERTER,HD,PWRKIT	12	0	82934	2640LB THREADED LIN	6	0
57282	RV 7 TO 5-FLAT COIL	5	0	58200	4-FLAT CAP,CARSIDE	200	0	59236	CONVERTER,MULTI-FUN	12	0	82940	9/0 JOINING LINK RA	100	0
57283	RV 7 TO 6 COILED AD	10	5	58201	4-FLAT CAP,CARSIDE,	24	0	59421	22-18 G BUTT CONNEC	1	0	82942	7/16 IN JOINING LIN	100	0
57284	RV 7 TO 7 COILED AD	10	5	58202	COVER, 5-FLAT, CARS	500	0	59422	16-14 G BUTT CONNEC	1	0	82944	7/16 IN JOINING LIN	100	0
57285	RV 7 TO 4 RND COILE	10	5	58203	COVER, 5-FLAT, CARS	24	0	59423	12-10 G BUTT CONNEC	1	0	83001	RATCHET, 1" X 10',	1	0
57286	RV 6 TO 6 COILED AD	10	5	58210	BRACKET FOR CONNECT	150	0	59432	16-14 G MALE QUICK	1	0	83002	RATCHET, 1" X 16',	1	0
57404	4 FLAT TO 4 FLAT 1.	24	6	58220	7-POLE METAL CONNEC	100	50	59433	12-10 G MALE QUICK	1	0	83009	RATCHET, 1" X 10',	1	0
57405	4-FLAT TO 4-FLAT 1.	24	6	58222	BRACKET FOR CONNECT	1	0	59496	POTTED CONVERTER W/	12	0	83010	RATCHET, 1" X 16',	1	0
57444	4 WAY ROUND TO 4 WA	150	75	58230	BRACKET FOR CONNECT	200	0	59521	16-14 G 10 RING TER	1	0	83015	CAM TIE DOWN, 1" X	1	0
57505	12 VOLT CIRCUIT TES	300	150	58231	BRACKET FOR CONNECT	100	0	59522	16-14 G 1/4 IN RING	1	0	83016	CAM TIE DOWN, 1" X	1	0
57604	4-WAY FLAT TO BOTH	36	6	58240	TAIL LIGHT CONVERTE	150	75	59523	16-14 G 3/8 IN RING	1	0	83019	RATCHET, 1" X 16',	1	0
57620	6-WAY ROUND TO 4-WA	400	200	58260	LED 4-FLAT TESTER	1K	0	59525	16-14 G 5/16 IN RIN	1	0	83020	RATCHET, 1" X 16',	1	0
57621	6-WAY ROUND TO 4-WA	24	6	58261	LED 4-FLAT TESTER,P	60	0	59531	12-10 G 10 RING TER	1	0	83025	RATCHET, 1-1/16" X	1	0
57624	4 WAY FLAT TO BOTH	36	6	58267	NEW 2" GM TAILGATE	4	0	59534	12-10 G 1/4 IN RING	1	0	83027	RATCHET, 1-1/16" X	1	0
57626	6 WAY ROUND TO 4 WA	36	6	58270	12V 7-WAY RV ROUND	150	75	59538	12-10 G 3/8 IN RING	1	0	83028	RATCHET, 1-1/16" X	1	0
57627	6 TO 4 W/LED DUST C	36	0	58272	7-WAY LED RV BLADE	150	0	59556	12-10 G 5/16 IN RIN	1	0	83036	RATCHET, 1-1/2" X 1	1	0
57660	7-WAY RV TO 6 ROUND	160	80	58273	7-WAY LED RV BLADE	18	0	59592	16-14 G FEMALE QUIC	1	0	83047	RATCHET, 2" X 27',	1	0
57661	7-WAY RV TO 6 ROUND	80	10	58280	14-18 GAUGE WIRE CO	1	0	59593	12-10 G FEMALE QUIC	1	0	83048	RATCHET, 2" X 27',	1	0
57667	6-WAY ROUND TO 7-WA	36	6	58290	BLACK BRACKET FOR C	200	0	59611	22-18 G SPADE TERMI	1	0	83050	2 IN X 27 FT RATCHE	1	0
57672	4 WAY FLAT TO BOTH	24	6	58291	PKG BLACK ZINC CONN	100	0	59621	16-14 G SPADE TERMI	1	0	83060	HIDE-A-TIE ROPE HOO	1	0
57674	4 WAY FLAT TO BOTH	24	6	58300	BRACKET,4-FLAT,BULK	200	0	59631	12-10 G SPADE TERMI	1	0	83061	HIDE-A-TIE ROPE HOO	1	0
57676	7 WAY ROUND TO 4 WA	24	6	58301	BRACKET,4-FLAT,PKG D	24	0	59728	7 1/4 IN NYLON WIRE	1	0	83066	2 IN X 30 FT VEHICL	1	0
57720	7 TO 6 ADPTR W/BKUP	48	6	58303	BRACKET, 5-WAY FLAT	24	6	59732	14 1/4 IN NYLON WIR	1	0	83072	WELD ON ANCHOR 1 5/	2.5K	0
57724	7 TO 4 ADPTR W/BKUP	36	6	58304	12 CAR END/12 TRAIL	24	6	59740	3/4 IN X 60 FT 10 P	1	0	83600	5000 GTW RECESSED F	100	0
57725	7 TO 5 ADPTR W/BKUP	36	6	58305	48 CAR END/12 TRAIL	24	6	59824	3/8 IN CONVULUTED S	1	0	83601	1200 GTW FOR USE WI	14	0
57726	7 TO 6 ADPTR W/BKUP	48	6	58306	4-WAY FLAT MAGNETIC	24	6	59825	3/8 X 25 FT SLIT LO	20	0	83607	BACKING PLATE FOR J	50	0
57727	7 TO 7 ADPTR W/BKUP	48	6	58310	FLASHES 1-4 32 CP T	500	0	59826	1/2 IN ID BLACK CONVOL	1	0	83610	ROUND RECESSED WALL	1	0
58000	BRACKET,ELEC,7WAY/4	20	0	58320	FLASHES 2-3 32 CP T	250	0	59827	1/2 X 25 IN SLIT LO	20	0	83710	1000 LB CAPACITY 1/	100	0
58001	BRACKET,ELEC,4FLAT	20	0	58341	15 AMP CIRCUIT BREA	216	12	59828	3/8 IN ID NYLON LOO	1	0	83720	BLACK PLASTIC TRIM	1	0
58002	BRACKET,ELEC,4FLAT	20	0	58344	12 CAR END/12 TRAIL	24	6	59901	WIRE NUTS - 100 PER	1	0	83730	1200 LB CAP 10 GA S	500	0
58003	BRACKET,ELEC,7WAY/4	20	0	58345	4-FLAT CAR END 60",	24	6	59905	12-10 GAUGE QUICK S	1	0	83731	1,200 LB CAP, 10 GA	40	0
58020	2-FLAT LOOP 12 IN B	400	0	58348	48 TRAILER END	24	6	59906	14-18 GAUGE QUICK S	1	0	83732	1200 LB CAP 10 GA S	500	0
58021	2-FLAT LOOP 12 IN P	200	100	58349	48 TRAILER END KIT	24	6	59956	18-14 GAUGE TAP CON	1	0	83740	11000 LB CAPACITY 1	100	0
58030	4 WAY FLAT 12 IN TR	100	300	58351	20 AMP CIRCUIT BREA	216	12	60601	60601 OE GOOSEBALL	8	1	83742	WHITE ZINC D-RING A	100	0
58031	4 WAY FLAT 12 IN TR	200	100	58355	48 CAR END/12 TRAIL	36	6	60602	ROUND SHANK BALL EX	1	0	83750	18800 LB CAP 5/8 IN	25	0
58032	4 WAY FLAT 48" BULK	100	0	58361	30 AMP CIRCUIT BREA	216	12	60603	ROUND SHANK HIGH RI	1	0	83760	26500 LB CAP 3/4 IN	1	0
58033	1-3 4-FLAT TRAILER	1	0	58371	40 AMP CIRCUIT BREA	216	12	60616	600 SERIES REPLACEM	5	0	83770	46760 LB CAP 1 IN F	1	0
58034	6 WAY SQUARE W/12"	36	0	58380	4-WAY BONDED 12 BON	300	150	60627	2-5/16" OE GOOSEBAL	8	0	83780	46760 LB CAP 1 IN X	8	0
58035	6 WAY SQUARE CAR EN	1	0	58381	4-WAY BONDED 12 BON	24	6	60628	3" OE GOOSEBALL 30K	4	0				
58037	6 WAY SQUARE TRLR E	1	0	58390	PULL WIRE 3/8 IN	1	0	60629	2-5/16" OE GOOSEBAL	8	0				
58040	4 WAY FLAT 60 IN CA	200	100	58400	PULL WIRE 1/2 IN	1	0	60634	3" OE GOOSEBALL 38K	4	0				
58041	4 WAY FLAT 60 IN CA	24	6	58404	4 FLAT TO 4 FLAT 1.	300	150	60654	2-5/16" ROCKERBALL,	1	0				
58042	4 WAY FLAT 48 AND 1	1	0	58405	4-FLAT TO 4-FLAT 1.	200	100	60910	GOOSENECK ISOLATOR	1	0				
58044	1-4 4-FLAT CAR END	24	6	58410	PULL WIRE 7/16 IN	1	0	66112	QUICK GOOSE CHROME	1	0				
58050	4 WAY BONDED 72 IN	150	75	58414	4 WAY ROUND TO 4 WA	300	150	66113	SAFETY CHAIN U-BOLT	1	0				
58051	4-WAY BONDED 72 IN	80	10	58417	7 WAY RV SOCKET WIT	48	6	66123	T-HANDLE WITH COTTE	1	0				
58060	4 POLE DIE CAST CON	300	150	58430	PULL WIRE 5/8 IN	1	0	66127	CHROME PLATED STEEL	1	0				
58061	PKG D-4-WAY DIE CAST	24	6	58440	FUSE,10 AMP ATC,BUL	1	0	66155	REPLACEMENT CAP FOR	500	0				
58070	4 POLE DIE CAST CON	100	50	58450	FUSE,15 AMP ATC,BUL	1	0	66165	REPLACEMENT CAP FOR	500	0				
58071	PKG D-7-WAY DIE CAST	80	10	58460	FUSE,20 AMP ATC,BUL	1	0	70001	7500 LB STEEL TOW B	1	0				
58080	6 POLE DIE CAST CON	300	150	58470	HOLDER, IN-LINE FUS	12	0	70002	BASE PLATE INSERT T	10	0				
58081	6 POLE DIE CAST CON	24	6	58510	BRACKET FOR 1-15/1-	100	0	70003	BASE PLATE INSERT T	10	0				
58082	6-POLE DIE CAST CON	1	0	58520	BRACKET,U.S. CAR 7	200	0	70004	TOWING ACCESSORIES	4	0				
58083	CONN,6-POLE DIECAST	48	6	58530	5-FLAT CAR END 60 I	120	60	70005	KEYED ALIKE LOCKS 5	12	3				

MP = MASTER PACK / IP = INNER PACK

CUSTOM WIRING PRODUCTS LISTED NUMERICALLY

Part #	Years	Make / Model	Master Pk	Part #	Years	Make / Model	Master Pk	Part #	Years	Make / Model	Master Pk
55050	07-07	DODGE CALIBER	12	55311	73-74	CHEVROLET K20 PICKUP	18	55316	87-97	FORD F-350	18
55050	07-10	JEEP COMPASS	12	55311	73-84	CHEVROLET K20 SUBURBAN	18	55317	94-94	DODGE B250	18
55050	07-07	JEEP PATRIOT	12	55311	77-84	CHEVROLET K30	18	55317	86-89	DODGE D100	12
55057	03-08	PONTIAC VIBE	12	55311	73-74	CHEVROLET K30 PICKUP	18	55317	86-93	DODGE D150	12
55106	07-11	HONDA CR-V	12	55311	75-84	CHEVROLET K5 BLAZER	18	55317	86-93	DODGE D250	12
55124	07-18	JEEP WRANGLER	18	55311	75-78	GMC C15	18	55317	86-93	DODGE D350	12
55240	96-03	CHEVROLET EXPRESS 1500	18	55311	75-78	GMC C15 SUBURBAN	18	55317	87-94	DODGE DAKOTA	12
55240	96-03	CHEVROLET EXPRESS 2500	18	55311	73-74	GMC C15/C1500 PICKUP	18	55317	94-94	DODGE RAM 1500	12
55240	96-03	CHEVROLET EXPRESS 3500	18	55311	73-74	GMC C15/C1500 SUBURBAN	18	55317	94-94	DODGE RAM 2500	12
55240	96-03	GMC SAVANA 1500	18	55311	79-84	GMC C1500	18	55317	94-94	DODGE RAM 3500	12
55240	96-03	GMC SAVANA 2500	18	55311	79-84	GMC C1500 SUBURBAN	18	55317	86-93	DODGE RAM 50	12
55240	96-03	GMC SAVANA 3500	18	55311	75-78	GMC C25	18	55317	86-93	DODGE RAMCHARGER	12
55241	95-01	FORD EXPLORER	18	55311	75-78	GMC C25 SUBURBAN	18	55317	86-89	DODGE W100	12
55241	98-99	FORD RANGER	18	55311	73-74	GMC C25/C2500 PICKUP	18	55317	86-93	DODGE W150	12
55241	98-01	MAZDA B2500	18	55311	73-74	GMC C25/C2500 SUBURBAN	18	55317	86-93	DODGE W250	12
55241	98-01	MAZDA B3000	18	55311	79-84	GMC C2500	18	55317	86-93	DODGE W350	12
55241	98-01	MAZDA B4000	18	55311	79-84	GMC C2500 SUBURBAN	18	55319	99-00	CADILLAC ESCALADE	12
55241	97-01	MERCURY MOUNTAINEER	18	55311	75-78	GMC C35	18	55319	92-94	CHEVROLET BLAZER	18
55242	97-03	FORD F-150	5	55311	73-74	GMC C35/C3500 PICKUP	18	55319	92-99	CHEVROLET C1500 SUBURBAN	18
55242	04-04	FORD F-150 HERITAGE	5	55311	79-84	GMC C3500	18	55319	92-99	CHEVROLET C2500 SUBURBAN	18
55242	97-99	FORD F-250	5	55311	75-78	GMC K15	18	55319	92-99	CHEVROLET K1500 SUBURBAN	18
55243	99-01	FORD F-250 SUPER DUTY	5	55311	75-78	GMC K15 SUBURBAN	18	55319	92-99	CHEVROLET K2500 SUBURBAN	18
55243	99-01	FORD F-350 SUPER DUTY	5	55311	73-74	GMC K15/K1500 PICKUP	18	55319	95-00	CHEVROLET TAHOE	18
55243	99-01	FORD F-450 SUPER DUTY	5	55311	73-74	GMC K15/K1500 SUBURBAN	18	55319	92-99	GMC C1500 SUBURBAN	18
55243	99-01	FORD F-550 SUPER DUTY	5	55311	79-84	GMC K1500	18	55319	92-99	GMC C2500 SUBURBAN	18
55244	00-04	NISSAN XTERRA	18	55311	79-84	GMC K1500 SUBURBAN	18	55319	92-99	GMC K1500 SUBURBAN	18
55245	01-07	LEXUS LX470	18	55311	75-78	GMC K25	18	55319	92-99	GMC K2500 SUBURBAN	18
55245	08-11	LEXUS LX570	18	55311	75-78	GMC K25 SUBURBAN	18	55319	92-00	GMC YUKON	18
55245	01-03	LEXUS RX300	18	55311	73-74	GMC K25/K2500 PICKUP	18	55319	00-00	GMC YUKON XL 1500	18
55245	24-24	LEXUS TX350	18	55311	73-74	GMC K25/K2500 SUBURBAN	18	55319	00-00	GMC YUKON XL 2500	18
55245	24-24	LEXUS TX500H	18	55311	79-84	GMC K2500	18	55323	91-95	CHRYSLER TOWN & COUNTRY	18
55245	24-24	LEXUS TX550H+	18	55311	79-84	GMC K2500 SUBURBAN	18	55323	91-95	DODGE CARAVAN	18
55245	01-02	TOYOTA 4RUNNER	18	55311	77-78	GMC K35	18	55323	04-10	DODGE DAKOTA	18
55245	01-24	TOYOTA HIGHLANDER	18	55311	73-74	GMC K35/K3500 PICKUP	18	55323	91-95	DODGE GRAND CARAVAN	18
55245	01-02	TOYOTA LAND CRUISER	18	55311	79-84	GMC K3500	18	55323	06-09	MITSUBISHI RAIDER	18
55245	24-24	TOYOTA GRAND HIGHLANDER	18	55312	85-86	CHEVROLET C10	18	55323	91-95	PLYMOUTH GRAND VOYAGER	18
55246	01-02	TOYOTA SEQUOIA	18	55312	85-86	CHEVROLET C10 SUBURBAN	18	55325	93-99	FORD RANGER	18
55247	99-01	FORD F-250 SUPER DUTY	18	55312	94-94	CHEVROLET C1500	18	55325	94-08	MAZDA B2300	12
55247	99-01	FORD F-350 SUPER DUTY	18	55312	85-86	CHEVROLET C20	18	55325	98-01	MAZDA B2500	12
55251	02-05	FORD EXPLORER	18	55312	85-86	CHEVROLET C20 SUBURBAN	18	55325	94-07	MAZDA B3000	12
55251	03-05	LINCOLN NAVIGATOR	18	55312	85-86	CHEVROLET C30	18	55325	94-08	MAZDA B4000	12
55251	02-05	MERCURY MOUNTAINEER	18	55312	85-86	CHEVROLET K10	18	55326	92-97	FORD CROWN VICTORIA	12
55255	01-04	FORD ESCAPE	12	55312	85-86	CHEVROLET K10 SUBURBAN	18	55326	94-04	FORD MUSTANG	12
55255	01-04	MAZDA TRIBUTE	12	55312	85-86	CHEVROLET K20	18	55326	92-97	MERCURY GRAND MARQUIS	12
55256	97-04	FORD F-150	12	55312	85-86	CHEVROLET K20 SUBURBAN	18	55329	95-03	DODGE DAKOTA	18
55256	97-99	FORD F-250	18	55312	85-86	CHEVROLET K30	18	55329	95-01	DODGE RAM 1500	18
55260	95-98	JEEP GRAND CHEROKEE	18	55312	85-97	CHEVROLET S10	18	55329	95-02	DODGE RAM 2500	18
55265	02-04	FORD F-250 SUPER DUTY	18	55312	85-86	GMC C1500	18	55329	95-02	DODGE RAM 3500	12
55265	02-04	FORD F-350 SUPER DUTY	12	55312	85-86	GMC C1500 SUBURBAN	18	55334	00-00	CHRYSLER GRAND VOYAGER	12
55301	73-79	FORD F-150	12	55312	85-86	GMC C2500	18	55334	96-00	CHRYSLER TOWN & COUNTRY	12
55301	73-79	FORD F-250	12	55312	85-86	GMC C2500 SUBURBAN	18	55334	00-00	CHRYSLER VOYAGER	12
55301	73-79	FORD F-350	12	55312	85-86	GMC C3500	18	55334	96-00	DODGE CARAVAN	12
55307	01-05	TOYOTA RAV4	12	55312	85-86	GMC K1500	18	55334	98-03	DODGE DURANGO	12
55308	02-06	TOYOTA CAMRY	12	55312	85-86	GMC K1500 SUBURBAN	18	55334	96-00	DODGE GRAND CARAVAN	12
55309	02-05	KIA SEDONA	18	55312	85-86	GMC K2500	18	55334	96-00	PLYMOUTH GRAND VOYAGER	12
55310	09-12	HYUNDAI ELANTRA	18	55312	85-86	GMC K2500 SUBURBAN	18	55334	96-00	PLYMOUTH VOYAGER	12
55310	01-06	HYUNDAI SANTA FE	18	55312	85-86	GMC K3500	18	55335	96-99	CHEVROLET EXPRESS 1500	12
55310	06-11	KIA RIO5	18	55312	85-90	GMC S15	18	55335	96-99	CHEVROLET EXPRESS 2500	12
55311	73-74	CHEVROLET BLAZER	18	55312	91-97	GMC SONOMA	18	55335	96-99	CHEVROLET EXPRESS 3500	12
55311	75-84	CHEVROLET C10	18	55312	91-91	GMC SYCLONE	18	55335	96-99	GMC SAVANA 1500	12
55311	73-74	CHEVROLET C10 PICKUP	18	55312	96-97	ISUZU HOMBRE	18	55335	96-99	GMC SAVANA 2500	12
55311	73-84	CHEVROLET C10 SUBURBAN	18	55314	86-92	FORD RANGER	18	55335	96-99	GMC SAVANA 3500	12
55311	75-84	CHEVROLET C20	18	55315	88-99	GMC C1500	18	55336	97-03	ACURA CL	12
55311	73-74	CHEVROLET C20 PICKUP	18	55315	88-00	GMC C2500	18	55336	94-01	ACURA INTEGRA	12
55311	73-84	CHEVROLET C20 SUBURBAN	18	55315	88-00	GMC C3500	18	55336	01-06	ACURA MDX	12
55311	75-84	CHEVROLET C30	18	55315	88-99	GMC K1500	18	55336	96-01	ACURA RL	18
55311	73-74	CHEVROLET C30 PICKUP	18	55315	88-00	GMC K2500	18	55336	96-03	ACURA TL	18
55311	75-84	CHEVROLET K10	18	55315	88-00	GMC K3500	18	55336	94-02	HONDA ACCORD	18
55311	73-74	CHEVROLET K10 PICKUP	18	55316	87-96	FORD F-150	18	55336	97-06	HONDA CR-V	18
55311	73-84	CHEVROLET K10 SUBURBAN	18	55316	87-96	FORD F-250	18	55336	03-04	HONDA ELEMENT	18
55311	75-84	CHEVROLET K20	18	55316	97-97	FORD F-250 HD	18	55336	95-04	HONDA ODYSSEY	18

Part #	Years	Make / Model	Master Pk	Part #	Years	Make / Model	Master Pk	Part #	Years	Make / Model	Master Pk
55336	03-08	HONDA PILOT	18	55361	96-04	NISSAN PATHFINDER	12	55441	05-15	NISSAN XTERRA	18
55336	01-01	HONDA PRELUDE	18	55363	98-06	JEEP WRANGLER	12	55441	09-12	SUZUKI EQUATOR	12
55336	96-99	ISUZU OASIS	18	55365	98-99	LEXUS LX470	12	55451	05-06	JEEP GRAND CHEROKEE	12
55338	87-96	CHEVROLET G10	18	55365	98-99	TOYOTA LAND CRUISER	12	55486	96-00	TOYOTA RAV4	18
55338	87-96	CHEVROLET G20	18	55367	00-00	TOYOTA TUNDRA	12	55502	06-14	ACURA TSX	18
55338	87-96	CHEVROLET G30	18	55368	99-00	DODGE RAM 1500 VAN	12	55502	03-12	HONDA ACCORD	18
55338	87-96	GMC G1500	12	55368	99-00	DODGE RAM 2500 VAN	12	55504	02-05	DODGE RAM 1500	18
55338	87-96	GMC G2500	12	55368	99-00	DODGE RAM 3500 VAN	12	55504	03-05	DODGE RAM 2500	12
55338	87-96	GMC G3500	12	55369	99-04	JEEP GRAND CHEROKEE	12	55504	03-05	DODGE RAM 3500	12
55339	96-99	ACURA SLX	12	55370	06-07	SUBARU B9 TRIBECA	12	55510	04-12	CHEVROLET COLORADO	12
55339	92-02	ISUZU TROOPER	12	55370	98-08	SUBARU FORESTER	12	55510	04-12	GMC CANYON	18
55341	96-02	TOYOTA 4RUNNER	12	55370	04-04	SUBARU IMPREZA	12	55510	06-06	ISUZU I-280	18
55343	92-94	FORD E-150 ECONOLINE	18	55370	96-99	SUBARU LEGACY	18	55510	07-08	ISUZU I-290	18
55343	92-94	FORD E-150 ECO. CLUB WAGON	18	55370	00-09	SUBARU OUTBACK	18	55510	06-06	ISUZU I-350	18
55343	92-94	FORD E-250 ECONOLINE	12	55370	08-14	SUBARU TRIBECA	12	55510	07-08	ISUZU I-370	12
55343	92-94	FORD E-350 ECONOLINE	12	55371	98-02	KIA SPORTAGE	18	55513	08-12	TOYOTA HILUX	12
55343	92-94	FORD E-350 ECON. CLUB WAG.	12	55372	98-04	CHEVROLET TRACKER	18	55513	93-98	TOYOTA T100	12
55343	01-03	FORD ESCAPE	12	55372	96-97	GEO TRACKER	18	55513	05-15	TOYOTA TACOMA	12
55343	01-03	MAZDA TRIBUTE	12	55372	99-05	SUZUKI GRAND VITARA	12	55522	00-02	TOYOTA ECHO	12
55343	96-05	MERCURY SABLE	12	55372	89-98	SUZUKI SIDEKICK	12	55522	03-08	TOYOTA MATRIX	12
55344	03-03	FORD E-150	12	55372	99-04	SUZUKI VITARA	12	55528	05-09	HYUNDAI TUCSON	12
55344	03-03	FORD E-150 CLUB WAGON	12	55372	02-06	SUZUKI XL-7	12	55529	05-10	KIA SPORTAGE	12
55344	95-02	FORD E-150 ECONOLINE	12	55376	01-03	CHRYSLER TOWN & COUNTRY	12	55530	04-08	CHRYSLER PACIFICA	12
55344	95-02	FORD E-150 ECO. CLUB WAGON	18	55376	01-03	CHRYSLER VOYAGER	12	55532	01-10	CHRYSLER PT CRUISER	12
55344	03-03	FORD E-250	18	55376	01-03	DODGE CARAVAN	12	55534	05-10	CHRYSLER 300	12
55344	95-02	FORD E-250 ECONOLINE	18	55376	01-03	DODGE GRAND CARAVAN	12	55534	08-14	DODGE CHALLENGER	12
55344	03-03	FORD E-350 CLUB WAGON	18	55377	00-02	CHEVROLET EXPRESS 1500	18	55534	06-10	DODGE CHARGER	12
55344	95-98	FORD E-350 ECONOLINE	18	55377	00-02	CHEVROLET EXPRESS 2500	18	55537	04-07	CHRYSLER TOWN & COUNTRY	12
55344	95-02	FORD E-350 ECO. CLUB WAGON	18	55377	00-02	CHEVROLET EXPRESS 3500	18	55537	04-07	DODGE CARAVAN	12
55344	99-03	FORD E-350 SUPER DUTY	18	55377	00-02	GMC SAVANA 1500	18	55537	04-07	DODGE GRAND CARAVAN	12
55344	00-02	FORD E-450 ECO. SUPER DUTY	18	55377	00-02	GMC SAVANA 2500	18	55540	03-14	CHEVROLET EXPRESS 1500	12
55344	03-03	FORD E-450 SUPER DUTY	18	55377	00-02	GMC SAVANA 3500	18	55540	03-25	CHEVROLET EXPRESS 2500	12
55344	02-02	FORD E-550 ECO. SUPER DUTY	18	55378	01-02	TOYOTA TUNDRA	18	55540	03-25	CHEVROLET EXPRESS 3500	12
55344	03-03	FORD E-550 SUPER DUTY	18	55379	89-95	TOYOTA PICKUP	18	55540	03-14	GMC SAVANA 1500	18
55344	96-99	FORD ECONOLINE SUPER DUTY	18	55379	95-04	TOYOTA TACOMA	12	55540	03-25	GMC SAVANA 2500	12
55344	97-99	FORD ESCORT	18	55380	01-06	MITSUBISHI MONTERO	12	55540	03-25	GMC SAVANA 3500	12
55344	00-03	FORD EXCURSION	18	55381	07-09	CHRYSLER ASPEN	12	55542	03-13	TOYOTA COROLLA	12
55344	97-03	FORD EXPEDITION	18	55381	04-08	CHRYSLER PACIFICA	12	55546	05-10	CHRYSLER 300	12
55344	01-03	FORD EXPLORER	18	55381	00-09	DODGE DAKOTA	12	55550	03-06	KIA SORENTO	12
55344	02-03	FORD EXPLORER SPORT TRAC	18	55381	00-08	DODGE DURANGO	12	55551	04-04	FORD F-150	12
55344	97-03	FORD F-150	18	55381	00-08	DODGE RAM 1500	12	55551	04-04	FORD F-150 HERITAGE	12
55344	04-04	FORD F-150 HERITAGE	18	55381	01-03	DODGE RAM 1500 VAN	12	55560	05-06	CHEVROLET EQUINOX	12
55344	00-03	FORD FOCUS	18	55381	00-10	DODGE RAM 2500	12	55560	06-06	PONTIAC TORRENT	12
55344	00-03	FORD RANGER	18	55381	01-03	DODGE RAM 2500 VAN	12	55562	05-08	DODGE MAGNUM	12
55344	03-04	LINCOLN AVIATOR	18	55381	00-10	DODGE RAM 3500	12	55563	04-06	LEXUS RX330	12
55344	98-03	LINCOLN NAVIGATOR	18	55381	01-03	DODGE RAM 3500 VAN	12	55563	07-12	LEXUS RX350	12
55344	02-03	MERCURY MOUNTAINEER	18	55381	03-09	DODGE SPRINTER 2500	12	55567	14-18	MAZDA 3	12
55344	97-99	MERCURY TRACER	18	55381	03-09	DODGE SPRINTER 3500	12	55567	03-08	MAZDA 6	12
55345	95-01	FORD EXPLORER	18	55381	03-09	FREIGHTLINER SPRINTER 2500	18	55567	07-12	MAZDA CX-7	12
55345	97-01	MERCURY MOUNTAINEER	18	55381	03-09	FREIGHTLINER SPRINTER 3500	18	55567	07-17	TOYOTA CAMRY	12
55346	95-98	FORD WINDSTAR	18	55381	06-10	JEEP COMMANDER	18	55567	14-19	TOYOTA COROLLA	18
55347	91-96	BUICK ROADMASTER	12	55381	00-10	JEEP GRAND CHEROKEE	18	55567	07-14	TOYOTA FJ CRUISER	12
55347	91-96	CHEVROLET CAPRICE	12	55381	05-08	JEEP LIBERTY	18	55570	04-09	NISSAN QUEST	12
55347	94-96	CHEVROLET IMPALA	12	55381	06-09	MITSUBISHI RAIDER	18	55571	03-14	NISSAN MURANO	12
55349	94-98	JEEP GRAND CHEROKEE	18	55382	02-07	JEEP LIBERTY	18	55580	04-10	TOYOTA SIENNA	12
55350	92-96	FORD BRONCO	18	55383	02-07	BUICK RENDEZVOUS	18	55585	06-14	HONDA RIDGELINE	12
55353	87-95	NISSAN PATHFINDER	18	55383	01-05	PONTIAC AZTEK	18	55587	05-07	FORD FIVE HUNDRED	12
55353	95-97	NISSAN PICKUP	12	55400	06-11	HYUNDAI AZERA	18	55587	05-07	FORD FREESTYLE	12
55354	97-01	JEEP CHEROKEE	18	55400	01-07	TOYOTA HIGHLANDER	18	55593	07-12	MAZDA CX-7	12
55355	97-05	CHEVROLET VENTURE	18	55411	95-05	CHEVROLET ASTRO	18	55597	07-09	CHRYSLER ASPEN	12
55355	97-04	OLDSMOBILE SILHOUETTE	18	55411	95-02	CHEVROLET BLAZER	18	55597	04-09	DODGE DURANGO	12
55355	99-09	PONTIAC MONTANA	18	55411	95-01	GMC JIMMY	18	56000	99-18	CHEVROLET SILVERADO 1500	12
55355	97-99	PONTIAC TRANS SPORT	12	55411	95-05	GMC SAFARI	18	56000	07-07	CHEV. SILV. 1500 CLASSIC	12
55356	97-97	JEEP TJ	12	55411	96-01	OLDSMOBILE BRAVADA	18	56000	01-06	CHEV. SILVERADO 1500 HD	12
55356	91-97	JEEP WRANGLER	12	55414	06-10	JEEP COMMANDER	18	56000	07-07	CHEV. SILV. 1500 HD CLASSIC	12
55358	97-01	TOYOTA CAMRY	12	55418	98-03	TOYOTA SIENNA	18	56000	19-19	CHEV. SILVERADO 1500 LD	12
55359	98-04	CHEVROLET S10	12	55432	05-10	CHEVROLET COBALT	12	56000	99-04	CHEVROLET SILVERADO 2500	12
55359	98-04	GMC SONOMA	12	55432	06-11	CHEVROLET HHR	12	56000	01-19	CHEV. SILVERADO 2500 HD	12
55359	98-00	ISUZU HOMBRE	12	55432	07-10	PONTIAC G5	12	56000	07-07	CHEV. SILV. 2500 HD CLASSIC	12
55360	98-02	HONDA PASSPORT	12	55432	05-06	PONTIAC PURSUIT	12	56000	01-06	CHEVROLET SILVERADO 3500	18
55360	98-00	ISUZU AMIGO	12	55434	05-10	CHEVROLET COBALT	12	56000	07-07	CHEV. SILV. 3500 CLASSIC	18
55360	98-04	ISUZU RODEO	12	55434	07-10	PONTIAC G5	18	56000	08-19	CHEV. SILVERADO 3500 HD	12
55360	01-03	ISUZU RODEO SPORT	18	55434	05-06	PONTIAC PURSUIT	18	56000	09-10	DODGE RAM 1500	12
55361	97-03	INFINITI QX4	18	55441	05-24	NISSAN FRONTIER	18	56000	10-10	DODGE RAM 2500	12
55361	98-01	NISSAN ALTIMA	18	55441	05-10	NISSAN PATHFINDER	18	56000	10-10	DODGE RAM 3500	20

Part #	Years	Make / Model	Master Pk
56000	97-14	FORD F-150	20
56000	04-04	FORD F-150 HERITAGE	20
56000	97-99	FORD F-250	20
56000	97-97	FORD F-250 HD	20
56000	99-16	FORD F-250 SUPER DUTY	20
56000	99-24	FORD F-350 SUPER DUTY	20
56000	99-24	FORD F-450 SUPER DUTY	20
56000	99-24	FORD F-550 SUPER DUTY	20
56000	99-18	GMC SIERRA 1500	20
56000	07-07	GMC SIERRA 1500 CLASSIC	20
56000	01-06	GMC SIERRA 1500 HD	20
56000	07-07	GMC SIERRA 1500 HD CLASSIC	20
56000	19-19	GMC SIERRA 1500 LIMITED	20
56000	99-04	GMC SIERRA 2500	20
56000	01-19	GMC SIERRA 2500 HD	20
56000	07-07	GMC SIERRA 2500 HD CLASSIC	20
56000	01-06	GMC SIERRA 3500	20
56000	07-07	GMC SIERRA 3500 CLASSIC	20
56000	07-19	GMC SIERRA 3500 HD	20
56000	04-24	NISSAN TITAN	20
56000	16-24	NISSAN TITAN XD	20
56000	11-25	RAM 1500	20
56000	19-24	RAM 1500 CLASSIC	20
56000	11-24	RAM 2500	20
56000	11-24	RAM 3500	20
56000	10-24	TOYOTA TUNDRA	20
56001	95-10	DODGE DAKOTA	20
56001	95-08	DODGE RAM 1500	20
56001	95-10	DODGE RAM 2500	20
56001	95-10	DODGE RAM 3500	20
56002	06-12	SUZUKI GRAND VITARA	20
56002	07-11	SUZUKI SX4	20
56003	19-25	CHEVROLET SILVERADO 1500	20
56003	22-22	CHEV. SILVERADO 1500 LTD	20
56003	20-25	CHEV. SILVERADO 2500 HD	20
56003	20-25	CHEV. SILVERADO 3500 HD	20
56003	19-25	GMC SIERRA 1500	20
56003	22-22	GMC SIERRA 1500 LIMITED	20
56003	20-25	GMC SIERRA 2500 HD	20
56003	20-25	GMC SIERRA 3500 HD	12
56008	07-18	ACURA RDX	12
56008	10-11	HONDA ACCORD CROSSTOUR	12
56009	07-13	JEEP GRAND CHEROKEE	12
56010	00-06	MAZDA MPV	12
56011	11-15	HONDA ACCORD	12
56011	06-15	HONDA CIVIC	4
56011	07-13	HONDA FIT	4
56011	04-13	MAZDA 3	4
56011	13-15	MAZDA CX-5	4
56011	09-12	MINI COOPER S	4
56012	07-09	CHEVROLET EQUINOX	4
56012	07-09	PONTIAC TORRENT	4
56012	07-09	SUZUKI XL-7	4
56013	04-07	CHEVROLET MALIBU	12
56013	05-09	PONTIAC G6	12
56014	05-11	CHEVROLET CORVETTE	18
56014	07-11	FORD FOCUS	12
56014	11-11	FORD RANGER	12
56016	11-14	MAZDA 2	12
56016	06-15	MAZDA 5	12
56016	07-15	MAZDA CX-9	12
56018	02-07	SATURN VUE	12
56020	04-14	FORD E-150	12
56020	04-14	FORD E-250	18
56020	04-18	FORD E-350 SUPER DUTY	18
56021	07-12	NISSAN VERSA	18
56022	07-15	NISSAN ALTIMA	18
56022	04-14	NISSAN MAXIMA	18
56022	07-12	NISSAN SENTRA	18
56025	07-10	SATURN OUTLOOK	18
56026	12-12	CHEVROLET CAPTIVA SPORT	18
56026	08-10	SATURN VUE	18
56027	08-12	BUICK ENCLAVE	18
56027	08-12	CHEVROLET MALIBU	12
56027	09-12	CHEVROLET TRAVERSE	12

Part #	Years	Make / Model	Master Pk
56028	08-10	DODGE AVENGER	12
56029	07-11	HONDA ELEMENT	12
56030	04-06	SCION XB	12
56031	97-07	FORD F-150	12
56031	04-04	FORD F-150 HERITAGE	12
56032	03-07	FORD F-250 SUPER DUTY	12
56032	03-07	FORD F-350 SUPER DUTY	12
56033	11-12	INFINITI G25	12
56033	07-08	INFINITI G35	12
56033	09-13	INFINITI G37	18
56033	14-15	INFINITI Q60	12
56033	08-20	NISSAN ROGUE	12
56035	09-10	PONTIAC VIBE	18
56035	11-15	SCION XB	18
56035	09-13	TOYOTA MATRIX	18
56036	03-07	SATURN ION	12
56037	09-09	DODGE JOURNEY	12
56038	07-13	ACURA MDX	12
56039	04-11	MINI COOPER	18
56040	19-24	SUBARU ASCENT	18
56040	16-24	SUBARU CROSSTREK	18
56040	09-25	SUBARU FORESTER	18
56040	10-25	SUBARU OUTBACK	12
56040	13-15	SUBARU XV CROSSTREK	12
56041	09-14	HYUNDAI GENESIS	12
56042	08-19	TOYOTA HIGHLANDER	12
56043	03-07	CADILLAC CTS	12
56044	08-15	CADILLAC CTS	12
56045	05-14	VOLVO XC90	12
56046	06-13	CHEVROLET IMPALA	12
56046	14-16	CHEVROLET IMPALA LIMITED	12
56047	06-11	BUICK LUCERNE	12
56047	14-19	FORD FIESTA	12
56048	06-12	FORD FUSION	12
56049	06-10	HYUNDAI ELANTRA	18
56049	06-14	HYUNDAI SONATA	18
56049	09-09	KIA OPTIMA	18
56051	06-15	HONDA CIVIC	18
56056	07-12	GMC ACADIA	18
56058	07-09	KIA AMANTI	12
56058	11-15	KIA OPTIMA	18
56059	07-16	VOLVO S80	12
56061	08-14	SUBARU IMPREZA	12
56062	08-10	SCION XB	12
56064	11-13	FORD FIESTA	18
56064	09-10	LINCOLN MKS	18
56070	99-18	CHEVROLET SILVERADO 1500	12
56070	07-07	CHEV. SILV. 1500 CLASSIC	12
56070	01-06	CHEV. SILVERADO 1500 HD	12
56070	07-07	CHEV. SILV. 1500 HD CLASSIC	12
56070	19-19	CHEV. SILVERADO 1500 LD	12
56070	99-04	CHEVROLET SILVERADO 2500	12
56070	01-19	CHEV. SILVERADO 2500 HD	12
56070	07-07	CHEV. SILV. 2500 HD CLASSIC	12
56070	01-06	CHEVROLET SILVERADO 3500	12
56070	07-07	CHEV. SILV. 3500 CLASSIC	12
56070	08-19	CHEV. SILVERADO 3500 HD	12
56070	09-10	DODGE RAM 1500	18
56070	10-10	DODGE RAM 2500	12
56070	10-10	DODGE RAM 3500	12
56070	97-14	FORD F-150	12
56070	04-04	FORD F-150 HERITAGE	12
56070	97-99	FORD F-250	12
56070	97-97	FORD F-250 HD	12
56070	99-16	FORD F-250 SUPER DUTY	12
56070	99-24	FORD F-350 SUPER DUTY	12
56070	99-24	FORD F-450 SUPER DUTY	20
56070	99-24	FORD F-550 SUPER DUTY	20
56070	99-18	GMC SIERRA 1500	20
56070	07-07	GMC SIERRA 1500 CLASSIC	20
56070	01-06	GMC SIERRA 1500 HD	20
56070	07-07	GMC SIERRA 1500 HD CLASSIC	20
56070	19-19	GMC SIERRA 1500 LIMITED	20
56070	99-04	GMC SIERRA 2500	20
56070	01-19	GMC SIERRA 2500 HD	20

Part #	Years	Make / Model	Master Pk
56070	07-07	GMC SIERRA 2500 HD CLASSIC	20
56070	01-06	GMC SIERRA 3500	20
56070	07-07	GMC SIERRA 3500 CLASSIC	20
56070	07-19	GMC SIERRA 3500 HD	20
56070	04-24	NISSAN TITAN	20
56070	16-24	NISSAN TITAN XD	20
56070	11-25	RAM 1500	20
56070	19-24	RAM 1500 CLASSIC	20
56070	11-24	RAM 2500	20
56070	11-24	RAM 3500	20
56070	10-24	TOYOTA TUNDRA	20
56071	95-10	DODGE DAKOTA	20
56071	95-08	DODGE RAM 1500	20
56071	95-10	DODGE RAM 2500	20
56071	95-10	DODGE RAM 3500	20
56072	19-25	CHEVROLET SILVERADO 1500	20
56072	22-22	CHEV. SILVERADO 1500 LTD	20
56072	20-25	CHEV. SILVERADO 2500 HD	20
56072	20-25	CHEV. SILVERADO 3500 HD	20
56072	19-25	GMC SIERRA 1500	20
56072	22-22	GMC SIERRA 1500 LIMITED	20
56072	20-25	GMC SIERRA 2500 HD	20
56072	20-25	GMC SIERRA 3500 HD	20
56073	04-07	FORD FREESTAR	20
56073	04-07	MERCURY MONTEREY	20
56074	09-12	INFINITI FX35	20
56074	13-13	INFINITI FX37	20
56074	09-13	INFINITI FX50	20
56074	14-17	INFINITI QX70	20
56076	04-08	PONTIAC GRAND PRIX	20
56077	05-07	BUICK TERRAZA	20
56077	05-09	CHEVROLET UPLANDER	12
56077	05-06	PONTIAC MONTANA	12
56077	05-07	SATURN RELAY	12
56078	07-12	HYUNDAI SANTA FE	12
56078	10-13	KIA FORTE	12
56079	11-12	TOYOTA AVALON	12
56079	07-11	TOYOTA CAMRY	12
56079	09-16	TOYOTA VENZA	12
56082	06-15	MAZDA MX-5 MIATA	12
56083	10-23	LEXUS RX350	12
56083	18-22	LEXUS RX350L	12
56083	10-23	LEXUS RX450H	12
56088	10-23	FORD MUSTANG	18
56090	10-13	FORD TRANSIT CONNECT	18
56091	10-14	SUBARU LEGACY	12
56093	11-24	FORD EXPLORER	12
56093	10-19	FORD TAURUS	12
56093	13-16	LINCOLN MKS	12
56094	10-17	CHEVROLET EQUINOX	18
56094	10-17	GMC TERRAIN	18
56095	10-19	LINCOLN MKT	18
56096	10-16	CADILLAC SRX	18
56098	10-16	BUICK LACROSSE	18
56099	11-17	LEXUS CT200H	12
56099	10-12	LEXUS HS250H	12
56102	07-13	MINI COOPER	12
56103	10-11	SUZUKI KIZASHI	12
56104	09-09	KIA BORREGO	12
56106	11-20	TOYOTA SIENNA	12
56107	04-07	TOYOTA HIGHLANDER	12
56109	10-20	DODGE JOURNEY	12
56110	10-19	FORD F-150	12
56111	08-12	SUBARU IMPREZA	12
56114	11-13	FORD FIESTA	12
56116	00-05	CHEVROLET IMPALA	12
56117	10-10	INFINITI G37	12
56120	11-14	FORD EDGE	12
56121	11-15	LINCOLN MKX	12
56124	11-17	NISSAN JUKE	12
56126	11-16	HYUNDAI ELANTRA	12
56127	10-17	MINI COOPER	12
56127	11-19	MINI COOPER	12
56127	11-12	MINI COOPER	18
56133	11-13	DODGE DURANGO	18

Part #	Years	Make / Model	Master Pk	Part #	Years	Make / Model	Master Pk	Part #	Years	Make / Model	Master Pk
56135	11-14	DODGE CHARGER	12	56226	09-12	SUZUKI EQUATOR	12	56309	16-16	SCION IM	12
56136	08-14	SCION XD	18	56227	11-24	NISSAN LEAF	18	56309	19-23	TOYOTA COROLLA	12
56138	12-18	FORD FOCUS	12	56228	14-18	KIA FORTE5	18	56309	17-18	TOYOTA COROLLA IM	9
56140	12-14	FORD FOCUS	12	56230	15-23	DODGE CHALLENGER	12	56310	16-16	MAZDA CX-5	9
56141	11-11	NISSAN PATHFINDER	12	56231	04-08	ACURA TL	12	56311	16-16	SCION IA	12
56142	09-14	LEXUS IS F	12	56233	17-20	HYUNDAI ELANTRA	12	56311	17-18	TOYOTA YARIS IA	12
56142	16-16	LEXUS IS200T	12	56233	14-18	HYUNDAI ELANTRA GT	12	56313	16-24	CHEVROLET MALIBU	12
56142	09-15	LEXUS IS250	12	56233	17-22	HYUNDAI IONIQ	12	56314	11-20	KIA OPTIMA	12
56142	16-16	LEXUS IS300	12	56234	15-23	DODGE CHARGER	12	56315	16-19	CHEVROLET VOLT	12
56142	09-16	LEXUS IS350	12	56235	15-23	CHRYSLER 300	12	56316	17-18	HYUNDAI ELANTRA	12
56145	11-14	CHRYSLER 300	18	56241	11-15	HYUNDAI SONATA	12	56319	16-19	CHEVROLET CRUZE	12
56147	04-15	TOYOTA PRIUS	18	56242	15-17	CHRYSLER 200	12	56320	17-18	FORD ESCAPE	12
56148	12-21	NISSAN NV1500	12	56243	16-16	SUBARU CROSSTREK	12	56321	17-22	KIA SPORTAGE	12
56148	12-21	NISSAN NV2500	18	56243	14-15	SUBARU XV CROSSTREK	12	56322	17-20	CHRYSLER PACIFICA	12
56148	12-21	NISSAN NV3500	18	56245	13-17	BUICK ENCLAVE	12	56323	16-18	CADILLAC CT6	12
56149	12-17	HYUNDAI ACCENT	12	56245	13-17	CHEVROLET TRAVERSE	12	56324	16-19	HONDA CIVIC	18
56153	12-17	HYUNDAI VELOSTER	12	56245	13-16	GMC ACADIA	12	56325	21-24	BUICK ENVISION	18
56156	12-17	TOYOTA PRIUS V	12	56245	17-17	GMC ACADIA LIMITED	12	56325	17-25	CADILLAC XT5	12
56157	12-17	KIA RIO	12	56246	15-19	SUBARU LEGACY	12	56325	20-25	CADILLAC XT6	12
56158	12-16	HONDA CR-V	12	56247	15-17	HYUNDAI SONATA	12	56325	19-25	CHEVROLET BLAZER	12
56159	12-14	LAND ROV. RANGE ROV.EVOQUE	12	56248	14-24	INFINITI Q50	12	56325	17-23	GMC ACADIA	12
56161	05-10	HONDA ODYSSEY	12	56251	11-16	KIA SPORTAGE	12	56326	17-25	CADILLAC XT5	12
56165	06-12	TOYOTA RAV4	12	56254	13-17	HYUNDAI ACCENT	12	56326	20-25	CADILLAC XT6	12
56170	12-15	HONDA PILOT	12	56256	14-18	KIA SORENTO	12	56326	19-25	CHEVROLET BLAZER	12
56172	11-19	FORD EXPLORER	18	56257	12-15	CHEVROLET CAPTIVA SPORT	12	56326	17-23	GMC ACADIA	12
56172	13-18	FORD POLICE INTER. UTILITY	12	56258	13-20	LINCOLN MKZ	12	56327	22-24	FORD E-TRANSIT	12
56173	13-17	HONDA ACCORD	12	56259	12-16	SUBARU IMPREZA	12	56327	15-24	FORD TRANSIT-150	12
56174	12-19	FIAT 500	12	56259	15-21	SUBARU WRX	12	56327	15-24	FORD TRANSIT-250	12
56176	13-15	CHEVROLET MALIBU	12	56259	15-21	SUBARU WRX STI	9	56327	15-24	FORD TRANSIT-350	12
56176	16-16	CHEVROLET MALIBU LIMITED	12	56261	15-20	TOYOTA SIENNA	9	56328	11-13	KIA SORENTO	9
56179	13-16	DODGE DART	18	56262	15-19	LINCOLN MKC	9	56329	07-10	FORD EDGE	9
56180	13-19	CADILLAC ATS	12	56264	17-17	GENESIS G80	9	56329	08-12	FORD ESCAPE	12
56181	13-17	CHEVROLET TRAVERSE	12	56264	15-16	HYUNDAI GENESIS	12	56329	04-07	FORD FREESTAR	12
56184	13-18	HYUNDAI SANTA FE	12	56267	15-24	NISSAN MURANO	12	56329	07-10	LINCOLN MKX	12
56184	13-18	HYUNDAI SANTA FE SPORT	12	56268	15-17	LEXUS NX200T	12	56329	08-11	MAZDA TRIBUTE	12
56184	09-09	KIA BORREGO	12	56268	15-21	LEXUS NX300H	12	56329	05-11	MERCURY MARINER	12
56185	14-18	NISSAN VERSA	12	56269	13-22	ACURA ILX	12	56330	11-20	DODGE JOURNEY	12
56188	14-20	CHEVROLET IMPALA	12	56270	15-22	RAM PROMASTER CITY	12	56331	11-16	CHRYSLER TOWN & COUNTRY	12
56189	14-20	MITSUBISHI OUTLANDER	12	56272	15-18	FORD EDGE	12	56331	11-20	DODGE GRAND CARAVAN	12
56191	14-19	FORD FIESTA	12	56273	15-18	FORD FOCUS	12	56331	12-15	RAM C/V	12
56192	14-20	ACURA MDX	12	56274	15-23	JEEP RENEGADE	12	56332	13-18	HYUNDAI SANTA FE	12
56193	14-17	FIAT 500L	12	56275	12-19	TOYOTA PRIUS C	12	56332	19-19	HYUNDAI SANTA FE XL	12
56197	14-15	CHEVROLET CAMARO	12	56278	11-15	FORD EXPLORER	12	56332	07-12	HYUNDAI VERACRUZ	12
56205	13-19	NISSAN SENTRA	12	56279	15-18	CHEVROLET CITY EXPRESS	12	56332	15-21	KIA SEDONA	12
56206	14-19	NISSAN VERSA NOTE	12	56279	13-21	NISSAN NV200	12	56332	07-20	KIA SORENTO	12
56207	14-19	CADILLAC CTS	12	56280	14-17	MAZDA 6	18	56333	08-10	CHRYSLER TOWN & COUNTRY	12
56208	14-18	JEEP CHEROKEE	18	56281	14-21	INFINITI QX60	18	56333	08-12	DODGE CALIBER	12
56210	10-17	CHEVROLET EQUINOX	12	56281	13-20	NISSAN PATHFINDER	18	56333	11-13	DODGE DURANGO	12
56210	10-17	GMC TERRAIN	12	56283	16-16	HYUNDAI ELANTRA	18	56333	08-10	DODGE GRAND CARAVAN	12
56211	11-14	CHRYSLER 200	12	56284	16-22	HONDA HR-V	12	56333	08-17	JEEP PATRIOT	12
56211	11-14	DODGE AVENGER	12	56285	17-24	VOLVO S90	12	56334	07-12	DODGE NITRO	18
56212	13-16	SCION FR-S	12	56285	16-24	VOLVO XC90	12	56334	08-12	JEEP LIBERTY	18
56212	13-20	SUBARU BRZ	12	56287	15-18	VOLVO V60	12	56335	13-16	FORD ESCAPE	18
56212	17-23	SUBARU IMPREZA	12	56287	15-18	VOLVO V60 CROSS COUNTRY	12	56336	14-25	DODGE DURANGO	18
56214	11-15	CHEVROLET CRUZE	12	56288	12-17	BUICK VERANO	12	56338	16-23	MAZDA CX-9	18
56214	16-16	CHEVROLET CRUZE LIMITED	12	56291	19-25	HONDA PASSPORT	12	56339	16-24	NISSAN ALTIMA	5
56215	13-15	HONDA CROSSTOUR	12	56291	16-22	HONDA PILOT	12	56340	05-09	BUICK LACROSSE	5
56216	13-16	BUICK ENCORE	12	56292	15-18	FORD EDGE	12	56341	01-05	HONDA CIVIC	5
56217	08-19	TOYOTA HIGHLANDER	12	56293	15-22	LAND ROVER RANGE ROVER	12	56342	11-17	NISSAN QUEST	5
56218	14-24	FORD TRANSIT CONNECT	12	56293	15-22	LAND ROV. RANGE ROV. SPORT	12	56343	09-19	FORD FLEX	12
56220	07-12	KIA RONDO	12	56294	16-23	NISSAN MAXIMA	12	56344	11-17	JEEP COMPASS	12
56220	10-19	KIA SOUL	12	56295	12-16	KIA RIO	12	56345	05-07	FORD ESCAPE	12
56222	07-12	KIA RONDO	12	56296	18-24	MITSUBISHI ECLIPSE CROSS	12	56345	05-06	MAZDA TRIBUTE	12
56222	10-19	KIA SOUL	12	56296	16-20	MITSUBISHI OUTLANDER	12	56346	07-12	HYUNDAI SANTA FE	12
56223	14-24	MITSUBISHI MIRAGE	12	56297	15-19	LAND ROV. DISCOVERY SPORT	12	56347	07-10	HYUNDAI ENTOURAGE	12
56223	17-24	MITSUBISHI MIRAGE G4	12	56298	16-18	LINCOLN MKX	12	56347	06-14	KIA SEDONA	12
56224	11-20	VOLVO S60	12	56299	16-17	HONDA ACCORD	12	56348	10-18	HYUNDAI TUCSON	12
56224	16-18	VOLVO S60 CROSS COUNTRY	12	56300	18-21	MAZDA 6	12	56349	16-23	TOYOTA TACOMA	12
56225	05-24	NISSAN FRONTIER	12	56300	16-21	MAZDA CX-3	12	56350	21-23	LEXUS ES250	12
56225	05-12	NISSAN PATHFINDER	12	56300	16-24	MAZDA MX-5 MIATA	12	56350	22-23	LEXUS ES300H	12
56225	05-15	NISSAN XTERRA	12	56301	16-17	HONDA ACCORD	12	56350	19-23	LEXUS ES350	12
56225	09-12	SUZUKI EQUATOR	12	56303	12-16	CHEVROLET SONIC	12	56350	13-18	TOYOTA AVALON	12
56226	05-24	NISSAN FRONTIER	12	56306	11-19	FORD EXPLORER	12	56350	13-18	TOYOTA RAV4	12
56226	05-12	NISSAN PATHFINDER	12	56306	13-18	FORD POLICE INTER. UTILITY	9	56351	13-20	FORD FUSION	12
56226	09-13	NISSAN XTERRA	12	56308	16-18	FIAT 500X	12	56353	16-18	TOYOTA PRIUS	12

Part #	Years	Make / Model	Master Pk
56354	17-19	CHEVROLET CRUZE	12
56355	10-17	VOLVO XC60	12
56355	21-24	VOLVO XC40	12
56355	21-24	VOLVO XC40 RECHARGE	12
56357	14-21	INFINITI QX60	12
56357	13-20	NISSAN PATHFINDER	12
56362	16-17	HYUNDAI SONATA	12
56363	17-22	BUICK ENCORE	12
56364	16-20	BUICK ENVISION	12
56365	09-11	HONDA PILOT	12
56365	17-25	HONDA RIDGELINE	12
56366	09-11	HONDA PILOT	12
56366	17-25	HONDA RIDGELINE	12
56367	17-24	SUBARU IMPREZA	12
56368	12-16	SUBARU IMPREZA	18
56369	17-21	JEEP COMPASS	12
56370	17-25	HONDA CR-V	12
56371	17-22	TOYOTA PRIUS PRIME	12
56374	15-17	VOLKSWAGEN GOLF R	12
56374	12-15	VOLKSWAGEN PASSAT	12
56375	18-18	CHEVROLET EQUINOX	12
56375	18-18	GMC TERRAIN	12
56376	17-22	KIA NIRO	12
56377	17-21	MAZDA CX-5	12
56378	11-17	HONDA ODYSSEY	12
56380	12-19	VOLKSWAGEN BEETLE	12
56381	17-22	HYUNDAI IONIQ	12
56382	18-25	HONDA ODYSSEY	12
56383	18-20	VOLKSWAGEN ATLAS	12
56384	18-22	TOYOTA C-HR	12
56385	15-20	TOYOTA YARIS	12
56386	08-16	VOLVO XC70	18
56387	16-24	CHEVROLET MALIBU	12
56388	16-18	VOLKSWAGEN PASSAT	12
56389	18-20	BUICK REGAL SPORTBACK	5
56389	18-20	BUICK REGAL TOURX	5
56390	18-19	HYUNDAI SONATA	12
56391	17-17	VOLKSWAGEN GOLF ALLTRACK	12
56393	18-24	BUICK ENCLAVE	18
56393	18-23	CHEVROLET TRAVERSE	12
56394	18-24	BUICK ENCLAVE	12
56394	18-23	CHEVROLET TRAVERSE	12
56395	15-20	HONDA FIT	12
56396	16-21	HONDA CIVIC	12
56397	17-19	NISSAN ROGUE SPORT	12
56399	17-20	CHRYSLER PACIFICA	18
56399	20-24	CHRYSLER VOYAGER	12
56400	14-19	NISSAN VERSA	12
56401	18-20	NISSAN PATHFINDER	12
56402	18-22	HONDA ACCORD	12
56403	18-24	VOLKSWAGEN TIGUAN	12
56404	13-17	AUDI Q5	18
56404	14-17	AUDI SQ5	18
56405	18-19	VOLKSWAGEN GOLF R	18
56405	18-20	VOLKSWAGEN GTI	12
56406	19-23	JEEP CHEROKEE	12
56407	20-24	JEEP GLADIATOR	12
56407	18-24	JEEP WRANGLER	12
56408	14-18	KIA FORTE5	12
56409	18-21	HYUNDAI KONA	12
56409	19-21	HYUNDAI KONA ELECTRIC	12
56410	14-18	KIA FORTE	18
56410	14-17	KIA FORTE KOUP	18
56412	18-22	MINI COOPER S	18
56412	18-22	MITSUBISHI OUTLANDER PHEV	18
56413	15-20	FORD F-150	12
56416	19-22	TOYOTA AVALON	18
56417	18-24	TOYOTA CAMRY	12
56418	18-24	NISSAN KICKS	12
56419	19-22	CHEVROLET TRAX	12
56420	20-22	HYUNDAI PALISADE	12
56420	22-24	HYUNDAI SANTA CRUZ	5
56420	19-23	HYUNDAI SANTA FE	5
56420	22-24	HYUNDAI TUCSON	5
56420	22-24	KIA CARNIVAL	5
56420	23-23	KIA SORENTO	18

Part #	Years	Make / Model	Master Pk
56420	20-22	KIA TELLURIDE	18
56421	19-25	HONDA PASSPORT	12
56421	16-22	HONDA PILOT	12
56422	12-17	VOLKSWAGEN TIGUAN	12
56423	98-98	MERCURY VILLAGER	12
56423	98-03	NISSAN FRONTIER	5
56423	98-02	NISSAN QUEST	12
56425	06-07	NISSAN MURANO	12
56426	14-21	JEEP GRAND CHEROKEE	12
56426	22-22	JEEP GRAND CHEROKEE WK	12
56427	19-25	CADILLAC XT4	12
56427	23-24	CADILLAC LYRIQ	12
56427	24-24	CHEVROLET BLAZER EV	12
56427	24-24	CHEVROLET EQUINOX EV	12
56427	24-24	HONDA PROLOGUE	12
56429	18-24	CHEVROLET EQUINOX	12
56429	18-24	GMC TERRAIN	12
56430	13-21	LEXUS ES300H	12
56430	13-18	LEXUS ES350	12
56431	19-23	FORD RANGER	5
56432	19-19	FORD ESCAPE	12
56434	23-24	MITSUBISHI OUTLANDER PHEV	12
56434	19-24	TOYOTA RAV4	12
56434	21-24	TOYOTA RAV4 PRIME	12
56435	19-24	MAZDA 3	12
56436	19-24	FORD EDGE	12
56437	19-24	FORD EDGE	12
56438	01-02	TOYOTA TUNDR	12
56439	19-22	TOYOTA PRIUS AWD-E	12
56440	16-19	VOLKSWAGEN PASSAT	12
56442	19-21	HYUNDAI TUCSON	12
56442	19-21	HYUNDAI VELOSTER	12
56442	21-24	KIA SELTOS	12
56442	20-24	KIA SOUL	12
56443	20-24	FORD F-250 SUPER DUTY	12
56443	20-24	FORD F-350 SUPER DUTY	12
56443	20-24	FORD F-450 SUPER DUTY	12
56443	20-24	FORD F-550 SUPER DUTY	12
56443	20-24	FORD F-650	12
56444	20-25	SUBARU LEGACY	12
56445	20-22	NISSAN ROGUE SPORT	18
56446	19-23	LINCOLN NAUTILUS	12
56448	20-22	FORD ESCAPE	12
56450	20-24	MAZDA CX-30	12
56451	20-24	HYUNDAI VENUE	12
56452	20-21	TOYOTA HIGHLANDER	5
56453	20-25	LINCOLN AVIATOR	12
56454	20-24	TOYOTA COROLLA	12
56456	20-24	BUICK ENCORE GX	12
56457	19-24	KIA FORTE	12
56459	21-24	NISSAN ROGUE	12
56460	21-24	TOYOTA VENZA	12
56461	20-23	HYUNDAI SONATA	12
56462	21-24	FORD BRONCO SPORT	12
56464	21-24	VOLKSWAGEN ATLAS	12
56464	20-24	VOLK. ATLAS CROSS SPORT	12
56465	21-23	FORD F-150	12
56466	20-22	HYUNDAI PALISADE	12
56466	22-24	HYUNDAI SANTA CRUZ	12
56466	19-23	HYUNDAI SANTA FE	12
56466	22-24	HYUNDAI TUCSON	12
56466	22-24	KIA CARNIVAL	12
56466	23-23	KIA SORENTO	12
56466	20-22	KIA TELLURIDE	12
56467	22-24	MITSUBISHI OUTLANDER	12
56468	21-24	FORD BRONCO	12
56469	21-24	KIA K5	12
56470	21-24	HYUNDAI ELANTRA	12
56471	21-24	FORD BRONCO	12
56472	22-24	JEEP COMPASS	12
56473	22-24	JEEP GRAND CHEROKEE	12
56473	21-24	JEEP GRAND CHEROKEE L	12
56474	21-24	KIA SORENTO	12
56474	23-24	KIA SPORTAGE	12
56477	22-24	FORD MAVERICK	12

Part #	Years	Make / Model	Master Pk
56478	14-24	RAM PROMASTER 1500	12
56478	14-24	RAM PROMASTER 2500	12
56478	14-24	RAM PROMASTER 3500	12
56479	22-24	TOYOTA COROLLA CROSS	12
56480	20-24	TOYOTA HIGHLANDER	12
56481	21-23	FORD F-150	12
56482	20-24	MINI COOPER S	12
56483	23-25	HONDA HR-V	12
56484	22-24	HYUNDAI IONIQ 5	5
56486	21-23	FORD F-150	5
56487	22-25	MAZDA CX-5	5
56487	23-24	MAZDA CX-50	5
56488	20-24	BUICK ENCORE GX	5
56489	21-24	TOYOTA SIENNA	12
56490	23-24	KIA TELLURIDE	12
56491	23-24	HYUNDAI PALISADE	12
56492	21-24	CHRYSLER PACIFICA	12
56493	20-24	TOYOTA CAMRY	12
56494	24-25	MAZDA CX-90	12
56494	25-25	MAZDA CX-70	12
56498	23-24	DODGE HORNET	12
56499	22-24	KIA EV6	12
56500	20-24	NISSAN SENTRA	12
56501	23-24	KIA TELLURIDE	12
56503	23-24	FORD ESCAPE	12
56504	22-23	HYUNDAI KONA	12
56504	22-23	HYUNDAI KONA N	12
56504	22-23	HYUNDAI KONA ELECTRIC	12
56505	23-24	KIA NIRO	12
56506	19-24	LEXUS UX250H	12
56507	23-24	FORD ESCAPE	12
56508	22-25	HONDA CIVIC	12
56509	19-22	ACURA RDX	12
56510	04-12	CHEVROLET COLORADO	12
56510	04-12	GMC CANYON	12
56510	06-06	ISUZU I-280	12
56510	07-08	ISUZU I-290	12
56510	06-06	ISUZU I-350	12
56510	07-08	ISUZU I-370	12
56511	23-24	NISSAN ARIYA	12
56513	08-12	TOYOTA HILUX	12
56513	93-98	TOYOTA T100	12
56513	05-15	TOYOTA TACOMA	12
56514	24-24	CHEVROLET TRAX	12
56516	22-24	SUBARU WRX	12
56517	18-22	TOYOTA C-HR	12
56517	22-24	TOYOTA COROLLA CROSS	12
56518	23-25	HONDA PILOT	12
56519	23-25	HONDA PILOT	12
56520	22-24	INFINITI QX60	12
56520	22-24	NISSAN PATHFINDER	12
56521	22-23	CHEVROLET BOLT EUV	18
56522	24-25	BUICK ENVIETA	18
56523	19-24	VOLKSWAGEN JETTA	18
56524	24-24	LEXUS TX350	18
56524	24-24	LEXUS TX500H	12
56524	24-24	LEXUS TX550H+	12
56524	20-24	TOYOTA HIGHLANDER	12
56524	24-24	TOYOTA GRAND HIGHLANDER	12
56525	15-20	ACURA TLX	12
56526	24-24	KIA EV9	12
56527	22-24	VOLKSWAGEN GOLF R	12
56527	22-24	VOLKSWAGEN GTI	12
56528	21-24	ACURA TLX	12
56529	24-24	HYUNDAI SONATA	12
56530	21-24	KIA SORENTO	12
56532	20-24	TESLA Y	12
56536	23-24	TOYOTA CROWN	12
56537	25-25	BUICK ENCLAVE	12
56537	24-24	CHEVROLET TRAVERSE	12
56537	24-24	GMC ACADIA	12
56538	25-25	BUICK ENCLAVE	12
56538	24-24	CHEVROLET TRAVERSE	12
56538	24-24	GMC ACADIA	12
56542	24-25	BUICK ENVIETA	12

Part #	Years	Make / Model	Master Pk
56594	10-17	CHEVROLET EQUINOX	12
56594	10-17	GMC TERRAIN	12
56673	04-07	FORD FREESTAR	12
56673	04-07	MERCURY MONTEREY	12
57000	05-12	NISSAN ARMADA	12
57000	04-15	NISSAN TITAN	12
57008	15-24	FORD F-150	12
57008	17-24	FORD F-250 SUPER DUTY	12
57008	17-24	FORD F-350 SUPER DUTY	12
57008	17-24	FORD F-450 SUPER DUTY	12
57010	15-24	FORD F-150	12
57010	17-24	FORD F-250 SUPER DUTY	12
57010	17-24	FORD F-350 SUPER DUTY	12
57010	17-24	FORD F-450 SUPER DUTY	12
58265	20-21	CHEVROLET SILVERADO 1500	12
58265	20-21	CHEV. SILVERADO 2500 HD	12
58265	20-21	CHEV. SILVERADO 3500 HD	12
58265	20-21	GMC SIERRA 1500	12
58265	20-21	GMC SIERRA 2500 HD	12
58265	20-21	GMC SIERRA 3500 HD	12
58266	20-21	CHEVROLET SILVERADO 1500	12
58266	20-21	CHEV. SILVERADO 2500 HD	12
58266	20-21	CHEV.SILVERADO 3500 HD	12
58266	20-21	GMC SIERRA 1500	12
58266	20-21	GMC SIERRA 2500 HD	12
58266	20-21	GMC SIERRA 3500 HD	12
58435	12-13	BUICK ENCLAVE	12
58435	12-15	CHEVROLET CAPTIVA SPORT	12
58435	06-10	CHEVROLET COBALT	12
58435	11-19	CHEVROLET CRUZE	12
58435	10-17	CHEVROLET EQUINOX	12
58435	06-11	CHEVROLET HHR	12
58435	16-18	CHEVROLET MALIBU	12
58435	12-20	CHEVROLET SONIC	12
58435	13-15	CHEVROLET SPARK	12
58435	12-19	CHEVROLET TRAVERSE	12
58435	05-05	DODGE DAKOTA	12
58435	06-20	FORD FUSION	12
58435	12-13	GMC ACADIA	12
58435	10-17	GMC TERRAIN	12
58435	15-16	HONDA FIT	12
58435	17-17	HONDA HR-V	12
58435	14-19	JEEP CHEROKEE	12
58445	10-11	CADILLAC SRX	12
58445	08-08	CHEVROLET EQUINOX	12
58445	14-15	CHEVROLET MALIBU	12
58445	03-03	CHEVROLET TRACKER	12
58445	07-20	FORD EDGE	12
58445	01-20	FORD ESCAPE	12
58445	07-11	FORD EXPLORER	12
58445	09-19	FORD FLEX	12
58445	06-20	FORD FUSION	12
58445	03-03	GMC SAFARI	12
58445	97-14	HONDA CR-V	12
58445	09-14	HONDA FIT	12
58445	09-12	HONDA PILOT	12
58445	98-98	JEEP WRANGLER	12
58445	09-09	LEXUS RX350	12
58445	05-10	PONTIAC G6	12
58445	07-09	SATURN AURA	12
58445	08-10	SATURN VUE	12
58445	08-08	SUBARU LEGACY	12
58455	16-20	BUICK ENVISION	12
58455	10-11	CADILLAC SRX	12
58455	13-19	CHEVROLET CRUZE	12
58455	06-18	CHEVROLET MALIBU	12
58455	14-14	CHEVROLET ORLANDO	12
58455	18-20	CHEVROLET SONIC	12
58455	12-14	HONDA CR-V	12
58455	15-16	HONDA FIT	12
58455	17-17	HONDA HR-V	12
58455	01-04	OLDSMOBILE ALERO	12
58475	13-17	BUICK ENCLAVE	12
58475	12-17	CHEVROLET TRAVERSE	12
58475	13-16	GMC ACADIA	12

Part #	Years	Make / Model	Master Pk
58475	17-17	GMC ACADIA LIMITED	12
58900	10-17	CHEVROLET EQUINOX	12
58900	10-17	GMC TERRAIN	12
58901	07-11	HONDA CR-V	12
58902	98-06	JEEP WRANGLER	12
58903	07-18	JEEP WRANGLER	12
58904	12-16	HONDA CR-V	12
58905	12-14	FORD FOCUS	12
58906	13-18	RAM 1500	12
58906	19-24	RAM 1500 CLASSIC	12
58907	14-21	JEEP GRAND CHEROKEE	12
58907	22-22	JEEP GRAND CHEROKEE WK	12
58908	13-17	BUICK ENCLAVE	12
58908	13-16	GMC ACADIA	12
58908	17-17	GMC ACADIA LIMITED	12
58909	14-18	JEEP CHEROKEE	12
58910	15-22	CHEVROLET COLORADO	12
58910	15-22	GMC CANYON	12
58911	12-19	FIAT 500	12
58912	09-14	FORD F-150	12
58913	06-12	TOYOTA RAV4	12
58914	11-14	FORD EDGE	12
58915	99-04	JEEP GRAND CHEROKEE	12
58916	09-10	DODGE RAM 1500	12
58916	11-18	RAM 1500	12
58916	19-24	RAM 1500 CLASSIC	12
58917	02-07	JEEP LIBERTY	12
58922	13-17	CHEVROLET TRAVERSE	12
58924	07-13	CHEVROLET AVALANCHE	12
58925	04-07	BUICK RAINIER	12
58925	02-08	CHEVROLET TRAILBLAZER	12
58925	02-09	GMC ENVOY	12
58925	02-04	OLDSMOBILE BRAVADA	12
58926	04-12	CHEVROLET COLORADO	12
58926	04-12	GMC CANYON	12
58926	06-06	ISUZU I-280	12
58926	07-08	ISUZU I-290	12
58926	06-06	ISUZU I-350	12
58926	07-08	ISUZU I-370	12
58927	07-14	CADILLAC ESCALADE	12
58927	07-14	CHEVROLET SUBURBAN 1500	12
58927	07-14	CHEVROLET TAHOE	12
58927	07-14	GMC YUKON	12
58927	07-14	GMC YUKON XL 1500	12
58928	02-07	SATURN VUE	12
58929	05-10	CHEVROLET COBALT	12
58929	06-11	CHEVROLET HHR	12
58929	07-10	PONTIAC G5	12
58929	05-06	PONTIAC PURSUIT	12
58931	05-10	CHEVROLET COBALT	12
58931	07-10	PONTIAC G5	12
58931	05-06	PONTIAC PURSUIT	12
58932	08-12	BUICK ENCLAVE	12
58932	08-12	CHEVROLET MALIBU	12
58932	09-12	CHEVROLET TRAVERSE	12
58933	12-12	CHEVROLET CAPTIVA SPORT	1
58933	08-10	SATURN VUE	1
58934	13-15	CHEVROLET MALIBU	12
58934	16-16	CHEVROLET MALIBU LIMITED	12
58935	11-15	CHEVROLET CRUZE	12
58935	16-16	CHEVROLET CRUZE LIMITED	12
58936	12-16	CHEVROLET SONIC	12
58937	07-12	DODGE NITRO	12
58937	08-12	JEEP LIBERTY	12
58938	11-16	JEEP COMPASS	12
58939	05-06	JEEP GRAND CHEROKEE	1
58940	07-13	JEEP GRAND CHEROKEE	12
58941	09-19	FORD FLEX	12
58942	06-12	FORD FUSION	1
58943	13-16	FORD ESCAPE	12
58944	12-18	FORD FOCUS	12
58945	13-20	FORD FUSION	12
58946	11-13	FORD FIESTA	12
58947	07-11	HONDA ELEMENT	1
58948	07-13	HONDA FIT	12

Part #	Years	Make / Model	Master Pk
58949	02-06	HONDA CR-V	12
58950	06-12	SUZUKI GRAND VITARA	1
58950	07-11	SUZUKI SX4	1
58952	07-10	FORD EDGE	12
58952	05-12	FORD ESCAPE	12
58952	04-07	FORD FREESTAR	12
58952	07-10	LINCOLN MKX	12
58952	08-11	MAZDA TRIBUTE	12
58952	05-11	MERCURY MARINER	12
58954	17-21	FORD ESCAPE	12
58955	16-18	ACURA MDX	12
58956	13-18	TOYOTA RAV4	12
58957	14-25	DODGE DURANGO	1
58958	17-21	JEEP COMPASS	12
58959	08-12	DODGE CALIBER	1
58959	11-13	DODGE DURANGO	1
58959	08-17	JEEP PATRIOT	1
58960	10-19	LINCOLN MKT	12
58962	13-15	SUBARU XV CROSSTREK	12
58963	19-23	JEEP CHEROKEE	12
58964	20-24	JEEP GLADIATOR	12
58964	18-24	JEEP WRANGLER	12
58965	15-20	CADILLAC ESCALADE	12
58965	15-20	GMC YUKON	12
58965	15-20	GMC YUKON XL	12
58966	15-20	CHEVROLET SUBURBAN	12
58966	15-20	CHEVROLET TAHOE	12
58967	16-18	CHEVROLET SILVERADO 1500	12
58967	19-19	CHEV. SILVERADO 1500 LD	12
58967	16-19	CHEV. SILVERADO 2500 HD	12
58967	16-19	CHEV. SILVERADO 3500 HD	12
58967	16-18	GMC SIERRA 1500	12
58967	19-19	GMC SIERRA 1500 LIMITED	12
58967	16-19	GMC SIERRA 2500 HD	12
58967	16-19	GMC SIERRA 3500 HD	12
58968	16-20	BUICK ENVISION	1
58970	15-18	FORD F-150	12
58971	18-21	CHEVROLET EQUINOX	12
58972	14-19	FORD FIESTA	1
58973	17-19	GMC ACADIA	1
58974	18-21	CHEVROLET EQUINOX	12
58975	19-24	RAM 1500	1
58976	16-19	FORD EXPLORER	12
58977	14-19	FORD FIESTA	1
58978	10-16	CADILLAC SRX	1
58983	20-25	LINCOLN AVIATOR	1
58984	19-25	CHEVROLET SILVERADO 1500	1
58984	22-22	CHEV. SILVERADO 1500 LTD	1
58984	20-23	CHEV. SILVERADO 2500 HD	1
58984	20-23	CHEV. SILVERADO 3500 HD	1
58984	19-25	GMC SIERRA 1500	1
58984	22-22	GMC SIERRA 1500 LIMITED	1
58984	20-23	GMC SIERRA 2500 HD	1
58984	20-23	GMC SIERRA 3500 HD	1
58985	21-24	CHEVROLET SUBURBAN	1
58985	21-24	CHEVROLET TAHOE	1
58985	21-24	GMC YUKON	1
58985	21-24	GMC YUKON XL	1
58986	19-24	FORD RANGER	1
58987	17-22	FORD F-250 SUPER DUTY	1
58987	17-22	FORD F-350 SUPER DUTY	1
58988	22-24	CHEVROLET EQUINOX	1
58988	07-17	FORD EXPEDITION	1
58989	21-23	FORD F-150	1
58992	21-24	FORD BRONCO	1
58993	21-24	CADILLAC ESCALADE	12
58993	21-24	CADILLAC ESCALADE ESV	12
58994	13-18	RAM 2500	1
58994	13-18	RAM 3500	1
58995	19-24	RAM 2500	1
58995	19-24	RAM 3500	1
58996	21-24	FORD BRONCO	1
58997	22-24	JEEP COMPASS	1
58998	22-24	JEEP GRAND CHEROKEE	1
58998	21-24	JEEP GRAND CHEROKEE L	1



LIMITED LIFETIME WARRANTY

CURT provides limited lifetime warranty coverage against defects in factory workmanship and materials for CURT products ("Products") sold by factory authorized dealers for use by retail (end use) consumers. This Limited Warranty is provided only to the original Product consumer, and applies only to the original installation. This Limited Warranty is not transferrable and does not extend or apply to anyone else. For consumers in the U.S.: this Limited Warranty gives you specific legal rights; you also may have other rights, which vary from state to state.

This Limited Warranty is the sole and exclusive warranty provided by CURT, and all other warranties and conditions are excluded and disclaimed. **UNDER THE LAW OF CERTAIN STATES, THERE MAY BE NO IMPLIED CONDITIONS OR WARRANTIES FROM CURT APPLICABLE TO YOUR PRODUCT, AND ALL IMPLIED CONDITIONS OR WARRANTIES (INCLUDING ANY WARRANTY OF MERCHANTABILITY OR FITNESS FOR A PARTICULAR PURPOSE) ARE EXCLUDED AND DISCLAIMED WHERE ALLOWED BY LAW.** If implied warranties are imposed under any applicable state law, all such implied warranties are limited to the duration of the applicable provisions of this Limited Warranty. For consumers in the U.S.: some states do not allow limitations on how long an implied warranty lasts, so the above limitation may not apply to you.

COVERED PRODUCTS AND LIMITATIONS

CURT provides the following Limited Warranty coverage:

Product	Workmanship & Materials	Components & Parts	Finishings & Coatings
Hitches	Lifetime	1-year	1-year
Brake controllers	Lifetime	1-year	1-year
Electrical and wiring	1-year	1-year	1-year
Other accessories	Lifetime	1-year	1-year

Each of the warranty coverage periods runs from the date of purchase of the Product (proof of purchase is required) and applies only to warranted defects that first occur and are reported to CURT within the applicable warranty period. CURT retains the right to determine to its reasonable satisfaction whether any claimed defect is covered by this Limited Warranty.

Certain items are excluded from Limited Warranty coverage by CURT, and this **Limited Warranty coverage does not apply to:**

- Wear and tear from normal use, including damage from road debris
- Improper product selection, application, installation or maintenance
- Modifications, including the attachment of other hardware or components
- Misuse, abuse, overloading, improper trailering or hauling, accident
- Corrosion or damage due to environmental conditions

REMEDIES UNDER THIS LIMITED WARRANTY

If a defect covered by this warranty occurs, CURT will repair or replace the Product, or refund the purchase price, in its sole discretion. This "repair, replacement or refund" remedy is the **sole and exclusive remedy** under this Limited Warranty. CURT has **no responsibility or liability for any incidental or consequential damages**, such as loss of use of vehicles or trailers, towing charges, storage charges, labor and service charges for removing or reinstalling products, loss of or damage to personal property, or interest or finance charges, all of which are specifically **excluded and disclaimed** from this Limited Warranty. For consumers in the U.S.: some states do not allow the exclusion or limitation of incidental or consequential damages, so the above limitation or exclusion may not apply to you.

RESPONSIBILITY OF PURCHASER

The Purchaser must have proof of purchase to obtain service under this Limited Warranty. Contact CURT for a Returned Goods Authorization (RGA) and return instructions; CURT will not accept Products unless an RGA has been issued. The Purchaser must deliver the Product to CURT or an authorized CURT dealer along with the RGA number and proof of purchase.

The CURT Limited Warranty policy in effect on the date you purchased your Product determines the applicable warranty coverage, and subsequent or prior CURT warranties are not applicable to your Product. The terms of this Limited Warranty cannot be changed or modified, except by a written agreement signed by an officer of CURT. CURT reserves the right to improve its products through changes in design or materials without being obligated to the owners of the Products of the same or similar models.

Contact information:
CURT Headquarters
6208 Industrial Drive
Eau Claire, WI 54701
877.287.8634



TRUST THE TOWING EXPERTS.™

CURT products are thoroughly tested and proven reliable so your customers have confidence for navigating the road ahead. That's why CURT continues to manufacture our custom-fit trailer hitches domestically in the USA and why we maintain dedicated testing and engineering teams for continuous improvement.

Our goal is to produce the widest variety of products that give your consumers the confidence to tow safely. At CURT, we value producing quality products that provide hardworking people the reliability they need when towing — from the contractor who tows daily to diehard sportsmen towing towards their next big adventure to ordinary families when venturing out on summer road trips.

CURT offers your customers the freedom to pursue their passion — whether they're towing a 30,000-pound trailer or packing up for a weekend getaway — and provides peace of mind for enjoying every single mile safely and securely.



**TO SEE OUR WARRANTY,
VISIT CURTMFG.COM**



CONNECT WITH US



PHONE
877.287.8634



WEB
CURTMFG.COM



SOCIAL MEDIA
@CURTMFG / #CURT

LOCATIONS

HEADQUARTERS

6208 INDUSTRIAL DRIVE
EAU CLAIRE, WI 54701

ATLANTA

110 NORTHPOINT PARKWAY
SUITE 200
ACWORTH, GA 30102

DALLAS

3535 N HOUSTON SCHOOL ROAD
SUITE 400
LANCASTER, TX 75134

EDMONTON

12642 184TH STREET NW
UNIT #2
EDMONTON, ALBERTA T5V 1T4

SEATTLE

6546 20TH STREET EAST
FIFE, WA 98424

SOUTH BEND

408 SOUTH BYRKIT AVENUE
MISHAWAKA, IN 46544

TORONTO

845 INTERMODAL DRIVE
UNIT #1
BRAMPTON, ON L6T 5W2