



2025 AFTERMARKET CATALOG





Lippert is a leading, global manufacturer and supplier of highly engineered products and customized solutions, dedicated to the promise that whenever, wherever, we make your experience better. We engineer, design and manufacture products in EMEA focusing on lightweight and space-saving product designs crucial for success in the European Caravan Market. With teams across the continent, we provide a complete line of high-quality products.

Whenever, wherever, we make your experience better.™

TABLE OF CONTENTS

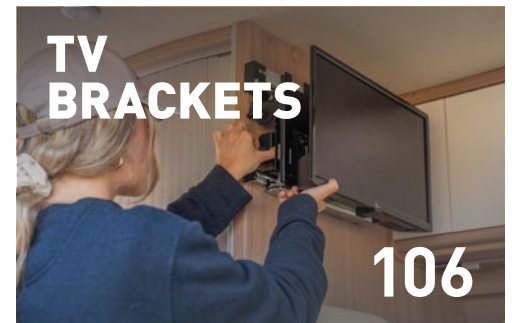
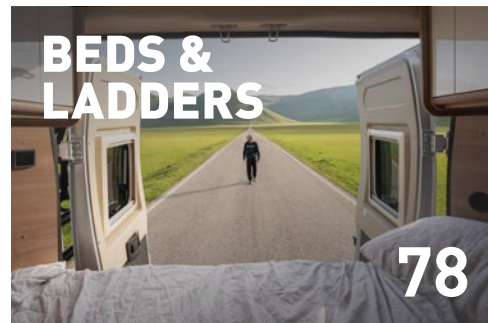

EXPLORE INSPIRE LIVE

At Lippert, our goal is to make products that help you discover the ultimate sense of freedom. With thousands of team members globally, innovation is at our core, and we will never wait to see what can be done better. Our products are inventive and inspired. We strive for the best Customer Service, period. Why? Because your adventure is on the line, and it's our job to make every future journey even better than those of the past.

Our purpose is clear: We are a Company where Everyone Matters. Every Customer. Every Team Member. We support the Communities we work in with over 100,000 hours of collective service every year. We make lives better.

**Whenever, wherever we
make your experience better.™**

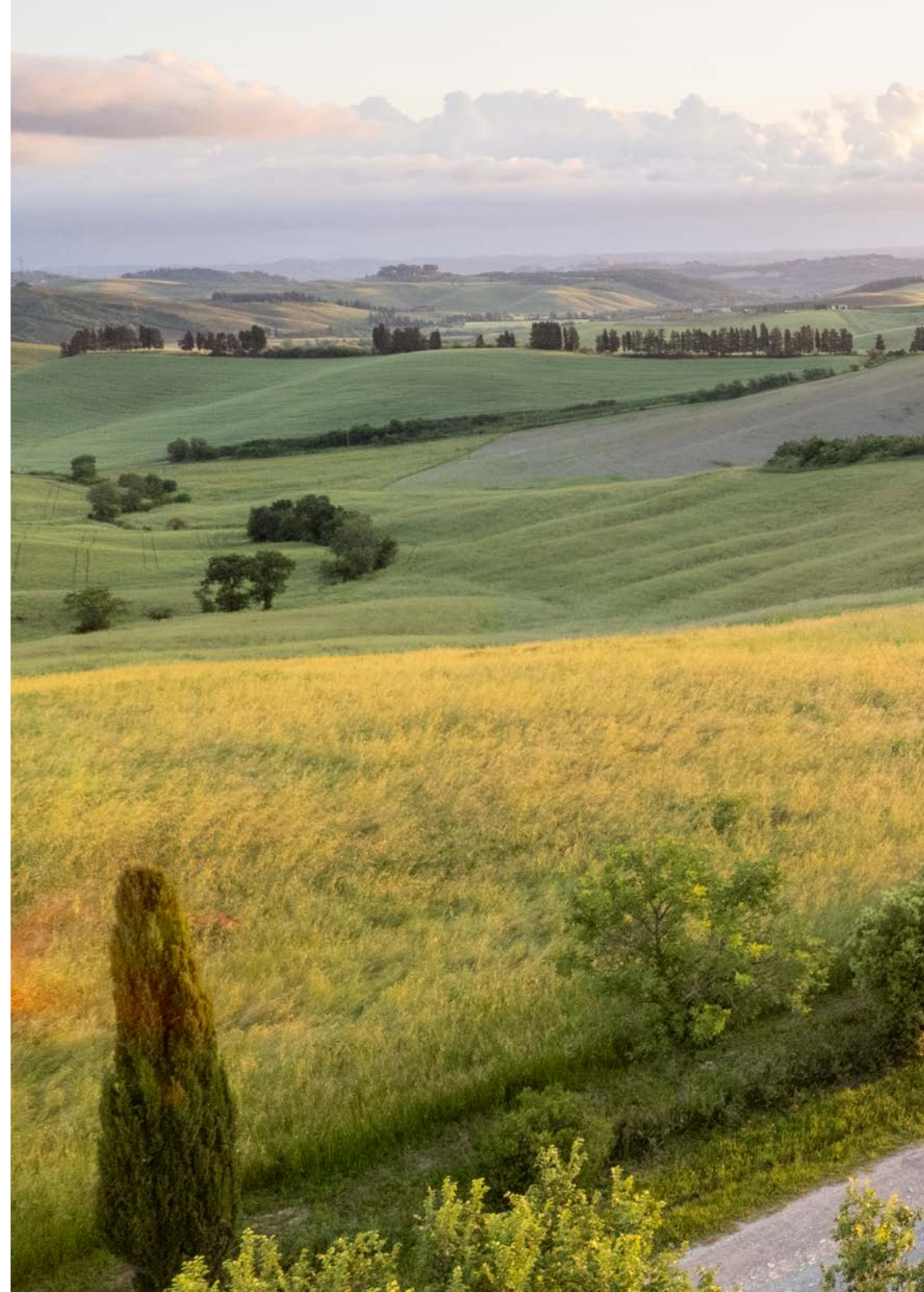





**SPACE ON
DEMAND**





Experience the freedom of the open road with our integrated Vela popup, perfect for creating more headroom in your camper van. For those moments when you need extra room, our Lippert slide-out provides space on demand, ensuring maximum comfort and convenience wherever your journey takes you.

VELA

Pop-up roof

- Designed for third generation Fiat Ducato H2
- Robust top and bottom panels are constructed with thermoformed technology using acrylonitrile butadiene styrene (ABS) and polymethyl methacrylate (PMMA) with closed-cell extruded polystyrene foam spacers
- Testing and quality protocols ensure performance, durability, and reliability
- Construction materials make this pop top lighter than standard rooftop units
- Canvas made from 100% double-coated polyester
- Two LED map lights illuminate the area around the bed for safety
- Pre-wired with electric cable to manage the roof light and solar panel (not included)
- Folding ladder available upon request
- Large aluminum bed frame with wooden slats provides ample sleeping space (mattress not included)
- Available only with blind spoiler



Provides an extra sleeping area with access through the roof of the unit



Integrated USB ports conveniently charge phones, tablets and more



Two rooftop LED light strips provide overhead lighting

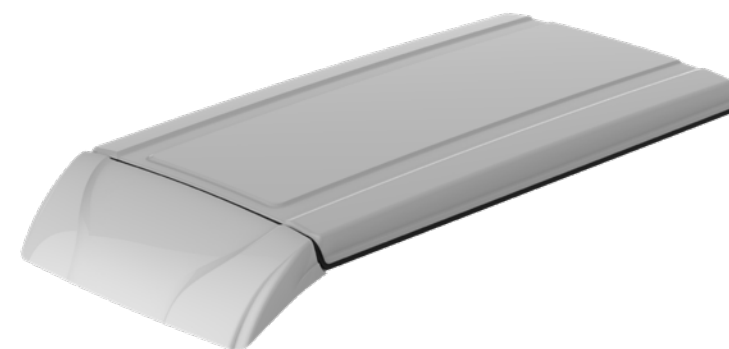

Part #	Space	↕ Length	↕ Width	↕ Height	📦	Solar Panel Allowance
2022015540	Closed	3.000 mm	1.620 mm	260 mm	150 kg	220 watts
	Opened	3.000 mm	1.620 mm	1.080 mm		
	Entrance	1.000 or 1.100 mm	600 mm	--		
	Bed base	1.950 mm	1.250 mm	35 mm		
	Accepts mattress size	1.950 mm	1.250 mm	50 mm		

Color options*



White



Window grey

* Color swatches are representative only. Please call for exact color specifications.

BELVEDERE

Pop-up roof

- Designed for fourth generation Ford Transit
- Provides an extra sleeping area with primary access through the roof of the unit
- Top is constructed out of fiberglass-laminated external sheets with closed-cell extruded polystyrene foam panels and a PVC frame for increased resistance to wear and tear
- Robust bottom panel is constructed with thermoformed technology using acrylonitrile butadiene styrene (ABS) and polymethyl methacrylate (PMMA) with closed-cell extruded polystyrene foam spacers
- Testing and quality protocols ensure performance, durability, and reliability
- Construction materials make this pop top lighter than standard rooftop units
- Thermo-insulated panels keep campers warm
- Canvas made from 100% double-coated polyester
- Two LED map lights illuminate the area around the bed for safety
- Integrated USB ports conveniently charge phones, tablets, and more
- Folding ladder available upon request
- Large aluminum bed frame with wooden slats provides ample sleeping space (mattress not included)
- Available with or without blind spoiler (ask about VISTA window system)

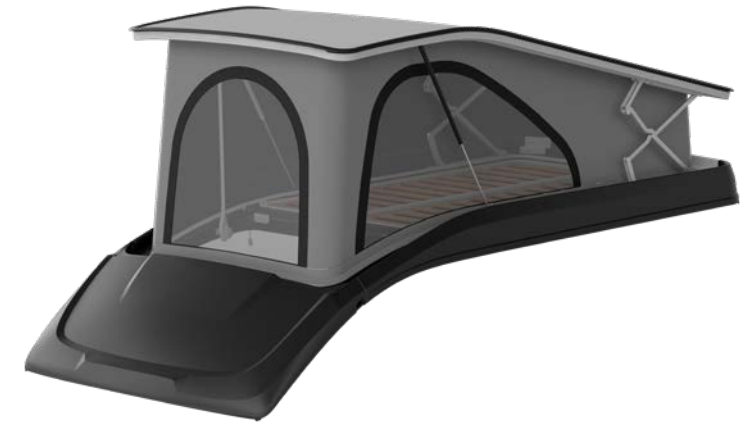

Part #	Space	↕ Length	↔ Width	↕ Height	📦	Solar Panel Allowance
2022110788	Closed	2.910 mm	1.625 mm	170 mm	117 kg	220 watts
	Opened	2.910 mm	1.625 mm	1.050 mm		
	Entrance	600 mm	1.000 mm	--		
	Bed base	1.950 mm	1.180 mm	35 mm		
	Accepts mattress size	1.950 mm	1.180 mm	50 mm		

Color options*



White



Window grey

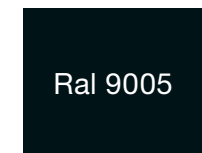

Jet black

* Color swatches are representative only. Please call for exact color specifications.



BIKE CARRIERS





Lippert bike carriers are designed to take your bikes on any adventure. We offer a variety of styles to seamlessly integrate with your van or campervan layout. Our versatile designs provide a reliable solution for confidently transporting all types of recreational equipment.



R-BIKE VAN

Bike carrier | Van

- Designed for conversion vans
- Accepts two e-bikes or standard bikes
- Extends to fit three standard bikes with R-Bike 3Rail accessory (sold separately)
- Designed for easy installation and mounting
- Designed for serviceability and compatible with multiple accessories
- Comes standard in anodized aluminum or upgrade to corrosion-resistant automotive finish
- Meets ECE R26 vehicle safety mounting regulations



Built-in anti-vibration device deters unwanted noise when traveling on rough terrain



Accepts two e-bikes or standard bikes (up to three standard bikes with 3Rail accessory)



Robust and secure construction protects valuable bikes



Tray-style rail folds up when not in use for compact storage



2021104471
(R-Bike Ducato - Alu)



2023022085
(R-Bike Ducato - Total black)



2022013188
(R-Bike Ducato - Grey)

Color options*

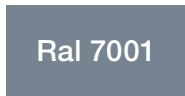

Alu
(anodized aluminum)

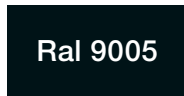

Total black
(automotive finish)



Black / Orange
(automotive finish)

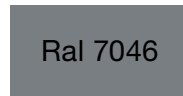

Grey
(automotive finish)

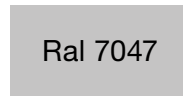

White
(automotive finish)

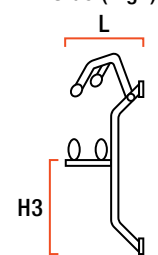
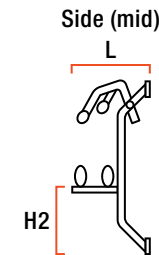
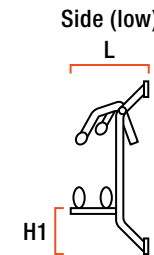
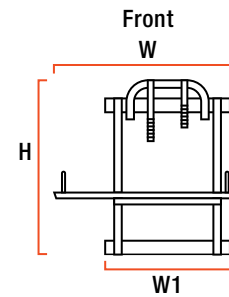

In the low and middle positions, it is mandatory to use the license plate bar with light unit

Make	Model	Roof	Years	Alu #	Total Black #	Black #	Grey #	White #	# of Bikes	↕ W*	↕ W1*	↕ H*	↕ H1*	↕ H2*	↕ H3*	↕ L*	📦*	📦*
Citroën	Jumper	H2 / H3	2007+	2021104471	2023022085	2021104457	2022013188	2022013187	2	1.328	825	1.259	284	484	684	564	10	50
Fiat	Ducato	H2 / H3	2007+	2021104471	2023022085	2021104457	2022013188	2022013187	2	1.328	825	1.259	284	484	684	564	10	50
Ford	Transit	H3	2014+	2021104454	2023015966	2021104468	2022110789	2022110790	2	1.328	847	1.509	191	391	591	610	10,5	50
Mercedes-Benz	Sprinter	H2	2020+	2021104423	2023055898	2021104493	2022110791	2022110792	2	1.328	831	1.412	191	391	591	610	10,5	50
Nissan	Interstar	H2	2014+	2022110795	2023022086	2022013189	2022110796	2022110797	2	1.328	847	1.509	191	391	591	610	10,5	50
Opel	Movano	H2	2014+	2022110795	2023022086	2022013189	2022110796	2022110797	2	1.328	847	1.509	191	391	591	610	10,5	50
Peugeot	Boxer	H2 / H3	2007+	2021104471	2023022085	2021104457	2022013188	2022013187	2	1.328	825	1.259	284	484	684	564	10	50
Renault	Master	H2	2014+	2022110795	2023022086	2022013189	2022110796	2022110797	2	1.328	847	1.509	191	391	591	610	10,5	50
Volkswagen	Crafter	H3	2017+	2021104443	2023022084	2021104435	2022110793	2022110794	2	1.328	821	1.353	191	391	591	610	10,5	50

* Measurements are shown in mm / weights shown in kg

* Color swatches are representative only. Please call for exact color specifications.



R-BAR

Accessory | R-Bike

- Converts R-Bike Van into a multi-use carrier for transporting various recreational equipment
- Designed for use with R-Skirun and R-Wave accessories
- Easy bolt-on installation
- Includes two bars and mounting hardware
- Available in four color options



2021104447 (Alu)



2021104487 (Black)



2022110798 (Grey)



2022110799 (White)

Alu #	Black #	Grey #	White #
2021104447	2021104487	2022110798	2022110799

All pictures shown are for illustration purpose only. Actual product may vary due to product enhancement.

R-SKIRUN

Accessory | R-Bike

- Contains skis and snowboards for safe, stress-free transportation
- Innovative design allows for the door to be opened while skis are loaded
- Equipped with robust locking system and double-key padlock for cargo security
- Ergonomic release button for comfortable unloading
- Made from anodized aluminum and injection molded plastic to withstand the wear and tear of travel
- Holds up to four pairs of coupled skis or two pairs of skis with two snowboards



2022110802



Contains skis and snowboards for safe, stress-free transportation



Equipped with robust locking system and double-key padlock for cargo security

Part #	↕ W	↕ H	↕ L	🛒	🛒
2022110802	620 mm	130 mm	60 mm	3,2 kg	28 kg

MAX LOAD 🛒

PRODUCT WEIGHT 🛒

DIMENSION ↕

R-WAVE

Accessory | R-Bike

- Modular racking system for transporting water equipment like surfboards and canoes
- Innovative design allows for the door to be opened while surfboards and canoes are loaded
- Versatile design allows for use with different sized surfboards (up to 250 cm) and canoes of comparable size
- Made from aluminum tubular pillars and a soft foam rubber for damage-free, heavy-duty use
- Racking system includes three pillars, two fabric bags, two upper straps, and four front straps for optimal restraint against shifting
- Straps are easy to adjust for convenience and flexibility



Straps are easy to adjust for convenience and flexibility



Easily and securely installs with the provided hardware and hand clamps

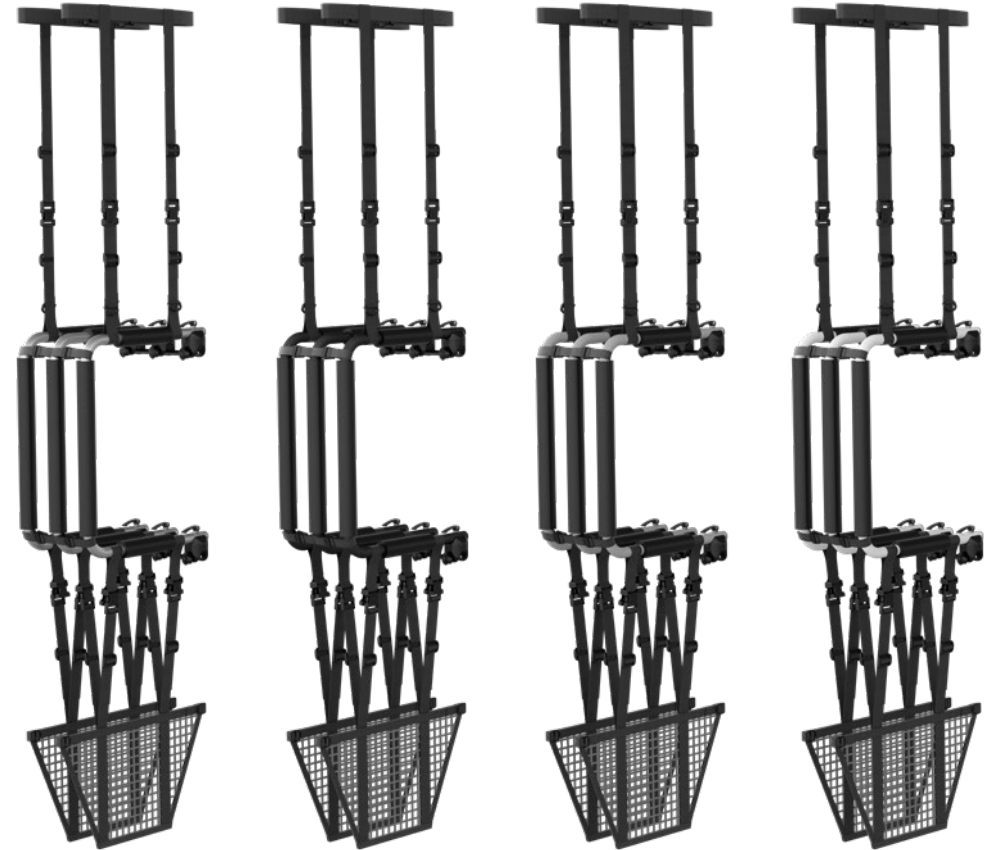

2023021880 (Alu)

2023021881 (Total black)

2023021882 (Grey)

2023021883 (White)

Alu #	Total Black #	Grey #	White #	↕ W	↕ H	↕ D	🛒	🛒	Holds
2023021880	2023021881	2023021882	2023021883	512 mm	713 mm	310 mm	7 kg	50 kg	Up to five surfboards, three surfboards and one canoe or one surfboard and two canoes



**POP UP
YOUR VAN**

LIPPERT

BIKE CARRIERS

R-BIKE 3RAIL

Accessory | R-Bike

- Allows R-Bike Van to transport three standard bikes



2021104446 (Alu)



2023018452 (Total black)



2021104439 (Black)



2022110800 (Grey)



2022110801 (White)

Alu #	Total Black #	Black #	Grey #	White #
2021104446	2023018452	2021104439	2022110800	2022110801

R-BRAKO PLIE

Accessory | R-Bike

- Locking arm provides enhanced security for bikes
- Pivoting center hinge allows for versatile fit
- Available in five color options



2021104458 (Alu)

2023019751 (Total black)

2021104440 (Black)



2022110803 (Grey)

2022110804 (White)

Alu #	Total Black #	Black #	Grey #	White #
2021104458	2023019751	2021104440	2022110803	2022110804

REPLACEMENT PARTS

R-Bike



Name	Description	Alu #	Total Black #	Black #	Grey #	White #
R-Brako 1	Locking bike arm, short	2021104490	2023022088	2021104472	2022110805	2022110806
R-Brako 2	Locking bike arm, long	2021104486	2023022089	2021104497	2022110807	2022110808
R-Rail	Tray-style rail	2022110811	2023022090	2021104492	2022110809	2022110810
R-Wire	Cinching strap for bike R-Rail	--	2023022091	--	--	--
R-Cap	Rail end caps	--	2023022093	2021104467	--	--
R-Knob	Tightening knob	--	2023022092	2021104491	--	--
R-Yolda Wire	Anti-slip spacer for R-Wire	--	2021104459	--	--	--
R-Yolda Brako	Arm brackets for all R-Brako	--	2021104441	--	--	--



HOLDY

Bike tie-down system

- Allows bikes and motorbikes to be secured in the motorcaravan's garage
- Lightweight aluminum construction provides superior corrosion resistance
- Includes two rails and five tie-down loops on each rail
- Easily installs with provided hardware (glue optional)

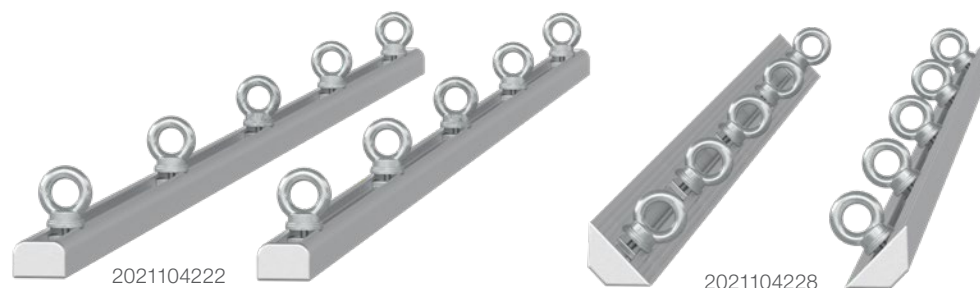

Allows bikes and motorbikes to be secured in the motorcaravan's garage



2021104225

Part #	Name	Description	↕ L	↕ W	↕ H
2021104222	Holdy Flat	Garage bike anchoring system, flat	2.000 mm	25 mm	35 mm
2021104228	Holdy Corner	Garage bike anchoring system, corner	2.000 mm	21 mm	56 mm
2021104225	Holdy Hang	Replacement hooks	--	--	--



LIPPERT

LIPPERT

CARAVANNING SOLUTIONS
FOR YOUR ADVENTURES

LIPPERT

lippertcomponents.eu



WINDOWS & ROOF VENTS





Polyplastic caravan, camper, and van window systems provide a clear view of the adventure, featuring quality construction and intuitive functionality coupled with seamless integrated designs. We offer standard window systems and custom solutions to provide countless options in varying configurations and sizes.



POLYPLASTIC

BY  LIPPERT

Polyplastic, a Lippert brand, offers a unique combination of state-of-the-art manufacturing and contactless thermoforming technology. We produce superb, transparent, lightweight cast acrylic-based solutions across a variety of industries. For more than 70 years, our customers have enjoyed the benefits of our passion for design, customized focus and rich industry experience, coupled with highly-engineered machinery, short lead times, and exceptional optical and thermal performance.

General Polyplastic by Lippert window system features

- In-house produced cast acrylic PMMA (Roxite® Premium)
- Stronger on impact compared to glass (approx. 11x)
- Made from shatterproof, high-transparent material
- Exceptional optical and thermal performance
- Higher light transmission versus other solutions
- 10-year UV protection against fade and discoloration
- Easy-to-clean and no maintenance required
- Specially designed accessories
- Decorative screen print options available
- Standard two-year warranty
- Homologated according to UN/ECE R43 and FMVSS 205 approved

Purchasing a Polyplastic window system requires a sequence of steps. Please reach out to our sales department for assistance with determining the best systems, accessories, sizing, and customization options for your unique setup. For questions or additional information, please visit lippertcomponents.eu. We are also available by phone or email at +31(0)104461100 / info@polyplastic.nl.

WINDOW SYSTEMS

Application and installation

See the options for vehicle application and installation of our standard window systems in the overview below.



Polyvision Aero



Polyvision Slide



Polyvision Curved



Polylux



Piuma

Market	Category	Window Name	Pane	Vehicle Application			Vehicle Installation Location				
				Camper	Caravan	Van	Front	Side	Rear	Roof	Panorama
Semi-integrated	Aluminum frame window systems	Polyvision Aero	Double	✓	✓	--	--	✓	✓	--	--
		Polyvision Slide	Double	✓	✓	--	--	✓	✓	--	--
		Polyvision Curved	Double	--	--	✓	--	✓	✓	--	--
Fully-integrated	Aluminum frame window system	Polylux	Double	✓	✓	✓*	--	--	--	✓	--
	Polymer frame window system	Piuma	Double	✓	✓	--	--	✓	✓	--	--

* Only when using customer adapter

POLYVISION AERO

Semi-integrated | Aluminum frame

- Manually operated tilt window
- Aerodynamic, flush design
- For installation in straight walls
- Lightweight powder-coated aluminum frame
- Unique integrated thermal bridge inside window frame to reduce condensation
- Customize by making choices for standard parts and system options
- Pre-assembled for quick and easy installation

Accessory options

- Interior blind and flyscreen
- Cover profile

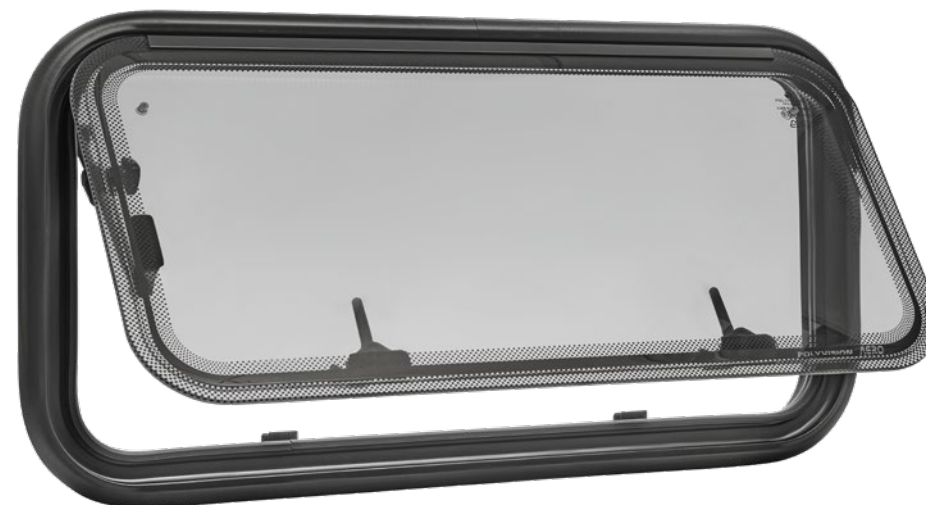

Flush design, suitable for straight walls



Strong and lightweight powder-coated aluminum frame



Includes integrated screwed catches



Tubular or automatic stays allow for opening in every position

Part #	Wall Aperture			Radius	Build-up Height from Wall	Wall Thickness
	H	W	Radius			
2021104657	520 mm	700 mm				
2021104661	520 mm	900 mm				
2021104621	400 mm	700 mm	75 mm	7 mm to 17 mm	24 mm to 44 mm	
2021104710	560 mm	600 mm				
2021104644	450 mm	600 mm				

Part #	Wall Aperture			Radius	Build-up Height from Wall	Wall Thickness
	H	W	Radius			
2021104693	550 mm	600 mm				
2021104636	400 mm	500 mm				
2021104654	520 mm	500 mm	75 mm	23 mm to 33 mm	24 mm to 44 mm	
2021104694	500 mm	900 mm				
2021104622	450 mm	800 mm				

POLYVISION SLIDE

Semi-integrated | Aluminum frame

- Manually operated sliding window
- Unique sleek design
- For installation in straight walls
- Lightweight powder-coated aluminum frame
- Sliding rails for easy open / close operation
- Customize by making choices for standard parts and system options
- Pre-assembled for quick and easy installation
- Compatible with other Polyvision window systems

Accessory options

- Interior blind and flyscreen
- Cover profile



Specially designed, integrated catch for easy operation

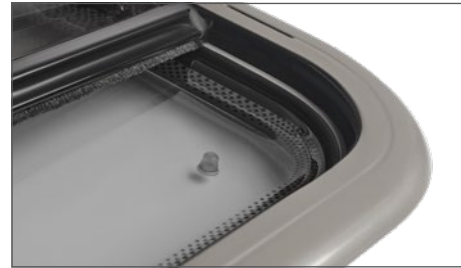

Strong and lightweight powder-coated aluminum frame



Sleek design, suitable for straight walls



Window comes standard with decorative screen print

Part #	Wall Aperture			Hand icon	Wall Thickness
	H	W	Radius		
2022005612	550	500			
2022005613	400	500	75 mm	7 mm to 33 mm	24 mm to 38 mm
2022005614	400	700			

Part #	Wall Aperture			Hand icon	Wall Thickness
	H	W	Radius		
2022005615	450	900	75 mm	7 mm to 33 mm	24 mm to 38 mm
2022005616	450	960			

POLYVISION CURVED

Semi-integrated | Aluminum frame

- Manually operated tilt window
- Curved, aerodynamic, flush design
- Designed for curved walls with radius 4991 mm
- Lightweight powder-coated aluminum frame
- Unique integrated thermal bridge inside window frame to reduce condensation
- Customize by making choices for standard parts and system options
- Pre-assembled for quick and easy installation

Accessory options

- Interior blind and flyscreen
- Cover profile

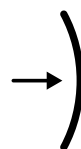

Profile curve radius



Flush design, suitable for curved walls



Strong and lightweight powder-coated aluminum frame



Includes integrated screwed catches



Tubular or automatic stays allow for opening in every position

Part #	Wall Aperture			Profile Curve Radius	Wall Thickness
	H	W	Radius		
2021104697	550 mm	900 mm	75 mm	4.991 mm	24 mm to 44 mm
2021104641	520 mm	315 mm			
2021104660	750 mm	465 mm			
2021104716	490 mm	500 mm			
2021104643	258 mm	396 mm			

Part #	Wall Aperture			Profile Curve Radius	Wall Thickness
	H	W	Radius		
2021104669	686 mm	298 mm	75 mm	4.991 mm	24 mm to 44 mm
2021104620	280 mm	380 mm			
2021104692	220 mm	680 mm			
2021104635	818 mm	315 mm			

POLYLUX

Fully-integrated | Aluminum frame

- Electrically-operated, sliding roof window (12V, 20 A, 240W)
- Low, aerodynamic window system for flat surfaces
- Lightweight powder-coated aluminum frame
- Low noise level while driving
- Driving when open permitted
- Operation temperature from -20°C to +50°C
- Released for use up to 160 km/h
- Customize by making choices for system options

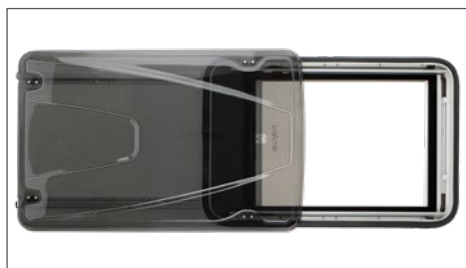
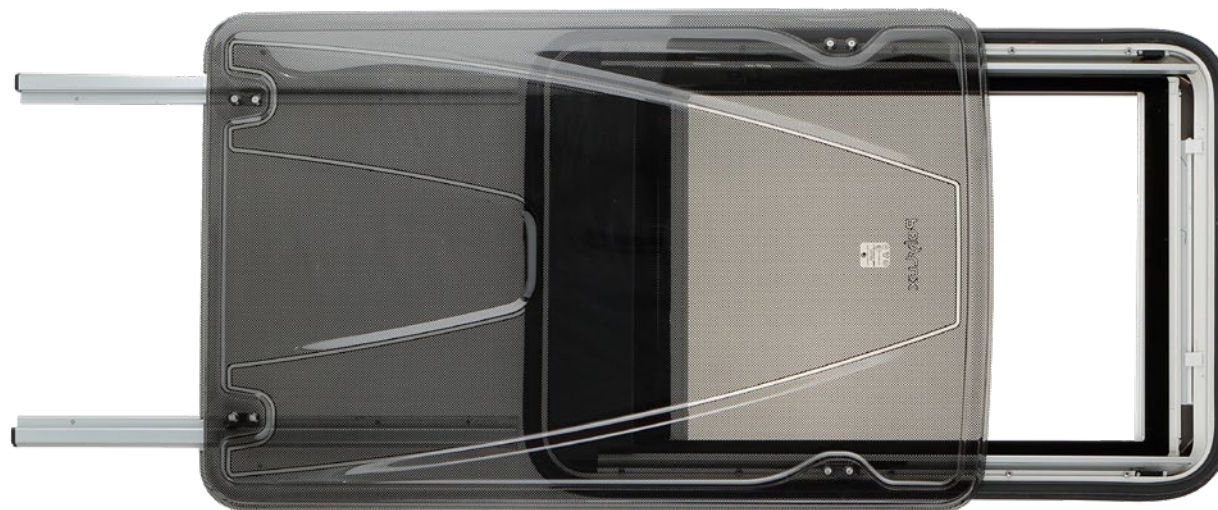

Low noise level while driving



Integrated blind and flyscreen



Electrically-operated, sliding roof window



Easy operation with the touch of a button

Part #	↕ Wall Aperture Height	↔ Wall Aperture Width	Roof Aperture Radius	↕	Roof Thickness	🛒
2021104662	655 mm	960 mm	65 mm	69 mm to 79 mm	24 mm to 45 mm	19,5 kg

PIUMA

Fully-integrated | Polymer frame

- Lightweight manually-operated tilt window
- Extremely flush and minimalistic design
- Complete, super-thin window system, including frame, integrated rolo blind system, and click-on interior finish
- For installation in straight walls
- Injection molded polymer frame
- Two-part assembly with integrated mounting clamps allows for easy installation in minutes
- Custom screen print design possible



Integrated mounting clamps for easy installation



Flush, minimalistic interior finish



Easy assembly due to two-piece setup



Unique catch design with integrated lock buttons

Yellow Clamp #	Green Clamp #	Blue Clamp #	Wall Aperture			Hand Icon	Wall Thickness
			H	W	Radius		
2023039863	2023039864	2023039865	400 mm	500 mm	12 mm	5 to 15 mm	Yellow Clamps for 24 mm - 30 mm
2023039866*	2023039867*	2023039868*	400 mm	500 mm			
2023039869	2023039870	2023039871	400 mm	700 mm			
2023039872	2023039873	2023039874*	580 mm	350 mm			Green Clamps for 31 mm - 35 mm
2023039860	2023039861	2023039862	580 mm	700 mm			
2023039854	2023039855	2023039856	580 mm	900 mm			
2023039857	2023039858	2023039859	580 mm	1.300 mm			

* Opal white inner acrylic sheet provides privacy

REPLACEMENT PARTS & ACCESSORIES

Blocks, hooks and clamps

End caps

- Used as an endcap for the side of a cut hinge bar
- Multiple configurations available, see table below

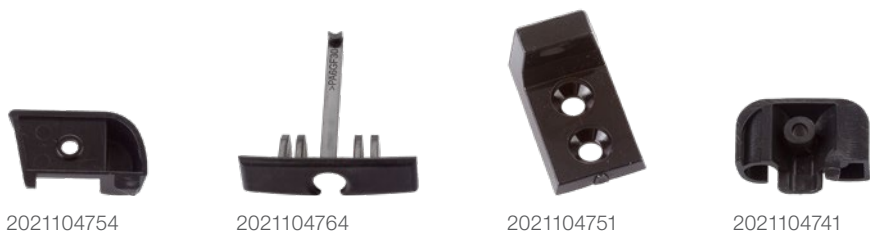

2021104754

2021104764

2021104751

2021104741

Polyfix adapter

- Fits onto a window system as a lock for Polyfix catches and stays
- Catches and stays can slide across the adapter into a locked position
- Easy to remove with the dismantling tool



2021104767

Part #	Description	Fits	Quantity
2021104754	Endcap hook in 1	Hinged window systems	1.000 pieces
2021104764	Endcap hook in 1 T maxirail	Hinged window systems	2.000 pieces
2021104751	Endcap hook in 2	Hinged window systems	1.200 pieces
2021104741	Endcap T	Hinged window systems	2.500 pieces
2021104767	Polyfix adapter	All window systems	6.000 pieces

Corner blocks

- Corner block to make a 75 mm radius curve when the wall aperture is straight



2021104726

2021104742

Mounting clamps

- Used to attach Polyvision frames to the wall
- For correcting and leveling the frame
- Screws required for installation



Part #	Description	Fits	Quantity	Wall Thickness
2021104726	Corner block, 20 mm thick	All window systems	1.000 pieces	--
2021104742	Corner block, 25 mm thick	All window systems	1.000 pieces	--
2021104730	Mounting clamp S	Alum. framed window sys	1.000 pieces	24 - 33 mm
2021104772	Mounting clamp M	Alum. framed window sys	1.500 pieces	33 - 36 mm
2021104745	Mounting clamp XXL	Alum. framed window sys	1.000 pieces	38 - 45 mm



REPLACEMENT PARTS & ACCESSORIES

Bands and seals

Cover bands

- Used as interior finish to cover gaps and hide the misalignment of the window inside of the RV or caravan
- Available in black or white



2021104766

Insert bands

- Used as a decorative cover in a rubber profile
- Offers a clean and tight finish
- Available in white or graphite



2021104763



2021104769

Part #	Description	Fits	Color	Length	Wall Thickness
2021104766	Cover band, sm	Alum. framed window systems	White	100 m	24 - 37 mm
2021104752	Cover band, lrg	Alum. framed window systems	Black	100 m	38 - 44 mm
2021104763	Insert band	Hinged window systems	White	500 m	--
2021104769	Insert band	Hinged window systems	Graphite	500 m	--

Locking and fill plates

Locking plates

- Used as a lock for catches and stays
- Includes a special night position for extra ventilation
- Contact sales for application



2021104749



2021104757

Fill plate

- Used to add height to a locking plate
- Contact sales for application



2021104734

Fix plate

- Used to attach a window system to the wall
- Contact sales for application



2021104758

Part #	Description	Height	H-W-S (mm)	Fits	Quantity
2021104749	Locking plate	17,5 mm	17,5 - 50 - 37,5	Non-integrated window sys.	1.200 pcs
2021104757	Locking plate	13 mm	13 - 50 - 37,5	Non-integrated window sys.	1.500 pcs
2021104734	Fill plate	4,5 mm	4,5 - 50 - 37,5	Non-integrated window sys.	1.500 pcs
2021104758	Fixing plate	--	--	Non-integrated window sys.	1.000 pcs

Tools

Scissor

- Used for cutting the wall aperture rubber into the right length



2021104724

Dismounting tool

- Used to dismount Polyfix catches and stays



2022110939

Insert band fitting tool

- Used to put the insert band into the rubber



2021104765

Rubber plast key fitting tool

- Used for fitting the rubber plast



2021104736

Part #	Description	Fits	Quantity
2021104724	Scissor for wall aperture rubber	Non-integrated window systems	1
2022110939	Dismounting tool	Non-integrated window systems	1
2021104765	Insert band fitting tool	Non-integrated window systems	1
2021104736	Rubber plast key fitting tool	Fixed window systems	1

REPLACEMENT PARTS & ACCESSORIES

Catches

Screwed

- Universal screwed catches are used to open, close, and lock the windows
- Due to the locking plates, the catches have a special night position for extra ventilation; this cannot be seen standing at the outer side of the window
- Available with or without a lock button
- All catches come in black



2021104665



2021104737

Polyfix

- Polyfix is a patented, quick fit system that offers time savings when fitting accessories to the window
- The complete Polyfix system consists of catches, adapters, locking plates, and fill plates
- Easily slides across a Polyfix adapter into a locking position
- Saves time compared to a screwed version
- Most Polyfix adapters are already placed on the window in the factory



2022110940



2021104760



Part #	Description	Fits	Quantity
2022110940	(A) Catch Polyfix without lock button, right	Polyfix windows	700 pieces
2021104760	(B) Catch Polyfix with lock button, right	Polyfix windows	600 pieces
2021104665	(C) Catch screwed without lock button, right	Polyfix windows	700 pieces
2021104737	(D) Catch screwed with lock button, right	Polyfix windows	600 pieces
2022110941	Catch pads	All catches	75.000 pieces

Market	Non-Integrated				Semi-Integrated	Fully Integrated		Special
Window Category	Fixed window systems		Hinged window systems		Aluminum framed window systems	Aluminum framed window systems	Polymer framed window systems	Special window systems or exclusive customer series
Window Type	Single	Double	Single	Double	Double	Double	Double	Single or Double
Catch	--	--	--	A,B	A,B (Eco) C,D (Aero, Curved)	--	D (Vista)	A,B or none (if fixed)

REPLACEMENT PARTS & ACCESSORIES

Stays

Automatic

- Easy-to-use aluminum automatic stays to open / close the window in steps
- Aluminum sliding movement inside with built-in locking positions
- Can be fixed in multiple positions due to the steps
- Available in screwed or Polyfix configurations
- Available with or without catch and in left or right-hand configurations



Tubular

- Easy-to-use aluminum tubular stays to open / close the window
- Aluminum sliding movement inside
- Can be fixed in any position by rotating the thumb clamp
- Available in screwed or Polyfix configurations
- Available with or without catch and in left or right-hand configurations



Part #	Description	Configuration	With Catch	Length	Quantity
2022110955	Automatic screwed	Left-hand	Yes	230 mm	15 boxes / 100 pcs
2022110956	Automatic screwed	Right-hand	Yes	230 mm	15 boxes / 100 pcs
2022110957	Automatic screwed	Left-hand	Yes	277 mm	15 boxes / 100 pcs
2022110958	Automatic screwed	Right-hand	Yes	277 mm	15 boxes / 100 pcs
2022110959	Automatic Polyfix	Left-hand	Yes	209 mm	1 box / 100 pieces
2022110960	Automatic Polyfix	Right-hand	Yes	209 mm	1 box / 100 pieces
2022110961	Automatic Polyfix	Left-hand	Yes	230 mm	30 boxes / 100 pcs
2022110962	Automatic Polyfix	Right-hand	Yes	230 mm	45 boxes / 100 pcs
2022110963	Automatic Polyfix	Left-hand	Yes	277 mm	1 box / 100 pieces
2022110964	Automatic Polyfix	Right-hand	Yes	277 mm	1 box / 100 pieces
2022110965	Automatic Polyfix	Left-hand (front 70)	Yes	265 mm	1 box / 100 pieces
2022110966	Automatic Polyfix	Right-hand (front 70)	Yes	265 mm	1 box / 100 pieces
2022110967	Automatic Polyfix	Left-hand	No	209 mm	1 box / 100 pieces
2022110968	Automatic Polyfix	Right-hand	No	209 mm	1 box / 100 pieces
2022110969	Automatic Polyfix	Right-hand	No	230 mm	1 box / 100 pieces

Part #	Description	Configuration	With Catch	Length	Quantity
2022110942	Tubular screwed	Left-hand	Yes	295 - 466 mm	1 box / 100 pieces
2022110943	Tubular screwed	Right-hand	Yes	295 - 466 mm	1 box / 100 pieces
2022110944	Tubular Polyfix	With child protection	--	--	1 box / 100 pieces
2022110945	Tubular Polyfix	Left-hand	Yes	136 - 206 mm	1 box / 100 pieces
2022110946	Tubular Polyfix	Right-hand	Yes	136 - 206 mm	1 box / 100 pieces
2022110947	Tubular Polyfix	Left-hand	Yes	295 - 466 mm	1 box / 100 pieces
2022110948	Tubular Polyfix	Right-hand	Yes	295 - 466 mm	1 box / 100 pieces
2022110949	Tubular Polyfix	Left-hand	Yes	277 - 466 mm	1 box / 100 pieces
2022110950	Tubular Polyfix	Right-hand	Yes	277 - 466 mm	1 box / 100 pieces
2022110951	Tubular Polyfix	Left-hand	Yes	230 - 393 mm	1 box / 100 pieces
2022110952	Tubular Polyfix	Right-hand	Yes	230 - 393 mm	1 box / 100 pieces
2022110953	Tubular Polyfix	Left-hand	No	230 - 370 mm	1 box / 100 pieces
2022110954	Tubular Polyfix	Right-hand	No	230 - 370 mm	1 box / 100 pieces

REPLACEMENT PARTS & ACCESSORIES

Rubber profiles

Standard

- Standard rubber profile to provide an optimum, watertight seal between the wall and window system
- The rubber profile is mounted on the inside of the wall aperture
- The rubber profile has a special designed soft bulb made of sponge rubber
- Special butyl adhesive layer inside the rubber profile ensures a perfect seal
- A decorative insert band complements the rubber profile
- Available in black



Fixed system

- Rubber profile for fixed window systems, to provide an optimum, watertight seal between the wall and window system
- The rubber profile is mounted on the inside of the wall aperture
- Rubber profile must be combined with key profile to lock the window in place
- Special butyl adhesive layer inside the rubber profile ensures a perfect seal
- Available in black



Key profile

- Used to lock the window in place

Part #	Description	Fits	Color	Length	Wall Thickness
2021104637	Standard profile	Non-integrated window systems	Black	480 m	20 - 24 mm
2021104617	Standard profile	Non-integrated window systems	Black	480 m	22 - 26 mm
2021104659	Standard profile	Non-integrated window systems	Black	480 m	24 - 28 mm
2021104663	Standard profile	Non-integrated window systems	Black	480 m	26 - 30 mm
2021104655	Standard profile	Non-integrated window systems	Black	480 m	28 - 32 mm
2021104712	Standard profile	Non-integrated window systems	Black	480 m	30 - 34 mm
2021104666	Standard profile	Non-integrated window systems	Black	480 m	32 - 36 mm
2021104656	Standard profile	Non-integrated window systems	Black	480 m	36 - 40 mm
2021104762	Standard profile, separate bead	Non-integrated window systems	Black	480 m	28 - 32 mm

Part #	Description	Fits	Color	Length	Wall Thickness
2021104618	Fixed profile	Non-integrated window systems	Black	480 m	22.5 - 25 mm
2021104664	Fixed profile	Non-integrated window systems	Black	100 m	23.5 - 26 mm
2021104755	Key profile	Non-integrated window systems	Black	--	--

HOSEW & HOSEW-BAR

Roof vents

- Multi-position opening allows custom control of airflow
- Integrated, easy-to-use handles
- White Ral 9010 structure with smoked methacrylate cover
- Available with or without aluminum bars
- Manufactured by Lippert for trailers only



2021104668 - inside

2021104668 - outside

Part #	Style	Color / Description	↕ Wall Aperture Width	↕ Wall Aperture Height
2022074985	HOSEW-BAR	Smoked methacrylate with white aluminum bars	550 mm	350 mm
2022013510	HOSEW	Smoked methacrylate without bars	550 mm	350 mm
2022008241	--	Frame only (ABS plastic)	550 mm	350 mm
2022111925	--	Smoked methacrylate with white aluminum bars and frame	550 mm	350 mm



DOORS & SERVICE DOORS

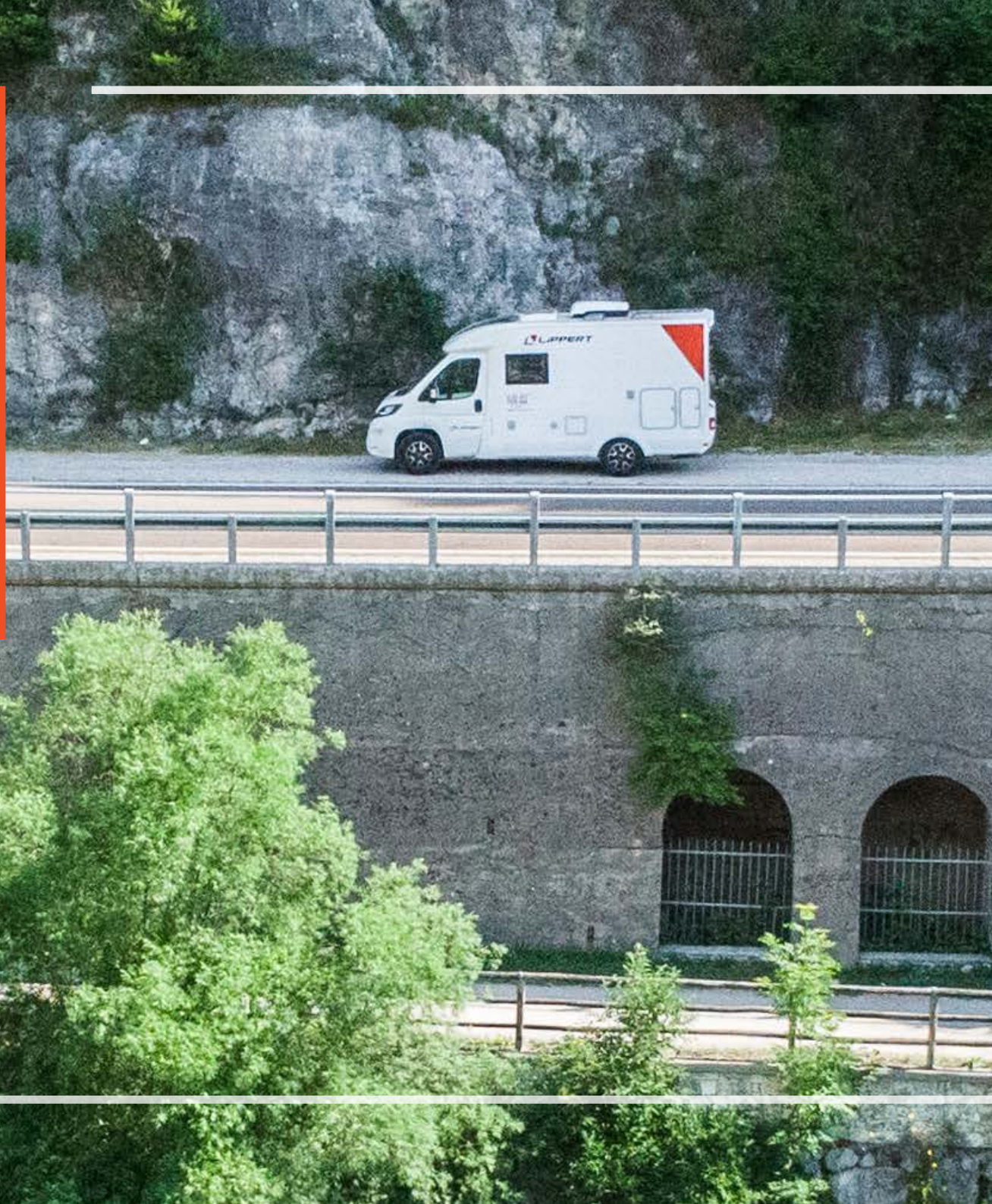

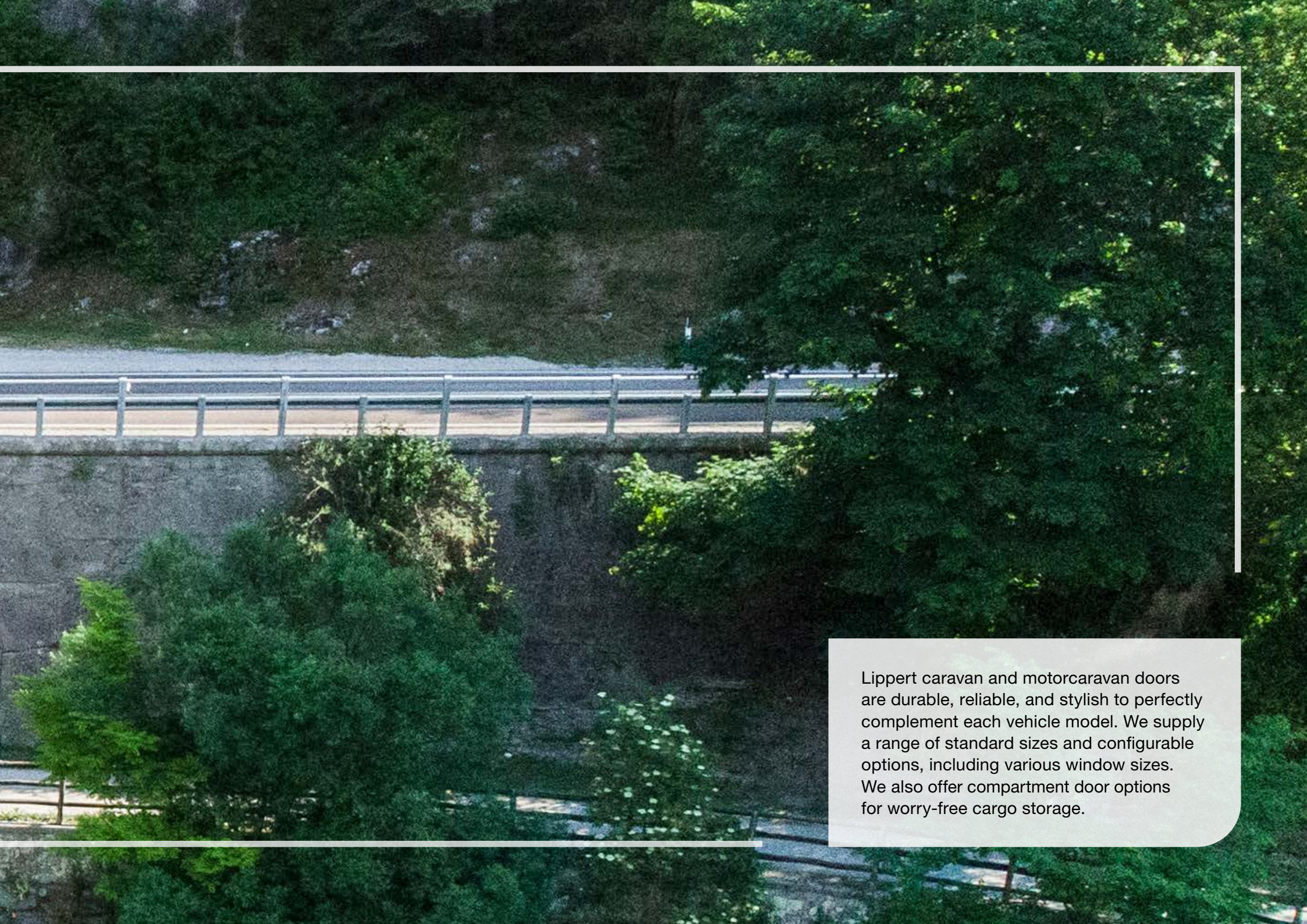

Lippert caravan and motorcaravan doors are durable, reliable, and stylish to perfectly complement each vehicle model. We supply a range of standard sizes and configurable options, including various window sizes. We also offer compartment door options for worry-free cargo storage.

CLASSY

Entry door | One-point lock

- One-point locking system constructed from steel for reliable strength
- Equipped with right-hand aluminum hinges
- Locking system and hinges certified with ECE R11
- Painted, single body aluminum frame with a painted fiberglass outer panel
- Integrated window with blind to filter light and provide privacy
- Thermoformed, insulated construction for a secure, tight fit

Contact us for requests.

Available options:

- Manual or electric locks
- Standard or low-profile hinges
- Single or double-pane windows
- With or without window
- With or without gas spring
- Exterior panel material options



EASY HANDLE

Entry door | One-point lock

NEW

- One-point locking system constructed from steel for reliable strength
- Equipped with right-hand semi-hidden aluminum hinges
- Locking system and hinges certified with ECE R11
- Painted, single body aluminum frame with a painted fiberglass outer panel
- Integrated double window with blind to filter light and provide privacy
- Thermoformed, insulated construction for a secure, tight fit
- Retractable hanger for a practical coat rack
- Wiring or electric contact
- Aluminum frames with diamond effect surface

Contact us for requests.

Available options:

- Manual or electric locks
- Standard or semi-hidden hinges
- With or without window
- With or without gas spring
- Exterior panel material options



Number of Hinges	↔ Cutout Dimension Ranges		
	↕ H	↕ W	Corner Radius
Available by request only			
2	1.700 mm to 2.000 mm	600 mm to 650 mm	80 mm

Number of Hinges	↔ Cutout Dimension Ranges		
	↕ H	↕ W	Corner Radius
Available by request only			
3	1.920 mm	580 mm	82,5 mm

EASY POCKET

Entry door | One-point lock

- One-point locking system constructed from steel for reliable strength
- Equipped with right-hand aluminum hinges
- Locking system and hinges certified with ECE R11
- Painted, single body aluminum frame with a painted fiberglass outer panel
- Integrated window with blind to filter light and provide privacy
- Thermoformed, insulated construction for a secure, tight fit
- Includes built-in storage pockets

Contact us for requests.

Available options:

- Manual or electric locks
- Standard or low-profile hinges
- Single or double-pane windows
- With or without window
- With or without gas spring
- Exterior panel material options



EASY POCKET 2.0

Entry door | One-point lock

- One-point locking system constructed from steel for reliable strength
- Equipped with right-hand aluminum hinges
- Locking system and hinges certified with ECE R11
- Painted, single body aluminum frame with a painted fiberglass outer panel
- Integrated window with blind to filter light and provide privacy
- Thermoformed, insulated construction for a secure, tight fit
- Includes built-in storage pockets

Contact us for requests.

Available options:

- Manual or electric locks
- Standard or low-profile hinges
- Single or double-pane windows
- With or without window
- With or without gas spring
- Exterior panel material options



Number of Hinges	↔ Cutout Dimension Ranges		
	↕ H	↕ W	Corner Radius
Available by request only			
2	1.900 mm to 1.920 mm	550 mm to 570 mm	80 or 89 mm

Number of Hinges	↔ Cutout Dimension Ranges		
	↕ H	↕ W	Corner Radius
Available by request only			
3	1.740 to 1.750 mm	700 mm to 725 mm	82,5 mm

EASY STORAGE XL

Entry door | One-point lock

- One-point locking system constructed from steel for reliable strength
- Equipped with right-hand aluminum hinges
- Locking system and hinges certified with ECE R11
- Painted, single body aluminum frame with a painted fiberglass outer panel
- Integrated window with blind to filter light and provide privacy
- Thermoformed, insulated construction for a secure, tight fit
- Includes built-in dustbin compartment

Contact us for requests. Available options:

- Manual or electric locks
- Standard or low-profile hinges
- Single or double-pane windows
- With or without window
- With or without gas spring
- Exterior panel material options



Number of Hinges	↔ Cutout Dimension Ranges		
	↕ H	↕ W	Corner Radius
Available by request only			
2	1.900 mm to 1.950 mm	640 mm to 680 mm	80 or 89 mm

TEARDROP

Entry door | One-point lock

- One-point locking system constructed from steel for reliable strength
- Low-profile hinges for a clean look on the outside of the RV
- Locking system and hinges certified with ECE R11
- Painted, single body aluminum frame with a painted fiberglass outer panel
- Integrated window with blind to filter light and provide privacy
- Thermoformed, insulated construction for a secure, tight fit
- Includes built-in storage compartment and lower housing for a fire extinguisher
- Includes two built-in storage pockets and a central magazine rack
- Features two chrome coat hooks for convenience

Contact us for requests. Available options:

- Manual or electric lock
- Single or double-pane windows
- With or without window
- Exterior panel material options
- Single-pane window with silk screen printing



Number of Hinges	↔ Cutout Dimension Ranges		
	↕ H	↕ W	Corner Radius
Available by request only			
3 (semi-concealed)	1.727 mm	660 mm	330 mm

ARJA ROAD

Entry door | Two-point lock

- Electric (standard), two-point, steel locking system constructed from steel for reliable strength
- Equipped with right-hand, nickel-plated brass hinges
- Hidden hinges for a clean look on the outside of the RV
- Locking system and hinges certified with ECE R11
- Painted, single body aluminum frame with a painted fiberglass outer panel
- Electric glass window for easy operation with the press of a button
- Integrated window with flyscreen and blind to filter light and provide privacy
- Thermoformed, insulated construction for a secure, tight fit
- Includes built-in storage compartment

Contact us for requests.
Available options:

- Manual lock
- With or without gas spring
- Exterior panel material options



Number of Hinges	↔ Cutout Dimension Ranges		
	↕ H	↕ W	Corner Radius
Available by request only			
4	1.910 mm to 1.965 mm	590 mm to 685 mm	82,5 mm

ATLANTIC

Entry door | Two-point lock

- Two-point locking system constructed from steel for reliable strength
- Automotive-style brackets assist with opening and hold at various positions
- Hidden hinges for a clean look on the outside of the RV
- Locking system and hinges certified with ECE R11
- Painted, single body aluminum frame with a painted fiberglass outer panel
- Large, trapezoid-shaped glass window for added light and visibility inside the vehicle
- Integrated window with blind to filter light and provide privacy
- Includes built-in storage compartment

Contact us for requests.
Available options:

- Manual or electric locks
- Exterior panel material options



Number of Hinges	↔ Cutout Dimension Ranges		
	↕ H	↕ W	Corner Radius
Available by request only			
7	2.223 mm	849 mm	90 mm

CHIC EVO

Entry door | Two-point lock

- Two-point locking system constructed from steel for reliable strength
- Inner service panel for easy locking system maintenance
- Equipped with right-hand aluminum hinges
- Locking system and hinges certified with ECE R11
- Painted, single body aluminum frame with a painted fiberglass outer panel
- Integrated window with blind to filter light and provide privacy
- Thermoformed, insulated construction for a secure, tight fit
- Includes built-in dustbin compartment
- Comfort handle for ergonomic operation

Contact us for requests.

Available options:

- Manual or electric locks
- Standard or low-profile hinges
- Single or double-pane windows
- With or without gas spring
- Exterior panel material options



CHILL

Entry door | Two-point lock

- Electric (standard), two-point steel locking system constructed from steel for reliable strength
- Inner service panel for easy locking system maintenance
- Lippert lock is UN/ECE R10 certified for safety and reliability
- Equipped with right-hand, nickel-plated brass hinges certified with ECE R11
- Painted, single body aluminum frame with a painted fiberglass outer panel
- Integrated blind to filter light and provide privacy
- Thermoformed, insulated construction for a secure, tight fit
- Includes built-in storage pockets

Contact us for requests.

Available options:

- Manual or electric locks
- Standard or low-profile hinges
- Single or double-pane windows
- With or without window
- With or without gas spring
- Exterior panel material options
- Premium ZAMAK entry handle



Number of Hinges	↔ Cutout Dimension Ranges		
	↕ H	↕ W	Corner Radius
Available by request only			
2	1.920 mm to 2.050 mm	670 mm to 830 mm	80 or 89 mm

Number of Hinges	↔ Cutout Dimension Ranges		
	↕ H	↕ W	Corner Radius
Available by request only			
2	1.700 mm to 2.000 mm	600 mm to 650 mm	80 mm

COOL

Entry door | Two-point lock

- Electric (standard), two-point steel locking system constructed from steel for reliable strength
- Inner service panel for easy locking system maintenance
- Equipped with right-hand aluminum hinges
- Locking system and hinges certified with ECE R11
- Painted, single body aluminum frame with a painted fiberglass outer panel
- Integrated flyscreen and blind to filter light and provide privacy
- Thermoformed, insulated construction for a secure, tight fit
- Includes built-in dustbin compartment

Contact us for requests.

Available options:

- Manual or electric locks
- Standard or low-profile hinges
- Single or double-pane windows
- With or without window
- With or without gas spring
- Exterior panel material options



Number of Hinges	↔ Cutout Dimension Ranges		
	↕ H	↕ W	Corner Radius
Available by request only			
2	1.700 mm to 2.000 mm	600 mm to 650 mm	89 mm

HORIZON

NEW

Entry door | Two-point lock

- Electric (standard), two-point steel locking system constructed from steel for reliable strength
- Inner service panel for easy locking system maintenance
- Equipped with right-hand aluminum hinges
- Locking system and hinges certified with ECE R11
- Painted, single body aluminum frame with a painted fiberglass outer panel
- Integrated flyscreen and blind to filter light and provide privacy
- Thermoformed, insulated construction for a secure, tight fit
- Includes built-in dustbin compartment
- Wide window and horizontal handle
- Aluminum inner handle

Contact us for requests.

Available options:

- Manual or electric locks
- Standard or low-profile hinges
- Single or double-pane windows
- Exterior panel material options



Number of Hinges	↔ Cutout Dimension Ranges		
	↕ H	↕ W	Corner Radius
Available by request only			
2	1.920 mm	650 mm	89 mm

MODULARIA

Entry door | Two-point lock

- Electric (standard), two-point steel locking system constructed from steel for reliable strength
- Equipped with left or right-hand aluminum hinges
- Locking system and hinges certified with ECE R11
- Painted, single body aluminum frame with a painted fiberglass outer panel
- Integrated flyscreen and blind to filter light and provide privacy
- Thermoformed, insulated construction for a secure, tight fit
- Includes built-in dustbin compartment
- Aluminum inner handle

Contact us for requests.

Available options:

- Manual or electric locks
- Standard or low-profile hinges
- Single or double-pane windows
- With or without window
- With or without gas spring
- Exterior panel material options
- Pocket, trash-bin and corner finishing options

NEW

NEWY

Entry door | Two-point lock

- Electric (standard), two-point steel locking system constructed from steel for reliable strength
- Inner service panel for easy locking system maintenance
- Equipped with left-hand aluminum hinges
- Locking system and hinges certified with ECE R11
- Painted, single body aluminum frame with a painted fiberglass outer panel
- Integrated window with blind to filter light and provide privacy
- Thermoformed, insulated construction for a secure, tight fit
- Includes built-in dustbin compartment
- Wide window and horizontal handle

Contact us for requests.

Available options:

- Manual or electric locks
- Standard or low-profile hinges
- Single or double-pane windows
- Exterior panel material options

NEW



Number of Hinges	↔ Cutout Dimension Ranges		
	↕ H	↕ W	Corner Radius
Available by request only			
2	1.920 mm	650 mm	89 mm

Number of Hinges	↔ Cutout Dimension Ranges		
	↕ H	↕ W	Corner Radius
Available by request only			
2	1.920 mm	650 mm	89 mm

TRENDY

Entry door | Two-point lock

- Two-point locking system constructed from steel for reliable strength
- Available with a left or right-hand handle
- Equipped with left or right-hand aluminum hinges
- Locking system and hinges certified with ECE R11
- Painted, single body aluminum frame with a painted fiberglass outer panel
- Integrated window with blind to filter light and provide privacy
- Thermoformed, insulated construction for a secure, tight fit
- Includes built-in dustbin compartment

Contact us for requests.

Available options:

- Manual or electric locks
- Standard or low-profile hinges
- Single or double-pane windows
- With or without gas spring
- Exterior panel material options



Number of Hinges	↔ Cutout Dimension Ranges		
	↕ H	↕ W	Corner Radius
Available by request only			
2	1.905 to 1.950 mm (left) / 1.960 mm (right)	550 mm to 657 mm	80 or 89 mm

TRENDY SMALL

Entry door | Two-point lock

- Two-point locking system constructed from steel for reliable strength
- Equipped with right-hand aluminum hinges
- Locking system and hinges certified with ECE R11
- Painted, single body aluminum frame with a painted fiberglass outer panel
- Integrated window with blind to filter light and provide privacy
- Thermoformed, insulated construction for a secure, tight fit
- Includes built-in dustbin compartment
- Premium brushed aluminum handle

Contact us for requests.

Available options:

- Manual or electric locks
- Standard or low-profile hinges
- Single or double-pane windows
- With or without gas spring
- Exterior panel material options



Number of Hinges	↔ Cutout Dimension Ranges		
	↕ H	↕ W	Corner Radius
Available by request only			
2	1.740 mm to 1.945 mm	550 mm to 588 mm	80 or 89 mm

TRENDY WAVE

Entry door | Two-point lock

- Two-point locking system constructed from steel for reliable strength
- Inner service panel for easy locking system maintenance
- Equipped with right-hand aluminum hinges
- Locking system and hinges certified with ECE R11
- Painted, single body aluminum frame with a painted fiberglass outer panel
- Integrated window with blind to filter light and provide privacy
- Thermoformed, insulated construction for a secure, tight fit
- Includes built-in storage pockets

Contact us for requests.

Available options:

- Manual or electric locks
- Standard or low-profile hinges
- Single or double-pane windows
- With or without window
- With or without gas spring
- Exterior panel material options



DOVETAIL

NEW

Driver door | Two-point lock

- Two-point locking system constructed from steel for reliable strength
- Equipped with hidden, left-hand aluminum hinges for a clean look
- ECE R11 certified locking system and hinges
- Painted, single body aluminum frame with a painted fiberglass outer panel
- Electric glass window for easy operation with the press of a button
- ECE R43 certified window is integrated with a blind to filter light and provide privacy
- Thermoformed, insulated construction for a secure, tight fit
- LED light illuminates the ground for secure access
- Joystick mirror for easy adjustment of view (mirror not included)
- Includes built-in pocket storage
- Automotive-style brackets assist with opening and hold at various positions

Contact us for requests.

Available options:

- Manual or electric locks
- With or without gas spring
- Exterior panel material options
- Double-glazed window



Number of Hinges	↔ Cutout Dimension Ranges		
	↕ H	↕ W	Corner Radius
Available by request only			
2	1.895 mm to 1.970 mm	635 mm to 710 mm	80 or 89 mm

Number of Hinges	↔ Cutout Dimension Ranges		
	↕ H	↕ W	Corner Radius
Available by request only			
3	1.613 mm	719 mm	82,5 mm



SIMPLY TRAIL

NEW

Trailer door | One-point lock

- One-point locking system constructed from steel for reliable strength
- Equipped with semi-hidden left or right-hand aluminum hinges
- Painted, single body aluminum frame with a painted fiberglass outer panel
- Thermoformed, insulated construction for a secure, tight fit

**Contact us for requests.
Available options:**

- With or without window blind
- With or without dustbin
- With or without object holder
- Stable door version



DOORS & SERVICE DOORS

Number of Hinges	↔ Cutout Dimension Ranges		
	↕ H	↕ W	Corner Radius
Available by request only			
2	1.700 to 1.900 mm	550 mm to 600 mm	89 mm

SERVICE DOOR FRAMES

- Extruded aluminum frame construction
- Compatible with 22 mm to 42 mm thick panels
- One-point or two-point locking system
- Includes service door frame only (panels sold separately)
- Equipped with right and left-hand aluminum hinges

Contact us for requests.
Available options:

- Manual or electric locks
- Standard or low-profile hinges
- Internal / external frame panel slot ranges: 22 mm to 42 mm
- Fiberglass material

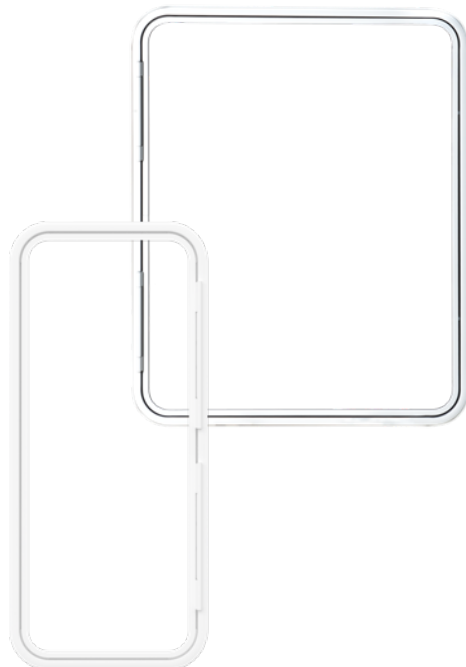

Frame Dimensions		↕ Hinge position (side)
↕ H	↔ W	
Available by request only		
300 mm to 900 mm	300 mm to 1.900 mm	350 mm to 1.900 mm





DOOR COLOR OPTIONS**

External frame profiles

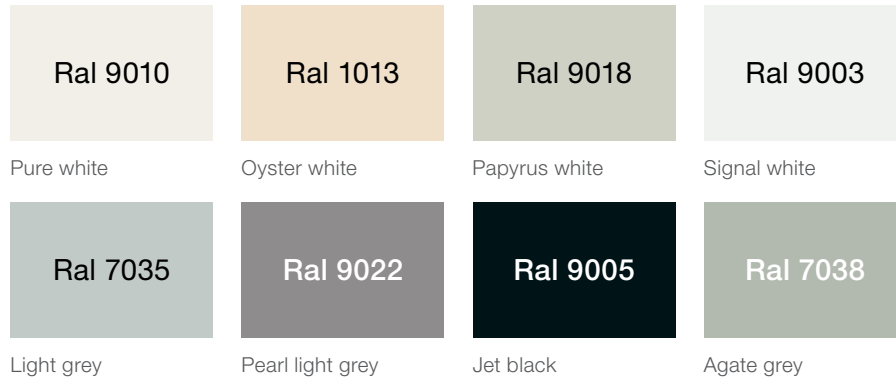

External door panels (fiberglass)

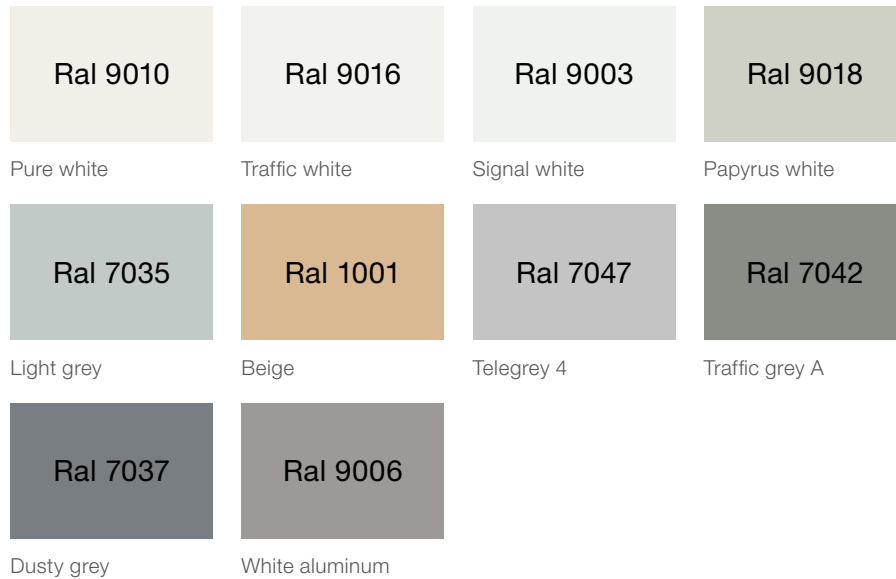

External door panels (aluminum)



Internal thermoformed main panels



Internal thermoformed accent panels

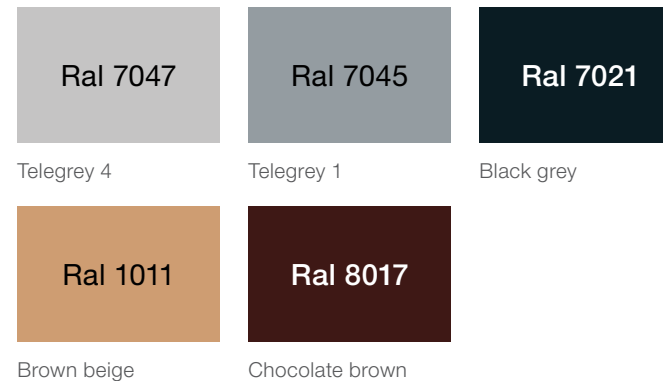

** Color swatches are representative only. Please call for exact color specifications.

COMPLETE SERVICE DOOR

Configuration options - available on request only

1. Aluminum Profile

Internal options



22 - 25 mm 26 - 32 mm 33 - 42 mm

External options



22 - 25 mm 26 - 32 mm 33 - 42 mm

Radius options

- 80 mm or 89 mm

Profile color options** (internal and external)

Ral 9010	Ral 9003	Ral 9001	Ral 7035
Pure white	Signal white	Cream	Light grey

2. Fiberglass Panel Color Options*

Internal and external**

Ral 9003

Signal white

3. Locking System

Screw lock



Magic lock



** Color swatches are representative only. Please call for exact color specifications.

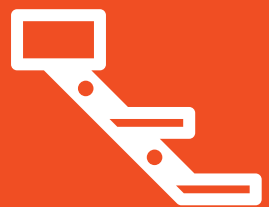

STEPS





Our broad range of caravan and motorcaravan steps are available in steel, aluminum, and hi-tech polymer with manual and power configuration options to suit every need. We offer single, double, and triple entry steps for caravans and motorcaravans.

ALANERA

Slide-out step | Electric

- High-power 12V motor
- Automatic slide-out motion for a safe, comfortable, unobtrusive step
- Lightweight yet durable construction with high-tech, injection molded polymer
- Weatherproof and tested for the outdoors
- Integrated motor sensor for 'open step' warning
- Integrated thermal breaker in case of excessive strain
- Includes manual, quick-release emergency system
- Anti-slip finish for safe entry and exit
- Side wings help integrate the step with the vehicle and can support a person's weight
- Automotive-quality finish for lasting resilience to the elements
- Easy to clean – simply spray off with a hose
- Installation wiring cables included with electric models
- Installation kits available for: Fiat Ducato, Citroen Jumper, Peugeot Boxer and Ford Transit



Closed



Open



Sleek, modern design to complement modern caravans and motorcaravans



Unique drain channels and anti-slip finish help keep the tread clean in any weather

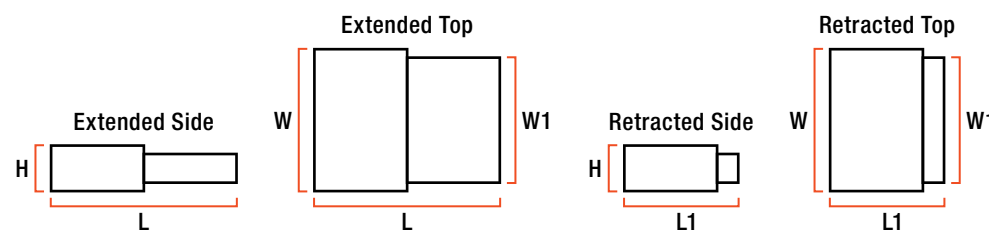

Part #	Includes	↕ H	↕ W	↕ W1	↕ L	↕ L1	📦	📦	⚡
2021136174	Step and lateral wings (installation kits sold separately)	85 mm	562 mm	550 mm	692 mm	445 mm	5,9 kg	200 kg	2,5 A

INNOLIGHT V6

Slide-out step | Electric

- High-power 12V motor
- 'C' aluminum profile guides reduce weight and increase efficiency during installation and performance
- Ergonomic footboard and side cover design
- Front covers available to integrate the step with the vehicle
- Lightweight yet durable mixed plastic, steel and aluminum construction
- Weatherproof and tested for the outdoors
- Integrated motor sensor for 'open step' warning
- Integrated thermal breaker in case of excessive strain
- Includes manual, quick-release emergency system
- Anti-slip tape for safe entry and exit
- Anodized aluminum with a black, painted finish for strong corrosion protection (finish requires proper handling to maintain appearance)
- Sturdy, one body anodized aluminum footboard for lasting corrosion resistance and noise reduction
- Installation wiring cables included
- Installation kits available for Fiat Ducato, Citroen Jumper, Peugeot Boxer, Ford Transit, and Volkswagen Crafter



STEPS



Lightweight, durable plastic, steel, and aluminum construction with anti-slip surface for safe stepping



Front covers available to integrate the step with the vehicle for a clean, seamless look

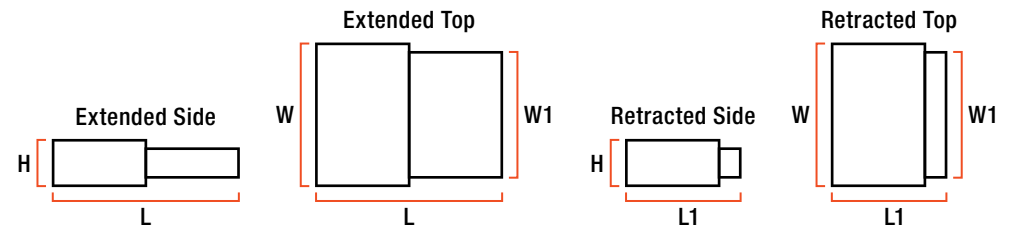

Part #	↕ H	↕ W	↕ W1	↕ L	↕ L1	📦	📦	⚡
2023038712	82,3 mm	572 mm	550 mm	690 mm	433 mm	7,8 kg	200 kg	17 A

R-SERIES V2

NEW

Tilting step | Electric or manual

- Designed for RV application with standard chassis height
- High-power 12V motor for tilting movement in 1,5 seconds (electric version only)
- Steel frame with lightweight aluminum board for stability in all conditions
- Galvanized and painted finishes for strong corrosion protection
- Anti-shock clutch protects motor and gearbox while step is in motion
- Sensor integrated in the motor cover for 'open step' warning
- Integrated thermal breaker in case of excessive strain
- Installation wiring cables included with electric models
- Optional IP44 motor case



Electric model



Anti-slip rubber for safe entry and exit

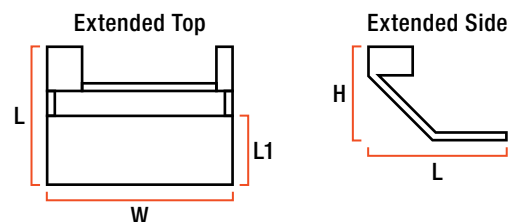

Operation	↕ H	↔ W	↕ L	↕ L1	📦	📦	⚡
Available by request only							
Electric	229 mm	350 mm to 750 mm	507 mm	200 mm	5,3 kg to 6,1 kg	200 kg	2,5 A
Manual	229 mm	350 mm to 750 mm	507 mm	200 mm	3,7 kg to 4,2 kg	200 kg	--

S-SERIES V2

NEW

Tilting step | Electric

- Designed for RV application with low-profile chassis
- High-power 12V motor for tilting movement in 1,5 seconds
- Anti-shock clutch protects motor and gearbox while step is in motion
- Steel frame with lightweight aluminum board for stability in all conditions
- Galvanized and painted finishes for strong corrosion protection
- Integrated motor sensor for 'open step' warning
- Integrated thermal breaker in case of excessive strain
- Installation wiring cables included
- Optional IP44 motor case



STEPS



Anti-slip rubber for safe entry and exit

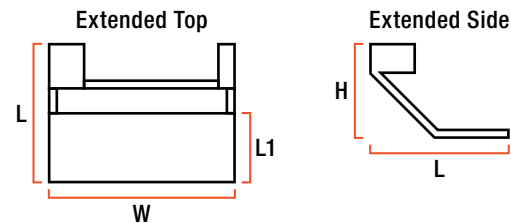

Operation	↕ H	↔ W	↔ L	↔ L1	📦	📦	⚡
Available by request only							
Electric	144 mm	350 mm to 750 mm	564 mm	200 mm	5,5 kg to 6,0 kg	200 kg	2,5 A

T-SERIES V2

NEW

Tilting step | Electric or manual

- Designed for caravan applications
- High-power 12V motor for tilting movement in 1,5 seconds (electric version only)
- Anti-shock clutch protects motor and gearbox while step is in motion
- Steel frame with lightweight aluminum board for stability in all conditions
- Galvanized and painted finishes for strong corrosion protection
- Sensor integrated in the motor cover for 'open step' warning
- Integrated thermal breaker in case of excessive strain
- Installation wiring cables included with electric models
- Optional IP44 motor case



Electric model

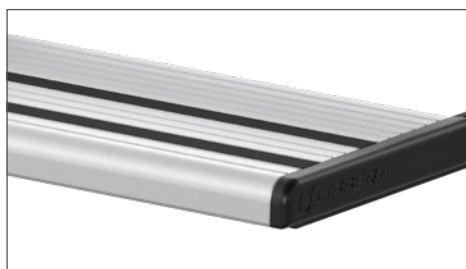

Anti-slip rubber for safe entry and exit

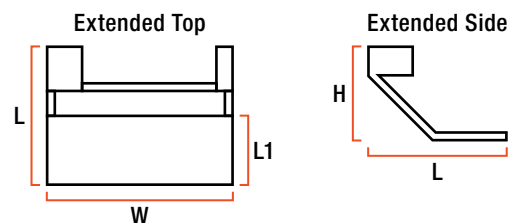

Operation	↕ H	↔ W	↔ L	↔ L1	📦	📦	⚡
Available by request only							
Electric	210 mm	350 mm to 750 mm	486 mm	200 mm	5,5 kg to 6,2 kg	200 kg	2,5 A
Manual	210 mm	350 mm to 750 mm	486 mm	200 mm	3,6 kg to 4,7 kg	200 kg	--

J-SERIES

Retractable step | Electric

- Two-step configuration for easy, ergonomic access
- High-power 12V motor
- J-series features increased step riser
- Anti-slip EPDM rubber for safe entry and exit
- Steel frame with lightweight aluminum board for stability in all conditions
- Sturdy, anodized aluminum footboard for lasting corrosion resistance
- Galvanized and painted finishes for strong corrosion protection
- Multifunction electronic control unit for total control of all step functions
- Waterproof connectors and sensors
- Includes manual, quick-release emergency system
- Motor protection system in case of excessive stress



STEPS

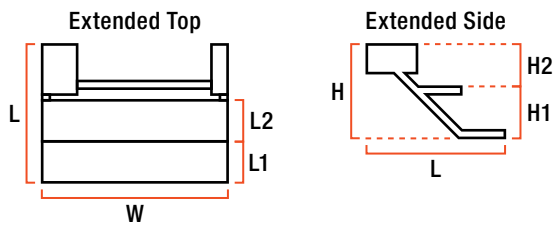

Part #	↕ H	↕ H1	↕ H2	↕ W	↕ L	↕ L1	↕ L2	🛒	🛒	⌛
2023038711	450 mm	127 mm	228 mm	610 mm	915 mm	203 mm	255 mm	58 kg	200 kg	5 A

U-SERIES

Fold-out step | Electric

- Three-step configuration for easy, ergonomic access
- High-power 12V motor
- Anti-slip EPDM rubber for safe entry and exit
- Sturdy, anodized aluminum footboard for lasting corrosion resistance
- Galvanized and painted finishes for strong corrosion protection
- Multifunction electronic control unit for total control of all step functions
- Automatically closes when engine starts
- Warning light for 'open step' sensor
- Left or right motor option to accommodate either side of the RV
- Includes manual, quick-release emergency system
- Motor protection system in case of excessive stress

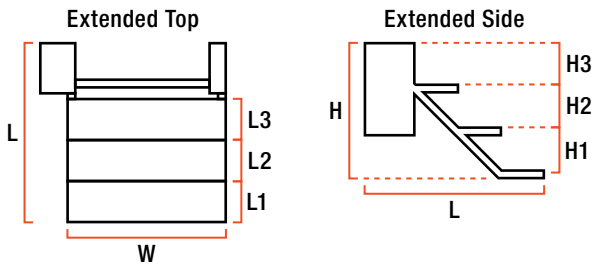

Part #	Motor	↕ H	↕ H1	↕ H2	↕ H3	↕ W	↕ L	↕ L1	↕ L2	↕ L3	📦	📦	⚡
2021104042	On right side	627 mm	223 mm	222 mm	182 mm	550 mm	1.154 mm	200 mm	200 mm	200 mm	29 kg	200 kg	5 A
2021104067	On left side	627 mm	223 mm	222 mm	182 mm	550 mm	1.154 mm	200 mm	200 mm	200 mm	29 kg	200 kg	5 A
2021104035	On right side	627 mm	223 mm	222 mm	182 mm	645 mm	1.154 mm	200 mm	200 mm	200 mm	33 kg	200 kg	5 A
2021104023	On left side	627 mm	223 mm	222 mm	182 mm	645 mm	1.154 mm	200 mm	200 mm	200 mm	33 kg	200 kg	5 A

U2-SERIES

Fold-out step | Electric

- Three-step configuration for easy, ergonomic access
- High-power 12V motor
- Anti-slip EPDM rubber for safe entry and exit
- Sturdy, anodized aluminum footboard for lasting corrosion resistance
- Galvanized and painted finishes for strong corrosion protection
- Multifunction electronic control unit for total control of all step functions
- Automatically closes when engine starts
- Warning light for 'open step' sensor
- Includes manual, quick-release emergency system
- Motor protection system in case of excessive stress

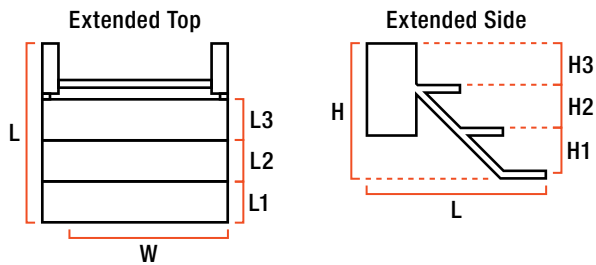

Part #	Motor	↕ H	↕ H1	↕ H2	↕ H3	↕ W	↕ L	↕ L1	↕ L2	↕ L3	📦	📦	⌚
2021104054	--	656 mm	240 mm	240 mm	140 mm	640 mm	1.245 mm	200 mm	200 mm	200 mm	72,9 kg	200 kg	5 A

STEP ACCESSORIES



2021104025

Relè

- Makes system completely automatic with the opening or closing of the door
- Compatible with all Lippert electric steps



2021104055



2021104094

Switch and Switch cover

- Rocker switch to open or close electric steps
- Compatible with all Lippert electric steps
- Cover provides a clean, finished look on the #2021104055 switch (cover sold separately)



2021104044

Closy

- Enables automatic storing of electric steps when starting the vehicle's engine
- Prevents steps from opening while driving
- Compatible with Alanera and Innolight steps



2022003626



2022110289

Elektra.Plus control units

- Reduced size and integrated light timer
- See table for step compatibility



Elektra control unit

- Available in bundle with Relè, see below
- Compatible with all Lippert electric steps

Part #	Description	Compatibility
2021104025	RELÈ	All Lippert electric steps
2021104055	SWITCH	All Lippert electric steps
2021104094	SWITCH COVER	Open / close switch
2021104044	CLOSY	Alanera and Innolight steps

Part #	Description	Compatibility
2022003626	ELEKTRA.PLUS control unit	Alanera and Innolight steps
2022110289	ELEKTRA.PLUS control unit	Lippert R-, S-, T- and L-series steps
Varies by step model	ELEKTRA control unit	All Lippert electric steps



SPOT

Heavy-duty step stool

- Commonly used in caravans
- Tough plastic construction
- Grated top surface keeps step clear of debris
- Colors customizable on request according to quantities



2021104068

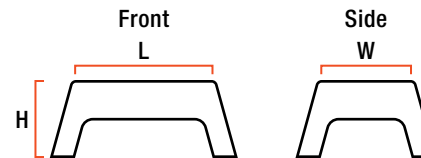

Part #	↕ H	↔ W	↔ L	📦	📦
2021104068	250 mm	350 mm	470 mm	2,6 kg	150 kg
2021104024	220 mm	260 mm	410 mm	1,0 kg	150 kg
2021104036	230 mm	280 mm	460 mm	1,4 kg	150 kg

MAX LOAD 📦

PRODUCT WEIGHT 📦

DIMENSION ↕

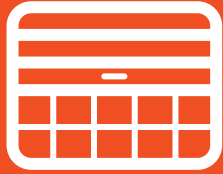

BLINDS & FLYSCREENS





Shut out the harsh sunlight and get a bug-free, peaceful ambiance inside your caravan or campervan with Lippert window blind systems. We offer a complete selection of various sizes, styles, and functional designs. Some are compatible with our window systems too.

SKIA

Blind | Polymer

- Retractable, pleated blind to keep vehicle interior blacked-out for privacy while parked
- Fireproof fabric options are available upon request
- See the table below for vehicle-specific configurations

Color options*

Ral 1013

Oyster white
(Available upon request)

Ral 7035

Light grey



Retractable, pleated blind to keep vehicle interior blacked-out while parked



Provides interior privacy as needed



PVC and aluminum handle for manual operation

Fits Van	Name	Location	Includes	Light Grey Part #	Oyster White Part #
Fiat DUCATO X290 / V8	SKIA FRONT	Windshield	Blind only	2023038700	Available upon request
Fiat DUCATO X290 / V8	SKIA FRONT	Windshield	Blind with mirror compartment	2023038701	
Fiat DUCATO X290	SKIA FRONT	Windshield	Blind with mirror compartment and sensor	2023038702	
Fiat DUCATO X290	SKIA SIDE	Driver and passenger windows	Left- and right-side blinds	2023038703	
Fiat DUCATO V8	SKIA FRONT	Windshield	Blind with mirror compartment and sensor	2023038704	
Fiat DUCATO V8	SKIA SIDE	Driver and passenger windows	Left- and right-side blinds	2023038705	

SKIA PRIVACY

SKIA Accessory | Windshield blind

- Attaches to the bottom of SKIA windshield blind to block all light from entering the vehicle cabin



2023038718

Part #	Fits
2023038718	All SKIA models

SKIA SPACER

SKIA Accessory | Van sun visors

- Provides additional space for the sun visor to be utilized while SKIA is installed
- Installs under the existing sun visor pivot cover



Left - Driver



Right - Passenger



Installs under the existing sun visor pivot cover



Provides additional space for the sun visor to be utilised while SKIA is installed

Part #	Color	Location
2023038709	Light grey (RAL 7035)	Driver / left
2023038710	Light grey (RAL 7035)	Passenger / Right

ELARA

Motorcaravan door flyscreen

- PVC sliding flyscreen with walkable, U-shaped guide provides a versatile solution for motorcaravan doors
- Clutched sliding system allows the screen to be opened to any position
- Keeps out flies, mosquitoes, and debris while allowing fresh airflow
- Adaptable at different distances from the van wall
- Fireproof fabric options are available upon request

Color option*

Ral 9010

Pure white

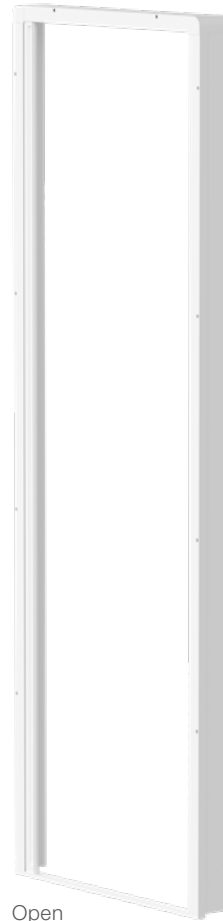

Open



↔ Cutout Dimension Ranges

↕ H

↕ L

Available by request only

1.490 mm to 2.000 mm

565 mm to 965 mm

VANSCREEN

Flyscreen | Aluminum

- Aluminum sliding flyscreen with flat, L-shaped guide provides a versatile solution to fit a variety of layouts
- Clutched sliding system allows the screen to be opened to any position
- Keeps out flies, mosquitoes, and debris while allowing fresh airflow
- Vanscreen should be left open while van door is closed to avoid obstruction
- Works independently of the sliding door
- Right-hand door option is available upon request
- Fireproof fabric options are available upon request

Color option*

Ral 9005

Jet black



Keeps out insects and debris while allowing fresh airflow



Clutched sliding system allows the screen to be opened to any position

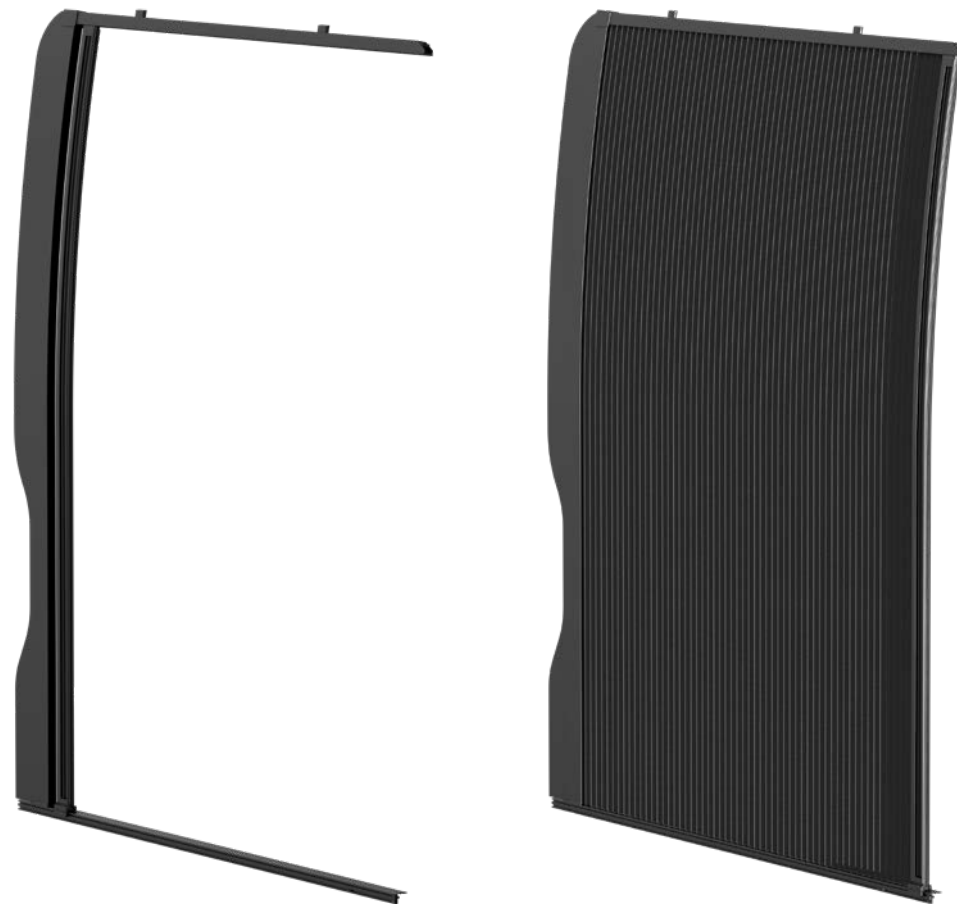

BLINDS & FLYSCREENS

Part #	Fits Van	Location	↕ H	↕ W
2023038707	Fiat DUCATO X250 / X290 / V8	Right-hand door only	1.708 mm	1.295 mm

*Color swatches are representative only. Please call for exact color specifications.

HYDRA

Skylight blind

- Manual sliding system with spring-assist for easier operation
- Clutched sliding mechanism allows for easy opening to any position
- Strong, lightweight aluminum frame construction
- Retractable, pleated blind to help filter light and provide privacy
- Mesh screen keeps out flies, mosquitoes, and debris while allowing fresh airflow
- Integrated aluminum handle for easy operation
- White inner fabric with silver-colored outer side
- Fireproof fabric options are available upon request

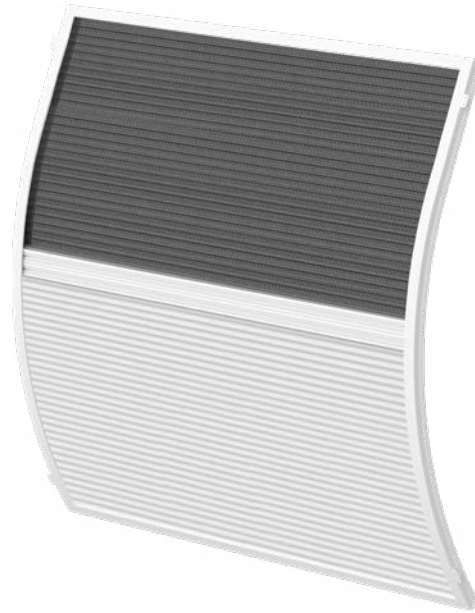

Profile curve radius

Color option*

Ral 9010

Pure white

↔ Blind Dimension Ranges		↔ Cutout Dimension Ranges		
↕ Height	↕ Width	↕ Height	↕ Width	Profile Curvature Radius
Available by request only				
380 mm to 1.330 mm	340 mm to 2.090 mm	250 mm to 1.200 mm	250 mm to 2.000 mm	350 mm+

WINDOW COMPATIBILITY

For blinds and flyscreens

If you are looking for a complete window system, our compatibility chart will help you pair our blinds and flyscreens with the corresponding window.

See page 20 for more information about windows.



Slide



Aero



Curved

Blinds & Flyscreens		Aluminum Framed Window Systems		
Name	Material	Poly. Slide	Poly. Aero	Poly. Curved
Wall Thickness Comparison				
Pluto	Aluminum	≥ 25 mm	≥ 25 mm	≥ 25 mm
Vega	PVC	≥ 28 mm	≥ 28 mm	No
Sirius	PVC	≥ 43 mm	≥ 43 mm	No
Sirius Open	PVC	≥ 43 mm	≥ 43 mm	No
Altair	PVC	≥ 25 mm	≥ 25 mm	No
Altair Open	PVC	≥ 43 mm	≥ 43 mm	No

*Color swatches are representative only. Please call for exact color specifications.

MARS EVO

NEW

Pleated blind and flyscreen | Aluminum

- New design and improved functionality
- New strings adjusting system allows to regulate without removing the blind from the wall (patent pending)
- Profile curvature is customizable for curved-wall vans
- Fixing points on the angles (no holes and caps on the frame)
- Clutched sliding mechanism allows for easy opening to any position
- Available in combo or single fabric (only screen / only blind)
- Lightweight aluminum frame with retractable pleated blind to help filter light and provide privacy
- Mesh screen keeps out flies, mosquitoes, and debris while allowing fresh airflow
- Integrated aluminum handle for easy operation
- Heavy-duty ABS locking clip for improved security
- Fireproof fabric options are available upon request
- For window compatibility, see the comparison chart on page 70



BLINDS & FLYSCREENS

Color option*

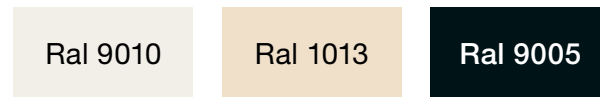

Pure white Oyster white Jet black



Profile curve radius

↔ Blind Dimension Ranges		↔ Cutout Dimension Ranges		
↕ H	↕ W	↕ H	↕ W	Profile Curvature Radius
Available by request only				
380 mm to 1.330 mm	340 mm to 2.090 mm	250 mm to .200 mm	250 mm to 2.000 mm	5.000 mm

*Color swatches are representative only. Please call for exact color specifications.

PLUTO

Pleated blind and flyscreen | Aluminum

- Manual sliding system provides a bold-profile solution with spring-assist for easier operation
- Clutched sliding mechanism allows for easy opening to any position
- Lightweight aluminum frame with retractable blind to help filter light and provide privacy
- Mesh screen keeps out flies, mosquitoes, and debris while allowing fresh airflow
- Integrated aluminum handle for easy operation
- Heavy-duty ABS locking clip for improved security
- Profile curvature is customizable for curved-wall vans
- Fireproof fabric options are available upon request
- For window compatibility, see the comparison chart on page 70

Color option*

Ral 7035	Ral 1013
Light grey	Oyster white (available upon request)



Part #	Blind Dimensions		Cutout Dimensions		
	↕ H	↔ W	↕ H	↔ W	Profile Curvature (Radius)
Flat					
2022112346	485 mm	1.190 mm	350 mm	1.100 mm	--
2022112347	835 mm	1.290 mm	700 mm	1.200 mm	--

Part #	Blind Dimensions		Cutout Dimensions		
	↕ H	↔ W	↕ H	↔ W	Profile Curvature (Radius)
Curved					
2022112348	635 mm	580 mm	500 mm	490 mm	5.000 mm
2022112349	535 mm	890 mm	400 mm	800 mm	5.000 mm

*Color swatches are representative only. Please call for exact color specifications.

VEGA

Pleated blind and flyscreen | Polymer

- Manual sliding system provides a bold-profile solution with spring-assist for easier operation
- Clutched sliding mechanism allows for easy opening to any position
- Constructed with a lightweight, durable PVC frame and polyester fabric blinds
- Retractable, pleated blind to help filter light and provide privacy
- Mesh screen keeps out flies, mosquitoes, and debris while allowing fresh airflow
- Integrated aluminum handle for easy operation
- Compatible with all vehicles that have flat walls
- Fireproof fabric options are available upon request
- For window compatibility, see the comparison chart on page 70

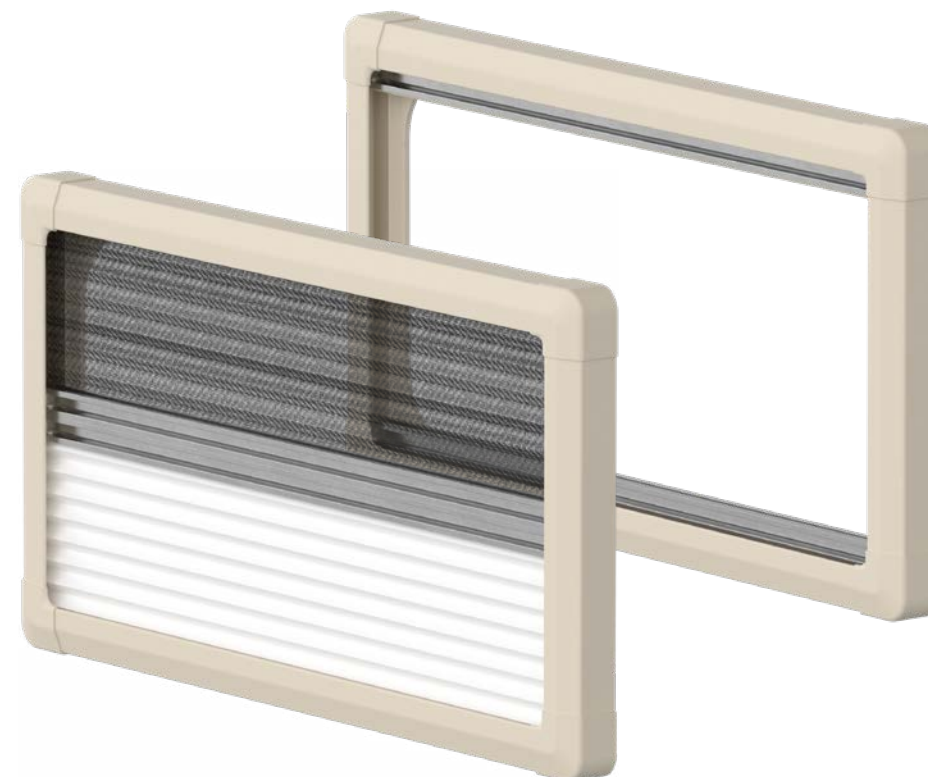

BLINDS & FLYSCREENS

Ral 1013

Oyster white

Part #	Blind Dimensions		Cutout Dimensions	
	↕ H	↕ W	↕ H	↕ W
2021104436	409 mm	459 mm	350 mm	400 mm
2021104444	359 mm	559 mm	300 mm	500 mm
2021104421	509 mm	559 mm	450 mm	500 mm
2021104417	559 mm	559 mm	500 mm	500 mm
2021104425	579 mm	609 mm	520 mm	550 mm
2021104456	559 mm	659 mm	500 mm	600 mm
2021104437	609 mm	659 mm	550 mm	600 mm
2021104426	659 mm	659 mm	600 mm	600 mm
2021104422	559 mm	759 mm	500 mm	700 mm

Part #	Blind Dimensions		Cutout Dimensions	
	↕ H	↕ W	↕ H	↕ W
2021104418	609 mm	759 mm	550 mm	700 mm
2021104427	659 mm	759 mm	600 mm	700 mm
2021104419	559 mm	859 mm	500 mm	800 mm
2021104428	609 mm	859 mm	550 mm	800 mm
2021104548	659 mm	859 mm	600 mm	800 mm
2021104579	359 mm	959 mm	300 mm	900 mm
2021104582	559 mm	959 mm	500 mm	900 mm
2021104585	609 mm	959 mm	550 mm	900 mm
2021104607	659 mm	959 mm	600 mm	900 mm

Part #	Blind Dimensions		Cutout Dimensions	
	↕ H	↕ W	↕ H	↕ W
2021104570	559 mm	1.059 mm	500 mm	1.000 mm
2021104588	659 mm	1.059 mm	600 mm	1.000 mm
2021104573	559 mm	1.159 mm	500 mm	1.100 mm
2021104580	659 mm	1.159 mm	600 mm	1.100 mm
2021104549	359 mm	1.259 mm	300 mm	1.200 mm
2021104583	559 mm	1.259 mm	500 mm	1.200 mm
2021104589	659 mm	1.259 mm	600 mm	1.200 mm
2021104574	559 mm	1.359 mm	500 mm	1.300 mm
2021104571	659 mm	1.359 mm	600 mm	1.300 mm

*Color swatches are representative only. Please call for exact color specifications.

SIRIUS

Pleated blind and flyscreen | Polymer

- Clutched sliding mechanism allows for easy opening to any position
- Constructed with a lightweight, durable PVC frame and polyester fabric blinds
- Retractable, pleated blind to help filter light and provide privacy
- Mesh screen keeps out flies, mosquitoes, and debris while allowing fresh airflow
- Integrated aluminum handle for easy operation
- Slim-profile solution compatible with all vehicles that have flat walls
- Fireproof fabric options are available upon request
- For window compatibility, see the comparison chart on page 70

Color options*

Ral 9010	Ral 1013	Ral 9005	Ral 9016
Pure white	Oyster white	Jet black	Grey (fabric)



Part #	Color	Blind Dimensions		Cutout Dimensions	
		↕ H	↔ W	↕ H	↔ W
2022112345	Pure white	481 mm	832 mm	381 mm	762 mm
2022112343	Pure white	620 mm	1.370 mm	520 mm	1.300 mm
2022112342	Pure white	608 mm	832 mm	508 mm	762 mm
2022111917	Oyster white	650 mm	670 mm	550 mm	600 mm
2022112344	Pure white	610 mm	1.370 mm	510 mm	1.300 mm

Part #	Color	Blind Dimensions		Cutout Dimensions	
		↕ H	↔ W	↕ H	↔ W
2022111918	Oyster white	390 mm	770 mm	290 mm	700 mm
2022112340	Jet black	714 mm	670 mm	614 mm	600 mm
2022112338	Oyster white	610 mm	1.370 mm	510 mm	1.300 mm
2022112341	Jet black	337 mm	657 mm	237 mm	587 mm
2022112339	Oyster white	475 mm	920 mm	375 mm	850 mm

SIRIUS OPEN

NEW

Pleated blind and flyscreen | Polymer

- Sirius with three sides
- Ideal for small spaces like the bathroom window
- Available in combo or single fabric (only screen / only blind)
- Clutched sliding mechanism allows for easy opening to any position
- Constructed with a lightweight, durable PVC frame and polyester fabric blinds
- Retractable, pleated blind to help filter light and provide privacy
- Mesh screen keeps out flies, mosquitoes, and debris while allowing fresh airflow
- Integrated aluminum handle for easy operation
- Slim-profile solution compatible with all vehicles that have flat walls
- Fireproof fabric options are available upon request
- For window compatibility, see the comparison chart on page 70



BLINDS & FLYSCREENS

Color option*

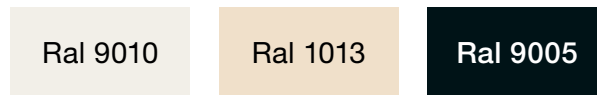

Pure white

Oyster white

Jet black

↔ Blind Dimension Ranges		↔ Cutout Dimension Ranges	
↕ H	↕ W	↕ H	↕ W
Available by request only			
365 mm to 1.015 mm	320 mm to 1.370 mm	250 mm to 900 mm	250 mm to 1.300 mm

*Color swatches are representative only. Please call for exact color specifications.

ALTAIR

NEW

Roller blind and flyscreen | Polymer

- New rolled blind with compact and functional design
- Constructed with a lightweight, durable PVC frame and polyester fabric blinds
- Rolling and sliding system made with lightweight and durable aluminum
- Clutched sliding mechanism allows for easy opening to any position
- Available in combo or single fabric (only screen / only blind)
- Retractable rolled blind to help filter light and provide privacy
- Mesh screen keeps out flies, mosquitoes, and debris while allowing fresh airflow
- Integrated aluminum handle for easy operation
- For window compatibility, see the comparison chart on page 70

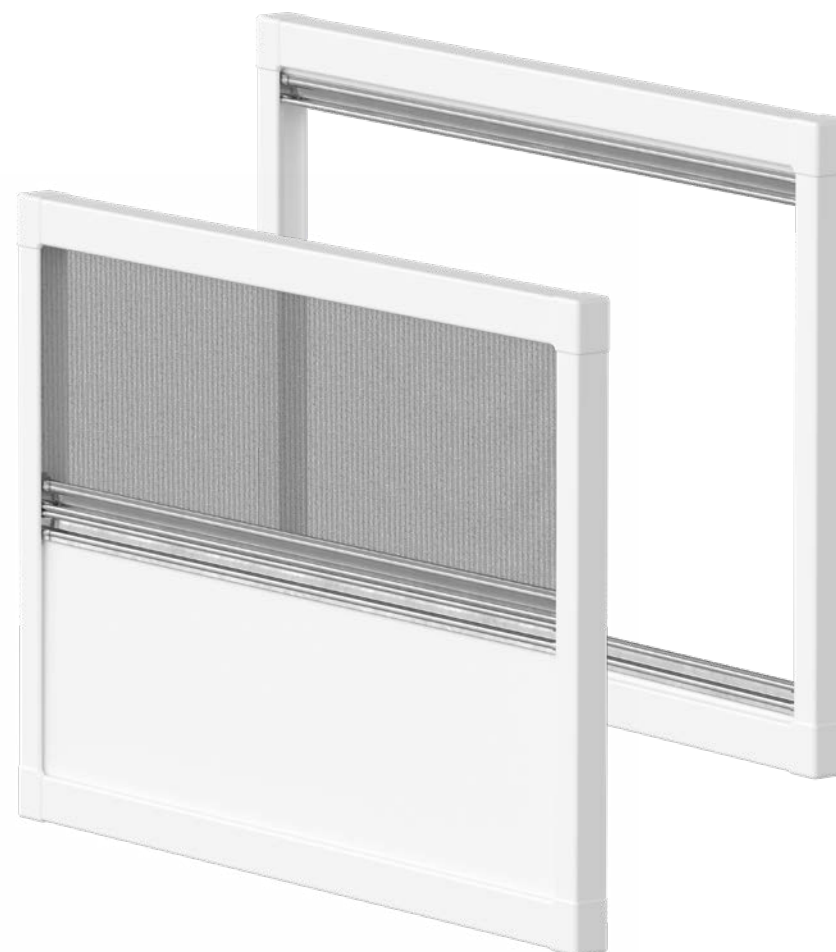

Color options*

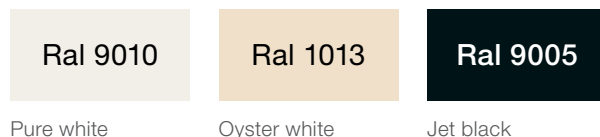

↔ Blind Dimension Ranges		↔ Cutout Dimension Ranges	
↕ H	↕ W	↕ H	↕ W
Available by request only			
421 mm to 1.071 mm	338 mm to 1.888 mm	250 mm to 900 mm	250 mm to 1.800 mm

ALTAIR OPEN

NEW

Roller blind and flyscreen | Polymer

- New rolled blind with three sides and compact, functional design
- Constructed with a lightweight, durable PVC frame and polyester fabric blinds
- Rolling and sliding system made with lightweight and durable aluminum
- Clutched sliding mechanism allows for easy opening to any position
- Available in combo or single fabric (only screen / only blind)
- Retractable rolled blind to help filter light and provide privacy
- Mesh screen keeps out flies, mosquitoes, and debris while allowing fresh airflow
- Integrated aluminum handle for easy operation
- For window compatibility, see the comparison chart on page 70

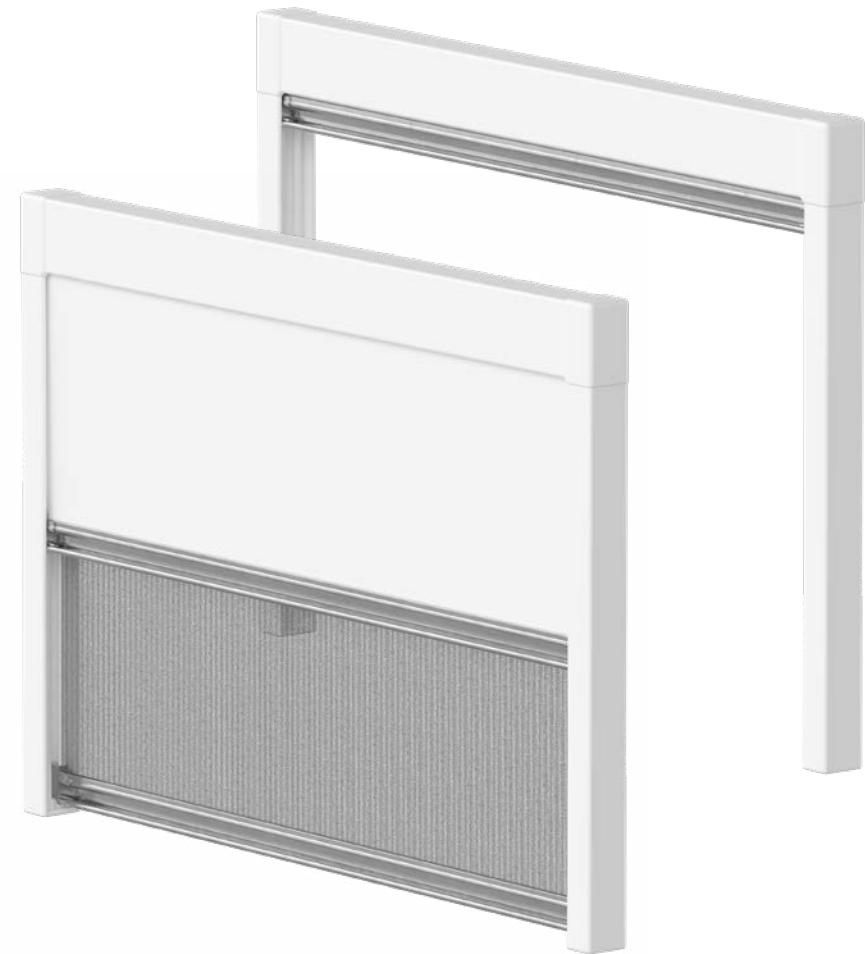

BLINDS & FLYSCREENS

Color options*



Pure white

Oyster white

Jet black

↔ Blind Dimension Ranges		↔ Cutout Dimension Ranges	
↕ H	↕ W	↕ H	↕ W
Available by request only			
385 mm to 1.035 mm	338 mm to 1.888 mm	250 mm to 900 mm	250 mm to 1.800 mm

*Color swatches are representative only. Please call for exact color specifications.



BEDS & LADDERS





Lippert bed frames and lifts are engineered for comfort and adaptability, ensuring that your vehicle is truly a home away from home. We offer tilt and lift options, electric, convertible, extendable, foldable, and much more. Browse our ladders and other accessories to maximize bed functionality.



MODULAR SMART BED

Lifting system | Electric

- Engineered to lift and / or lower in the rear garage, above the dinette, or driver's seat
- High-performing gear motor with optional integrated encoder
- Device fits completely under the bed frame and offers maximum fitting flexibility
- Complete bed lifting system is ready for installation (comes with or without the bed frame)
- Includes manual emergency system
- Heavy-duty steel and aluminum construction
- Available with an advanced control system to manage different positions
- Technical specifications may change depending on customer request
- Available with wall-mounted supports

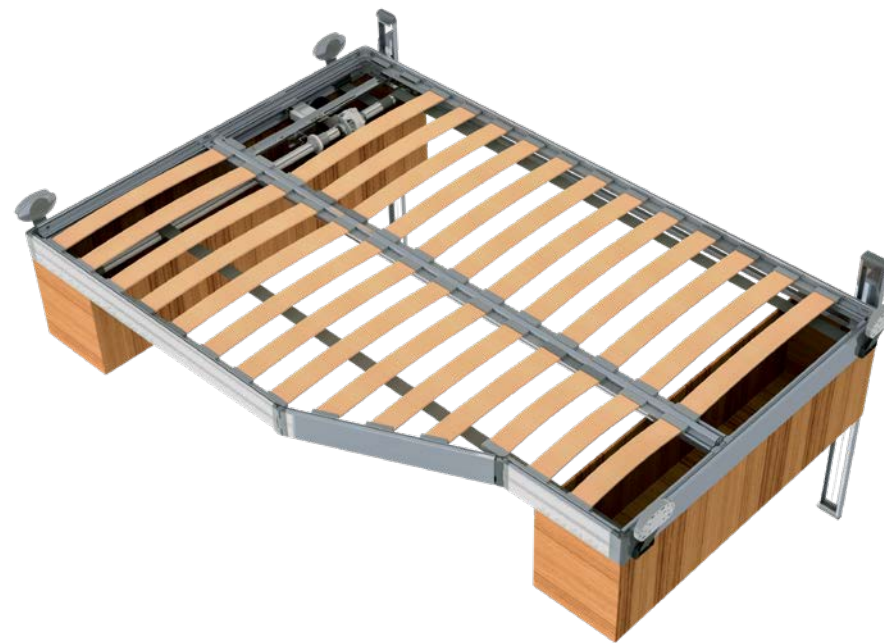

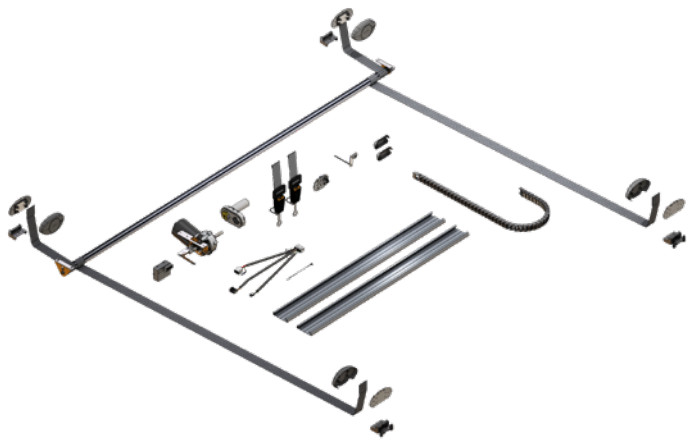

Smart Electric Bed (A)

- Includes all components required: motor unit, stabilization rails, shafts, fixing plates, and 4 m belts
- Adapts to standard measurements up to a maximum of 2.000 × 1.600 mm
- Includes a Lifty handle for manual use



Smart Frame (B)

- Allows you to create a custom bed frame for your unique vehicle space
- Includes standard wooden slats and slat holders that can be cut to size



Smart Accessory (C)

- Attaches the smart bed frame (B) to the bed lifting system (A)
- Provides a customized bed solution for each unique vehicle layout

Part #	Description	Stroke	Operation Speed	Amps	Lift Load	Static Load	🛒*
Smart Electric Bed (A)							
2021104193	Dinette / garage bed lifting kit (single motor)	1.500 mm	~60 mm/sec	12 to 20 A	Up to 60 kg	300 kg	8,6 kg
2021104210	Dinette / garage bed lifting kit (dual motor)	1.500 mm	~60 mm/sec	12 to 20 A	Up to 60 kg	300 kg	8,6 kg
2021104135	Motorhome bed lifting kit	1.500 mm	~60 mm/sec	12 to 20 A	Up to 60 kg	300 kg	8,6 kg
Smart Frame (B)							
2021104120	Slatted bed base	--		--		300 kg	15 kg
Smart Accessory (C)							
2021104124	Attachment brackets	--		--	--	--	--

* Variable according to the requested configuration

DENVER

Lifting bed with extending frame | Electric

- Engineered to lift and / or lower in the rear garage or above the dinette
- High-performing gear motor with optional integrated encoder
- Lifting system fits completely under the bed frame and offers maximum fitting flexibility
- Heavy-duty yet lightweight aluminum frame with wooden slats
- Available with advanced control system to manage different positions
- Includes bed frame and lifting system
- Extendable frame accommodates a larger mattress while ensuring compact storage (extended section must be supported)
- Available with wall fixing



Stroke Range	Static Load	Lift Load	↕ L	↕ W	Operation Speed	Amps	Volts	🛒
Available by request only								
300 to 1.500 mm	300 kg	60 kg	1.900 mm	1.000 to 1.400mm	60 to 100 mm/sec	9 A to 20 A	12V DC	32 kg

DENVER EVO

NEW

Lifting bed with extending frame | Electric

- Engineered to lift and / or lower in the rear garage or above the dinette
- High-performing gear motor with optional integrated encoder
- Lifting system fits completely under the bed frame and offers maximum fitting flexibility
- Heavy-duty yet lightweight aluminum frame with wooden slats
- Available with advanced control system to manage different positions
- Includes bed frame and lifting system
- Extendable frame accommodates a larger mattress while ensuring compact storage (extended section must be supported)
- Available with wall fixing



Stroke Range	Static Load	Lift Load	↕ L	↕ W	Operation Speed	Amps	Volts	🛒
Available by request only								
300 to 1.500 mm	250 kg	60 kg	1.900 mm	1.150 to 1.650mm	60 to 100 mm/sec	2,5 A to 21 A	12V DC	50 kg

BEDS & LADDERS

SEVILLA

Lifting bed with folding frame | Electric

- Engineered to lift and / or lower in the rear garage, above the dinette, or driver's seat
- Hinge for the rotation of a bed portion for installation above the driver
- High-performing gear motor with optional integrated encoder
- Lifting system fits completely under the bed frame and offers maximum fitting flexibility
- Heavy-duty yet lightweight aluminum frame with wooden slats
- Available with advanced control system to manage different positions
- Includes bed frame and lifting system
- Extendable frame accommodates a larger mattress while ensuring compact storage (extended section must be supported)
- Available with wall fixing



Static Load	Lift Load	↕ L	↔ W	Operation Speed	Amps	Volts	🛒
Available by request only							
250 kg	60 kg	1.800 to 1.900 mm	1.350 mm	60 to 100 mm/sec	9 A to 20 A	12V DC	35 kg

LISBONA

Lifting bed | Electric or manual

- Engineered to lift and / or lower in the rear garage
- High-performing gear motor with optional integrated encoder (electric version)
- Available with wall fixing and aluminum legs
- Lifting system fits completely under the bed frame and offers maximum fitting flexibility
- Available with advanced control system to manage different positions (electric version)
- Bed base with hinges and gas springs (optional) to facilitate access to the storage underneath
- Available with electric motor lifting system or manual crank option
- Heavy-duty yet lightweight aluminum frame with wooden slats



Stroke Range	Static Load	Lift Load	↕ L	↔ W	🛒
Available by request only					
300 to 600 mm	250 kg	60 kg	1.900 mm	1.350 mm	46 kg

TOSCANA

Lifting bed | Electric or manual

- Engineered to lift and / or lower in the rear garage, above the dinette, or driver's seat
- High-performing gear motor with optional integrated encoder
- Lifting system fits completely under the bed frame and offers maximum fitting flexibility
- Heavy-duty yet lightweight aluminum frame with wooden slats
- Available with advanced control system to manage different positions
- Includes bed frame and lifting system
- Available with electric motor or manual crank option
- Available with wall fixing, slim profile, and bed frame



Stroke Range	Static Load	Lift Load	↕ L	↕ W	Operation Speed	Amps	Volts	🛒
Available by request only								
300 to 1.500 mm	250 kg	60 kg	2.000 mm	1.300 mm	60 to 100 mm/sec	9 A to 20 A	12V DC	23 kg

DETROIT

Lifting bed | Manual

- Designed for easy installation without wall guides and belts
- Customizable vertical stroke, straight, or swing movement
- Easy installation above the driver
- Heavy-duty yet lightweight aluminum frame with wooden slats
- Lateral steel arms assisted by gas springs for smooth and stable movement
- Lifting and lowering movements can be customized to fit the shape of the vehicle
- Locking system for high bed position
- Onboard frontal handle to lock and unlock the bed positions



Stroke Range	Static Load	Lift Load	↕ L	↕ W	🛒
Available by request only					
300 to 700 mm	250 kg	20 kg	1.950 mm	1.500 mm	36 kg

MANILA

Lifting bed | Manual

- Engineered to lift and / or lower in the rear garage, above the dinette, or driver's seat
- High-performing, zero-gravity gas struts
- Lifting system fits completely under the bed frame and offers maximum fitting flexibility
- Heavy-duty, lightweight aluminum frame with wooden slats
- Fast, easy installation with no wiring required
- Includes bed frame and lifting system
- Available with wall fixing



Stroke	Static Load	Lift Load	↕ L	↕ W	🛒
Available by request only					
950 mm	250 kg	45 kg	1.500 to 1.900mm	1.300 mm	25 kg

MANILA SMART KIT

NEW

Lifting system | Manual

- Engineered to lift and / or lower in the rear garage, above the dinette, or driver's seat
- High-performing, zero-gravity gas struts
- Lifting system fits completely under the bed panel and offers maximum fitting flexibility
- Fast, easy installation with no wiring required
- Includes lifting system
- Available with wall fixing



Stroke	Max Lift Load	↕ L	↕ W	🛒
Available by request only				
950 mm	45 kg	1.900 mm	1.300 mm	25 kg

SAN DIEGO

Lifting bed | Manual

- Designed for easy installation without wall guides and belts
- Customizable vertical stroke, straight, or swing movement
- Easy installation above the driver
- Heavy-duty yet lightweight aluminum frame with wooden slats
- Lateral steel arms assisted by gas springs for smooth and stable movement
- Lifting and lowering movements can be customized to fit the shape of the vehicle
- Locking system for high bed position
- Onboard frontal handle to lock and unlock the bed positions

NEW

FIRENZE

Sliding bed | Electric or manual

- Reclinable back for comfortable sleeping, reading, watching TV, and relaxation
- Sliding design reduces overall dimensions while bed is not in use
- Available in manual, multi-position synchronized-assisted, or electric option
- Heavy-duty yet lightweight aluminum frame with wooden slats
- Available with standard or comfort wooden slats



Stroke Range	Static Load	Lift Load	↕ L	↕ W	🛒
Available by request only					
550 to 870 mm	250 kg	20 kg	1.950 mm	1.500 mm	46,5 kg

Sliding Stroke	Static Load	↕ L	↕ W	🛒
Available by request only				
200 mm	250 kg	1.900 mm	1.350 mm	22 kg

CHICAGO

Extendable folding bed base

- Manually folding, sliding structure
- Heavy-duty yet lightweight aluminum frame with wooden slats
- Gas spring struts assist for easy fold-up into the side wall
- Adjustable feet to promote stability

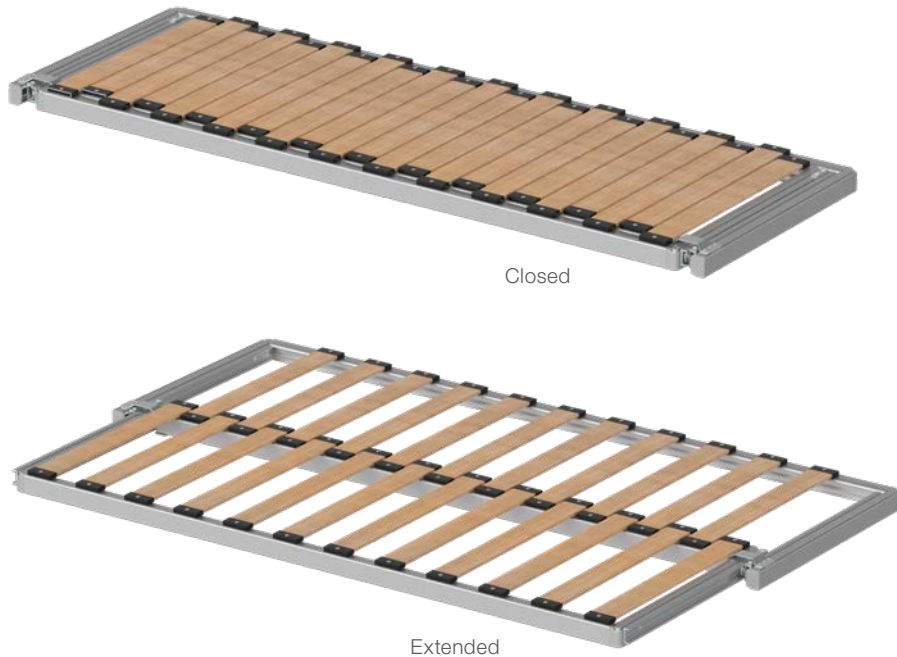

Stroke	Static Load	↕ L	↕ W	🛒
Available by request only				
320 mm	80 kg	1.400 mm	730 to 1.050 mm	18 kg

VIENNA

Folding bed base

- Folding frame to convert from double to single-bed configuration
- Heavy-duty yet lightweight aluminum frame with wooden slats



Static Load	↕ L	↕ W	🛒
Available by request only			
100 kg	1.900 mm	650 to 1.300 mm	13 kg

OSLO & OSLO PLUS

Extending bed base

- Extendable frame to convert from single to double-bed configuration
- Larger frame profile on Oslo Plus
- Heavy-duty yet lightweight aluminum frame with wooden slats



Oslo closed



Oslo Plus closed

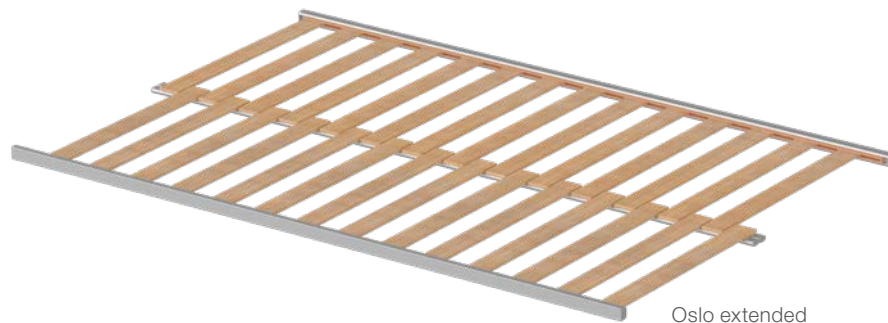

Oslo extended

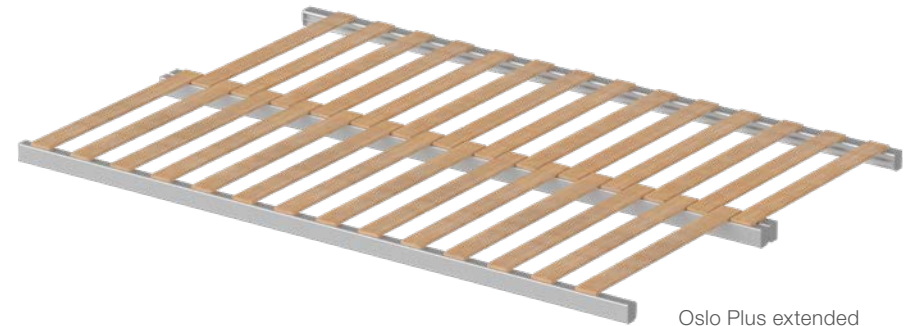

Oslo Plus extended

Static Load	↕ L	↔ W	↕ H	🛒
Oslo - Available by request only				
200 kg	1.950 mm	730 to 1.300 mm	35 mm	11 kg

Static Load	↕ L	↔ W	↕ H	🛒
Oslo Plus - Available by request only				
200 kg	1.950 mm	730 to 1.300 mm	50 mm	15 kg

BARCELONA

Sliding bed base

- Manually sliding slats ensure easy access to storage area underneath
- Heavy-duty yet lightweight aluminum frame with wooden slats



Static Load	↕ L	↕ W	🛒
Available by request only			
120 kg	1.700 mm	600 mm	3 kg

LONDRA

Roll-up bed base

- Flexible PVC side rails roll up for compact storage
- Wood slats for strength, comfort, and a stylish accent
- Available in single or double-bed configurations
- Includes side rail assemblies and slats

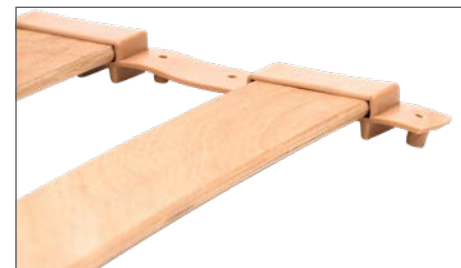

Wood slats for strength, comfort, and a stylish accent



Flexible PVC side rails roll up for compact storage

Style	Static Load	↕ L	↕ W	🛒
Available by request only				
Single base	120 kg	1.900 mm	650 mm	5 kg
Double base	200 kg	1.900 mm	1.300 mm	14 kg

MADRID

Bed base

- Bed base with rear hinges and gas springs to facilitate access to the storage underneath
- Designed for motorhomes, caravans, and tent trailers
- Heavy-duty yet lightweight aluminum frame with wooden slats
- Includes bed frame and gas springs



Static Load	↕ L	↕ W	🛒
Available by request only			
200 kg	1.900 mm	1.320 mm	19 kg

MONACO

NEW

Bed base

- Slim, lightweight aluminum frame with wooden slats
- Space-saving slim profile is 10 mm lower and 22% lighter than a standard profile
- Interchangeable components with the Nice bed base
- Available in single or double-bed configuration

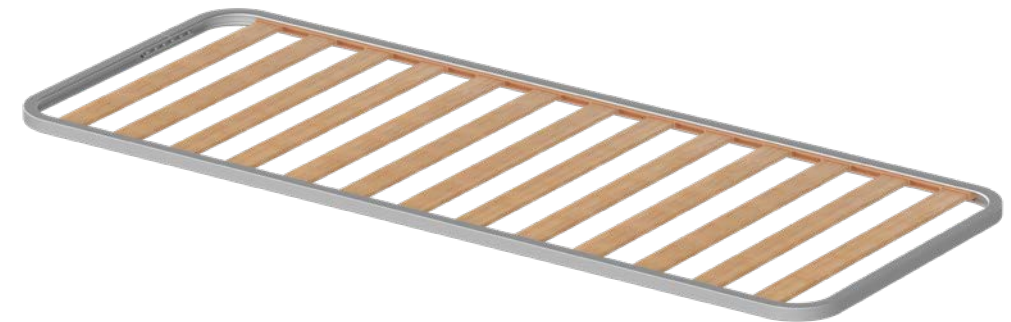

Static Load	↕ L	↕ W	🛒
Available by request only			
100 kg	1.900 mm	650 mm	6 kg

NICE

Bed base

- Heavy-duty yet lightweight aluminum frame with wooden slats
- Available in single or double-bed configurations



Static Load	↕ L	↔ W	🛒
Available by request only			
100 kg	1.900 mm	650 mm	7 kg

SANTA CRUZ

NEW

Bed base

- Heavy-duty yet lightweight anodized aluminum frame
- Fire-resistant net for strength, comfort, and a stylish accent
- Compatible with virtually all types of vehicles
- Foldable legs allow for use as beach lounger

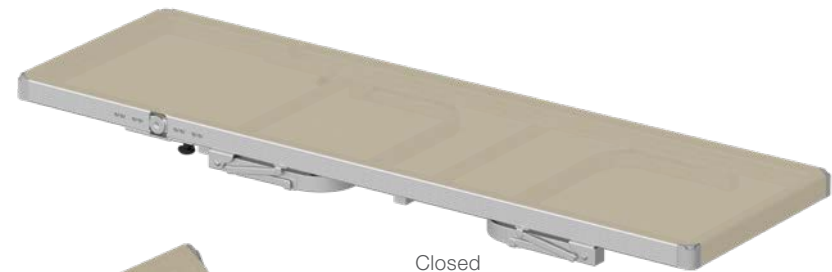

Closed



Open

Static Load	↕ L	↔ W	🛒
Available by request only			
100 kg	1.900 mm	650 mm	11 kg

MAYDA

Bed base

- Heavy-duty yet lightweight aluminum frame with wooden slats
- Profile can be trimmed to customize bed shape and dimensions
- Bed assembly required

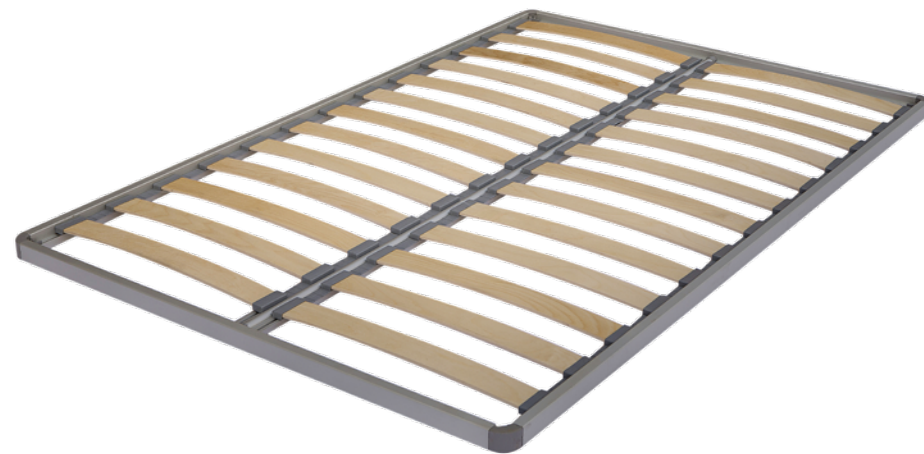

Part #	Static Load	↕ L	↕ W	🛒
2021104143	200 kg	2.000 mm	1.300 mm	15 kg

SARA

Bed base

- Heavy-duty yet lightweight aluminum frame with wooden slats
- Profile can be trimmed to customize bed shape and dimensions
- Bed assembly required



Part #	Static Load	↕ L	↕ W	🛒
2021104194	100 kg	2.000 mm	900 mm	8 kg

VAN BED

Folding bed base

- Fold-up frame provides comfortable sleeping arrangements and allows for compact storage
- Heavy-duty yet lightweight aluminum frame with wooden slats

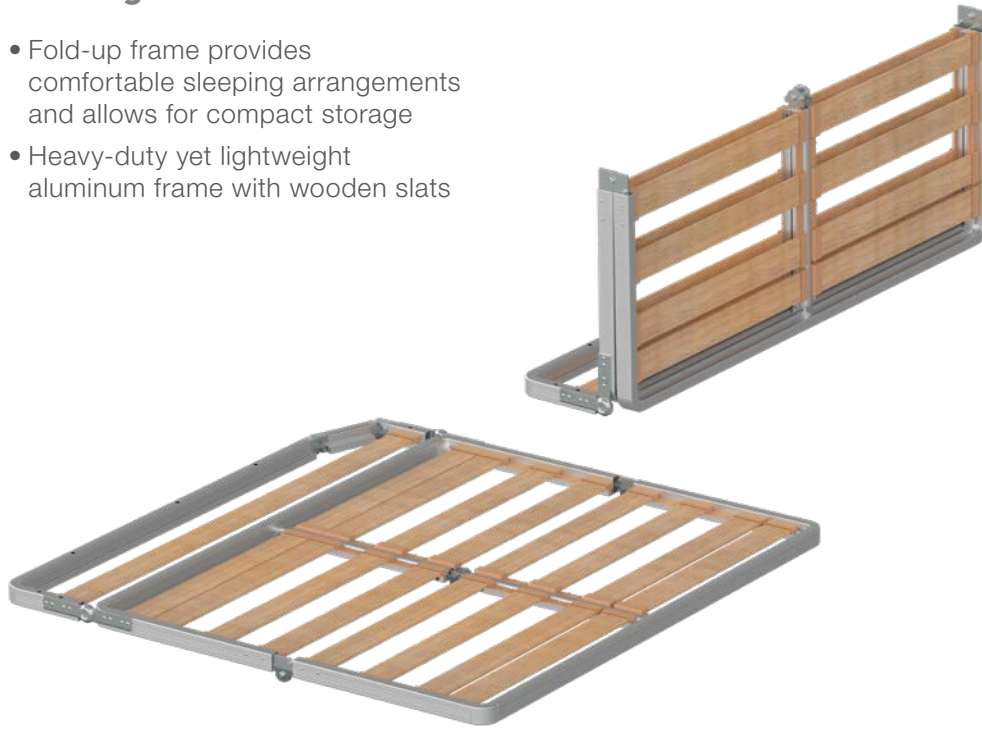

Perfectly fits the dimensions of the campervan (mattress not included)



Fold-up frame for comfortable sleeping arrangements with compact storage

Part #	Static Load	↕ L	↕ W	🛒
2021104154	100 kg	1.500 mm	1.500 mm	19 kg



BEDS & LADDERS

PRODUCT WEIGHT DIMENSION ↕

LIFTER

Control panel

- Switch with a control panel to manage the bed lifting movement
- Can be integrated into the bed frame on specific bed profiles
- Available with or without key



2021104289
(with key)



202346265
(without key)



2022112411
(with key)



Lifter switch control panels can be integrated into the bed frame

Part #	Name	Includes Key	Color
2021104289	Lifter 1	Yes	Grey
2020346265	Lifter 2	No	Grey
2022112411	Lifter 3	Yes	Black

ELEKTRA SMART

Control panel

- Control box with control panel to manage the bed lifting movement (Elektra 1 & 2)
- Switch with a control panel to manage the bed lifting movement (Elektra 3)
- Can be installed separately from the bed frame
- Available with or without key

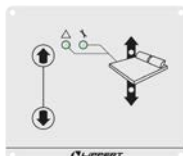

2021104249
(without key)

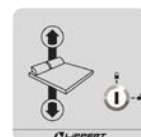

2022013464
(with key)

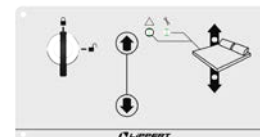

2021104299
(with key)

Part #	Name	Includes Key	Color
2021104249	Elektra Smart 1	No	Grey
2022013464	Elektra Smart 2	Yes	Grey
2021104299	Elektra Smart 3	Yes	Grey

BELT

Lifting belt

- Durable nylon straps are available in black, grey, and cream
- Compatible with all Lippert beds



Part #	↕ L	↕ W	Color
2020334518	4.000 mm	46,5 mm	Black
2020343787	4.000 mm	46,5 mm	Grey
2021104281	4.200 mm	46,5 mm	Cream
2021104300	6.000 mm	46,5 mm	Grey
2020343375	7.000 mm	46,5 mm	Black

LIFTING CAPACITY

Lifting belt rollers

- Belt roller system to help belts move more easily when raising or lowering the bed
- Includes four rollers for a basic system
- Purchase two kits for a return system that will allow double the lifting capacity
- Compatible with all Lippert beds



Part #	Lift Load Without Return	Lift Load With Return
2021104276	60 kg	120 kg

DISKY

Lifting belt spacers

- Plastic spacers keep lifting belts in place and aligned for smooth operation



Part #	Compatibility
2021104277	For use with Belt products

SAFETY STRAP

Lifting belt safety straps

- Promotes safety while bed is lifted
- Compatible with all Lippert beds



Part #	Compatibility
2020334746	For use with Belt products

CABLE TRACK

Lifting track

- Comes in two lengths
- Available in black or beige
- Compatible with all Lippert beds



Part #	Chain Links	↕ L	Color
2020335126	50	1.000 mm	Black
2020344588	105	2.250 mm	Beige

ENDY

End caps

- Provides a finished look on standard guides
- Durable plastic construction
- Hardware not included



Part #	Compatibility
2020339437	Fits standard guides

STANDARD GUIDE

Bed channel

- Standard aluminum guide for lifting beds
- Compatible with all Lippert beds



Part #	↕ L
2020334767	990 mm

ENDY C

End caps

- Provides a finished look on C-shaped guides
- Strong steel construction
- Hardware not included



Part #	Compatibility
2022116096	Fits C-shaped guides

C-SHAPED GUIDE

Bed channel

- C-shaped aluminum guide for lifting beds
- Compatible with all Lippert beds



Part #	↕ L
2021104251	1.600 mm



STICKLY

Bed slats and slat holders

- Slats constructed from birchwood
- Available in multiple sizes



2020341629
Stickly Cap Right



2020341630
Stickly Cap Left



2021104285
Stickly 68



2021104306
Stickly Cap



2021104303
Stickly Cap Open

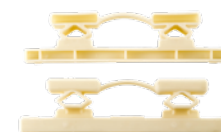

2021104231
Stickly Cap Comfort

Part #	Name	Description	↕ L	↕ W	↕ H
2021104302	STICKLY 52	Wooden slat	1.000 mm	52 mm	8 mm
2021104230	STICKLY 62	Wooden slat	1.000 mm	62 mm	8 mm
2021104278	STICKLY 62	Wooden slat	1.400 mm	62 mm	8 mm
2021104285	STICKLY 68	Wooden slat	890 mm	68 mm	8 mm
2020341629	STICKLY CAP RIGHT	Slat holder	438 mm	26 mm	8 mm
2020341630	STICKLY CAP LEFT	Slat holder	438 mm	26 mm	8 mm
2021104306	STICKLY CAP	Slat holder	--	52 mm	8 mm
2021104253	STICKLY CAP	Slat holder	--	62 mm	8 mm
2021104297	STICKLY CAP	Slat holder	--	68 mm	8 mm
2021104303	STICKLY CAP OPEN	Slat holder	--	--	8 mm
2021104231	STICKLY CAP COMFORT	Slat holder	--	--	8 mm

SMARTY

Leg

- Fold-out leg to accommodate a rectangular mattress
- Lightweight anodized aluminum frame

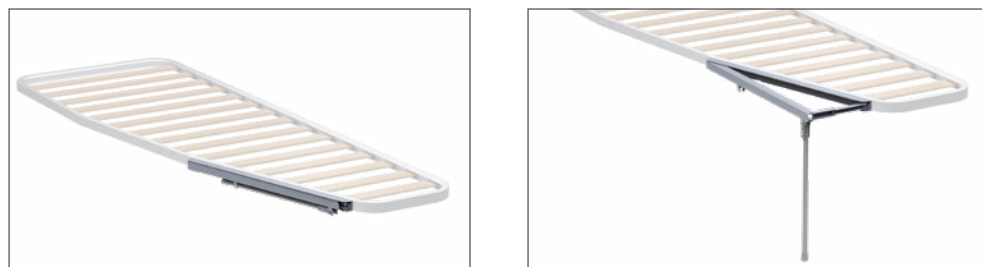

Lightweight fold-out leg attaches to bed base to provide a platform support for a rectangular mattress

Static Load	Extended Angle	↑ H
Available by request only		
100 kg	17°	696 mm

BACKREST

Bed accessory

- Manual operation
- Completely autonomous and integrable with the bed frame
- Available by request only

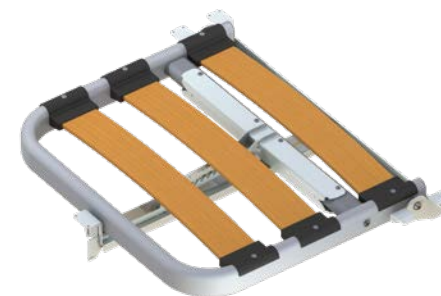

LIFTY

Handle

- Allows manual movement of the bed



Part #	Description
2020334839	Lifty Handle



VOLO

Safety net

- Attaches to the bedside to prevent nighttime falling
- For children over six years old
- Lightweight yet durable aluminum rail construction
- Double-coated PVC and 100% polyester mesh for a dependable net
- Compatible with virtually all lifting beds



Double-coated PVC and 100% polyester mesh for a dependable net



Comes with all required installation hardware and straps

Part #	↕ L	↕ H	📦	🏠
2021104280	1.500 mm	576 mm	Aluminum	Nylon / PVC
2021104274	1.800 mm	580 mm	Aluminum	Nylon / PVC

MOLLA

NEW

Suspension for slats

- Plastic springs easily install on wooden bed slats to provide mattress support and ventilation
- Lightweight, compact design for easy and quick installation with no tools required
- Adjustable clamps secure to existing bed slats
- Adjustable spring height from 35 to 55 mm with two included spacers
- Molla for Panels cross-shaped plastic support required for installation on bed panels (sold separately)
- Includes 12 springs, 12 clamps, and 24 spacers (48 springs are required for a single bed)

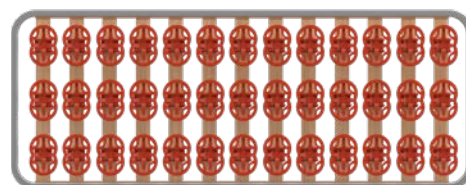
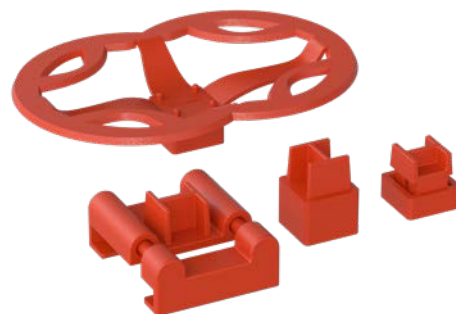

Plastic springs easily install on wooden bed slats to provide mattress support and ventilation



Adjustable clamps secure to existing bed slats

Part #		H	L	W	
2024030923	Plastic	35 to 55 mm	152,8 mm	102,8 mm	70 to 110 gr

MOLLA

NEW

Suspension for panels

- Designed to support Molla spring suspensions
- Modular and adaptable cross-shaped bases easily adjust to accommodate different bed frames
- Screws securely onto a wooden surface for sturdy installation
- Works seamlessly with the provided spacers in the Molla suspension kit
- Perfect for various applications requiring adjustable support
- 12 modular bases

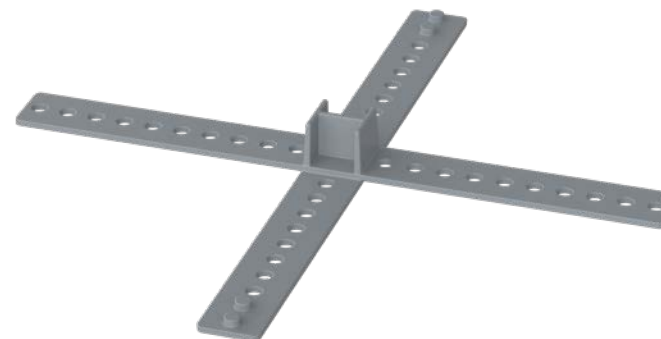

Part #		H	L	W	
2024030924	Plastic	19 mm	224 mm	224 mm	30 to 70 gr



STLA FLEX

Suspension

- Suspends bed frame to improve sleep comfort
- Durable plastic construction with memory shape for maximum comfort
- Can be mounted on all beds with staves
- 36 pieces required for single bed and 72 for double bed



2023022746



2023022767

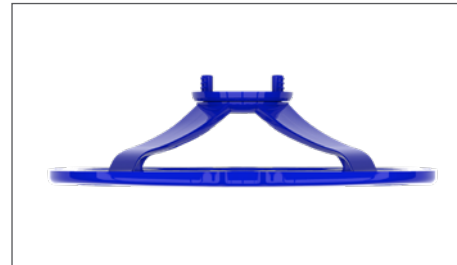

Suspends bed frame to improve sleep comfort



Can be mounted on all beds with staves

Part #	Name	Description	📦	↕ H	↕ L	↕ W
2023022746	StLa FLEX base	Bed susp. with base pins	Plastic	40 mm	46 mm	46 mm
2023022767	StLa FLEX base	Bed susp. with base hole	Plastic	40 mm	46 mm	46 mm

TITTA

Bunk ladder

- Aluminum bunk ladder with hooks
- T-Feet 15 maximize friction to avoid slipping and ensure stability
- T-Hook 6 provides a safe, robust connection to the bed frame
- Durable and lightweight aluminum construction
- Includes T-Hook Base hook supports



Rounded rungs for comfortable grip and footing



Feet maximize friction to avoid slipping and ensure stability

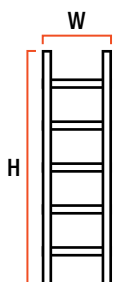

TITTA LARGE-STEP

Bunk ladder

- Rounded rungs for comfortable climbing
- T-Feet 15 maximize friction to avoid slipping and ensure stability
- T-Hook 6 provides a safe, robust connection to the bed frame
- Durable and lightweight aluminum construction
- Includes T-Hook Base hook supports



Extra-wide, step-like rungs for maximum comfort



Hooks provide a safe, robust connection to the bed frame

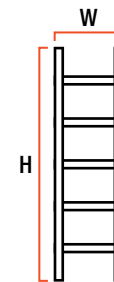

Part #	↕ H	↔ W	📦	📦
2021104315	1.300 mm	290 mm	1,60 kg	100 kg
2021104247	1.500 mm	290 mm	1,74 kg	100 kg
2021104260	1.700 mm	290 mm	2,00 kg	100 kg

Part #	↕ H	↔ W	📦	📦
2021104267	1.300 mm	290 mm	1,97 kg	100 kg
2021104240	1.500 mm	290 mm	2,37 kg	100 kg
2021104242	1.700 mm	290 mm	2,75 kg	100 kg

TITTA FOLDING 2

Bunk ladder

- Folding mechanism with heavy-duty hinges for compact storage
- T-Feet 15 maximize friction to avoid slipping and ensure stability
- T-Hook 6 provides a safe, robust connection to the bed frame
- Durable and lightweight aluminum construction
- Includes T-Hook Base hook supports



Closed



Extended



Rounded rungs for comfortable grip and footing

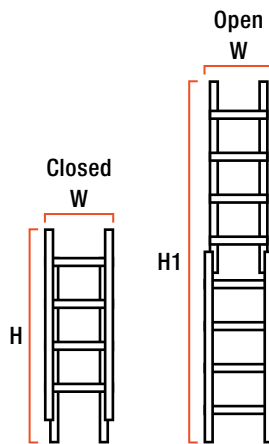

Part #	↕ H	↕ H1	↕ W	📦	📦
2021104312	870 mm	1.450 mm	290 mm	2,30 kg	100 kg
2021104294	990 mm	1.700 mm	290 mm	3 kg	100 kg



LADDER CONNECTION

Accessory | Ladder

- Handle with safety hooks for secure ladder attachment and easier climbing
- Recommended for bed frames that are not suitable for connecting ladder hooks
- Durable and lightweight aluminum construction
- Designed for use with T-Hook 4 only

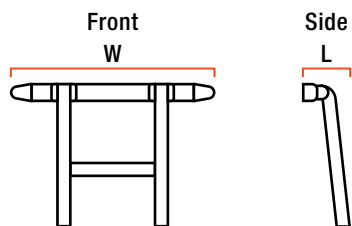

Part #	↕ L	↕ W	📦
2021104257	60 mm	700 mm	0,30 kg

HOOKS

Replacement | Ladder

- Provides a safe, robust ladder connection to the bed frame
- Durable and lightweight plastic construction
- Includes one component per package



Part #	Name	Compatible With
2021104259	T-Hook 1	Titta, Titta Folding 2, Titta Large-Step
2022110420	T-Hook 2	Titta Strong and Titta Strong Folding (left side)
2021104263	T-Hook 2	Titta Strong and Titta Strong Folding (right side)
2021104236	T-Hook 3	Titta, Titta Folding 2, Titta Large-Step
2021104220	T-Hook 4	Titta, Titta Folding 2, Titta Large-Step
2021104226	T-Hook 5	Titta, Titta Folding 2, Titta Large-Step
2021104217	T-Hook 6	Titta, Titta Folding 2, Titta Large-Step
2022128709	S-Hook	Safety hook for all T-Hooks
2021104223	T-Hook Base	T-Hook 2, T-Hook 4, T-Hook 6

FEET

Replacement | Ladder

- Maximizes friction to avoid slipping and ensure ladder stability
- Flexible and lightweight plastic construction
- Includes one component per package

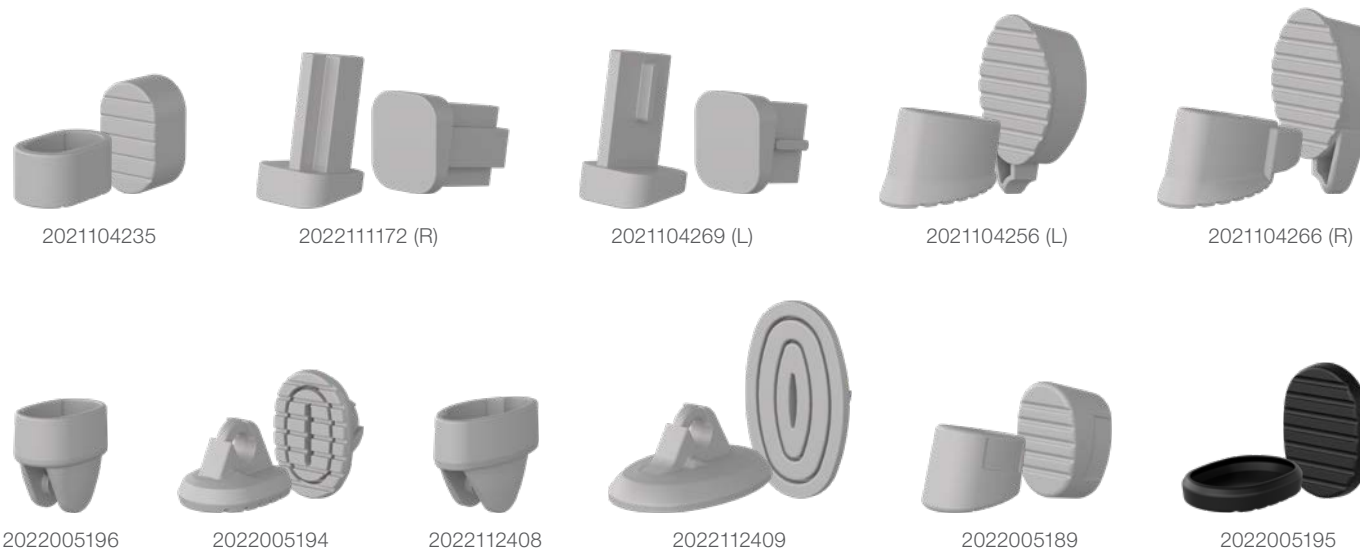

Part #	Name	Description
2021104235	T-Feet	Flat foot for Titta, Titta Folding 2, Titta Large-Step
2021104269	T-Feet Soft HS	Left soft foot for Titta, Titta Folding 2, Titta Large-Step
2022111172	T-Feet Soft HR	Right soft foot for Titta, Titta Folding 2, Titta Large-Step
2021104256	T-Feet HS	Left foot for Titta Strong
2021104266	T-Feet HR	Right foot for Titta Strong
2022005196	Up T-Feet	Upper part adjustable foot for Titta, Titta Folding 2, Titta Large-Step
2022005194	Down T-Feet Way	Lower part adjustable foot for Titta, Titta Folding 2, Titta Large-Step
2022112408	Up T-Feet Way Strong	Upper part adjustable foot for Titta Strong and Titta Strong Folding
2022112409	Down T-Feet Way Strong	Lower part adjustable foot for Titta Strong and Titta Strong Folding
2022005189	T-Feet 15	Adds 15° angle foot for Titta, Titta Folding 2, Titta Large-Step
2022005195	T-Feet Way Pad	Anti-slip pad for T-Feet Way



TV BRACKETS





Lippert offers a wide selection of TV brackets and mounts to provide the perfect solution for each van, campervan, or motorcaravan. Our TV mounts are available in a range of sizes, material options, and configurations, including powered models, to ensure a custom fit for any interior.

BUMBLEBEE

Wall mounting system | Manual

- Three self-braking joints for easy viewing
- Available in single, double, or triple rotation axis
- Modular design is sleek and lightweight
- Steel and aluminum construction with a matte black powder coat finish

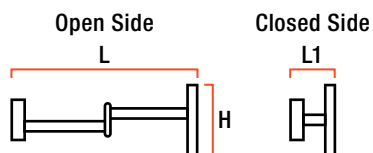

Part #	↵ L	↵ L1	↗ H	📦	📦	⊠
2024036426	Up to 560 mm	38 mm (vertical)	120 mm	Up to 0.9 kg	8 kg	75 x 75 mm 100 x 100 mm
2024036427	Up to 558 mm	58 mm (vertical, horizontal)	120 mm	Up to 1,5 kg	8 kg	
2024036428	Up to 562 mm	62mm (vertical, horizontal, perpendicular)	120 mm	Up to 1,7 kg	8 kg	

NEW

BUTTERFLY

Wall mounting system | Manual

Butterfly 2

- Pantograph mechanism maximizes extension while maintaining a low profile
- Support arm can be locked in place while vehicle is in motion
- Revolves and tilts 180° up or down for easy visibility anywhere in the van
- Steel construction

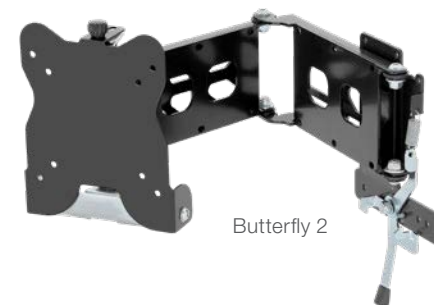

Butterfly 3

- Three-joint swivel arm for easy viewing
- 110mm height adjustment range for custom positioning
- Tilts 180° up or down for easy viewing
- Automatically locks in closed position for safe travel
- Support arm can be locked in place while vehicle is in motion
- Steel construction

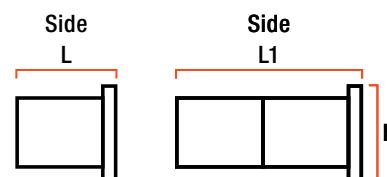

Part #	Butterfly	↵ L	↵ L1	↗ H	📦	📦	⊠
2021104201	2	34 mm	229 mm	156 mm	1,2 kg	8 kg	75 x 75 mm
2021104176	2	45 mm	403 mm	156 mm	1,5 kg	8 kg	100 x 100 mm
2021104204	2	45 mm	443 mm	156 mm	1,7 kg	8 kg	
2021104165	3	84 mm	482 mm	160 mm	2,4 kg	8 kg	



DAISY 2

Wall mounting system | Manual

- Rotates from 120° to 130° and tilts up to 23° for easy viewing
- Support arm can be locked in place while vehicle is in motion
- Steel construction



Rotates from 120° to 130° and tilts up to 23° for easy viewing

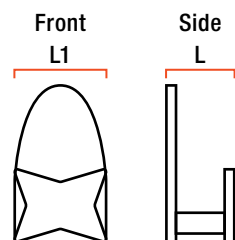

Part #	↻ L	↻ L1	↻ H	📦	📦	⊠
2021104172	78 mm	120 mm	120 mm	8,0 kg	10 kg	75 x 75 mm / 100 x 100 mm

LOTUS

Wall mounting system | Manual

Lotus 1

- Three self-braking joints with 15° tilt for easy viewing and adjustment
- Ability to close in either direction to better adapt to van layout
- Support arm can be locked in place while vehicle is in motion
- Aluminum and steel construction

Lotus 2

- Three self-braking joints with adjustable 0° to 15° tilt for easy viewing
- Support arm can be locked in place while vehicle is in motion
- Steel construction



Lotus 1



Lotus 2

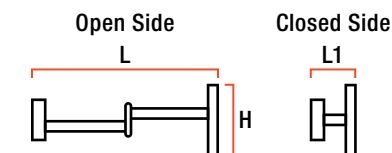

Part #	Lotus	↻ L	↻ L1	↻ H	📦	📦	⊠
2021104171	1	529 mm	63 mm	120 mm	1,2 kg	8 kg	75 x 75 mm
2021104134	2	424 mm	82 mm	120 mm	1,3 kg	10 kg	100 x 100 mm
2021104150	2	570 mm	82 mm	120 mm	1,5 kg	10 kg	

SNAPDRAGON

Wall mounting system | Manual

- 90° rotation for vertical TV storage
- Two-joint swivel arm for easy viewing
- Lockable rotation and in closed position for safe travel

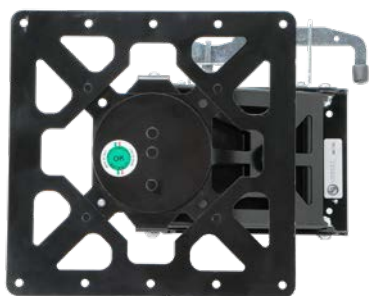

Closed front

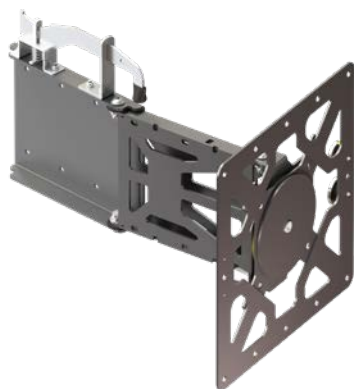

Open



Two-joint swivel arm for easy viewing

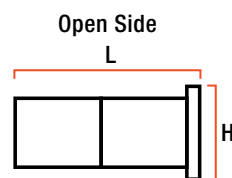

Part #	— L	∩	↗ H	🛒	🛒	✂
2021104159	190 mm	37 mm	220 mm	2,1 kg	10 kg	200 x 100 mm / 200 x 200 mm



SUNFLOWER

Wall mounting system | Manual

Sunflower 1

- Rotates 180° and features a three-joint swivel arm for easy viewing
- Height adjustment range with lever brake
- Designed to mount on the right or left side
- Aluminum and steel construction
- Profile with narrow guide

Sunflower 2

- Rotates 180° and features a three-joint swivel arm for easy viewing
- Features adjustable 0° to 15° tilt
- Height adjustment range with lever brake
- Designed to mount on the right or left side
- Sleek and lightweight anodized aluminum arm
- Extruded aluminum profile



Sunflower 1

Sunflower 2

Sunflower 3

- Rotates 180° and features a three-joint swivel arm for easy viewing
- Height adjustment range with lever brake
- Designed to mount on the right or left side
- Extruded aluminum profile

Sunflower 4

- Rotates 180° and features a three-joint swivel arm for easy viewing
- Height adjustment range with lever brake
- Top end-cap provides a finished look
- Designed to mount on the right or left side
- Extruded aluminum profile



Sunflower 3

Sunflower 4

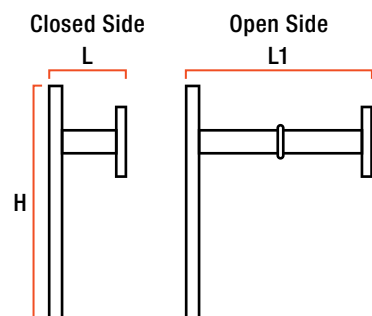

Part #	Sunflower	↕ H	↙ L	↔ L1	🛒	📦	⊠
2021104168	1	850 mm	62 mm	444 mm	1,9 kg	8 kg	75 x 75 mm
2021104152	2	600 mm	86 mm	554 mm	1,6 kg	8 kg	100 x 100 mm

Part #	Sunflower	↕ H	↙ L	↔ L1	🛒	📦	⊠
2021104202	3	990 mm	58 mm	250 mm	1,7 kg	8 kg	75 x 75 mm
2021104180	4	990 mm	99 mm	440 mm	1,8 kg	8 kg	100 x 100 mm

TULIP

Wall mounting system | Manual

Tulip 1

- Pantograph mechanism maximizes extension while maintaining low profile
- Magnetic security blockage keeps bracket locked while closed
- Revolves for easier visibility anywhere in the van



Tulip 1

Tulip 2

- Compatible with Lavender TV brackets
- 90° rotation for vertical TV storage
- Two-joint swivel arm for easy viewing
- Lockable rotation and closed position for safe travel
- Horizontal sliding movement
- Support arm can be locked in place while vehicle is in motion
- Steel construction



Tulip 2

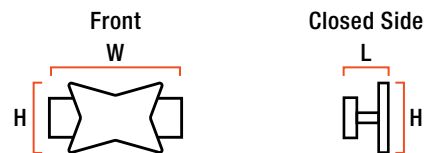

→ L	↻ H	🛒	🛒	✕
Available by request only				
278 mm	120 mm	0,8 kg	10 kg	75 x 75 mm 100 x 100 mm



EDELWEISS 2

Lifting system | Manual

- Three-joint swivel arm with 180° swivel for easy viewing
- Lift mechanism can be locked in place while vehicle is in motion

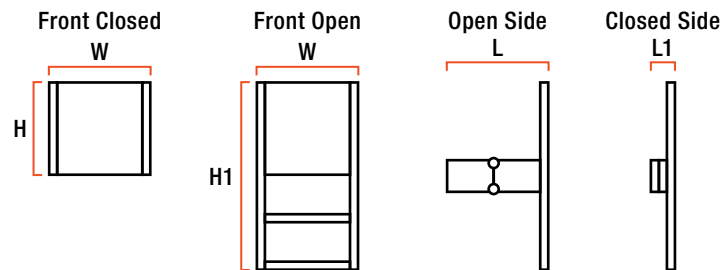

— L	∨ L1	∨ H	— H1	↕ W	🛒	📦	✕
Available by request only							
280 mm	131 mm	440 mm	891 mm	480 mm	7,3 kg	8 kg	75 x 75 mm 100 x 100 mm 200 x 100 mm

LAVENDER

Lifting system | Manual

- Two-joint swivel arm for easy viewing
- 400 mm height adjustment range and 10° to 170° pivot for custom positioning
- Right or left placement to adapt to any van layout



Open front



Two-joint swivel arm for easy viewing

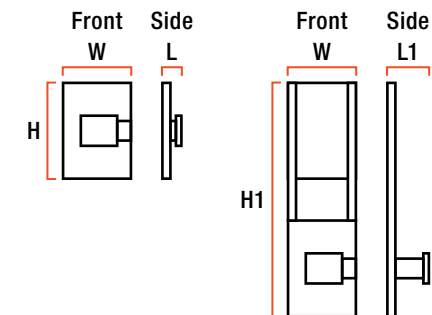

↕ W	∨ H	— H1	L	L1	🛒	📦	✕
Available by request only							
194 mm	310 mm	700 mm	47 mm	152 mm	2,9 kg	8 kg	75 x 75 mm 100 x 100 mm

LILY

Lifting system | Electric

- Motorized lift allows the TV to be completely hidden when retracted
- Designed to drop down from a cabinet
- Extends up to 80 mm and tilts up to 23° for easy viewing
- Right or left placement to adapt to any van layout
- Multifunctional electronic control unit requires 3 A of energy input

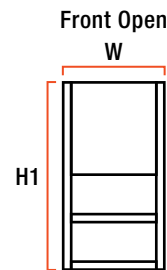
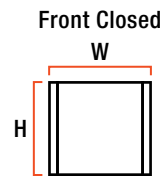
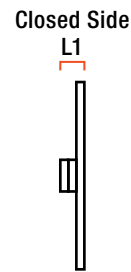
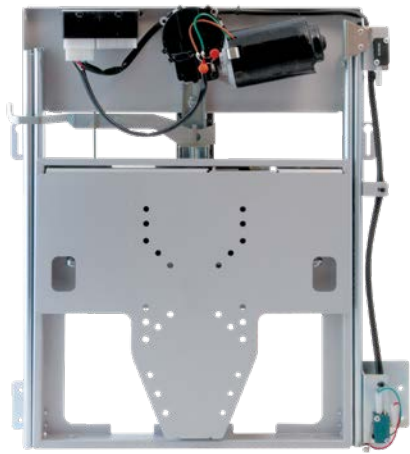

Motorized lift allows to TV to be completely hidden when retracted

→ L	↘ L1	↘ H	→ H1	↻ W	🛒	🛒	✕
Available by request only							
124,1 mm	104,4 mm	467 mm	880 mm	356 mm	7,4 kg	10 kg	75 x 75 mm 100 x 100 mm

VIOLET 2

Lifting system | Electric

- Motorized lift allows TV to be completely hidden when retracted
- Dual-motor, belt-driven mechanism for smooth, even sliding
- Tilt adjustment for easy viewing
- Incoming voltage: 13V
- Maximum amperage: 6 A

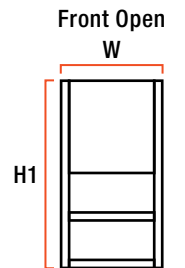
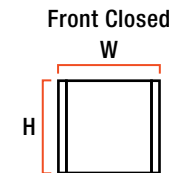
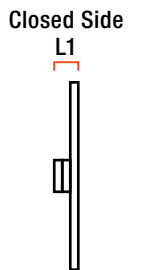
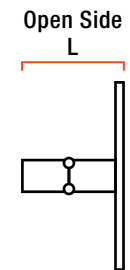
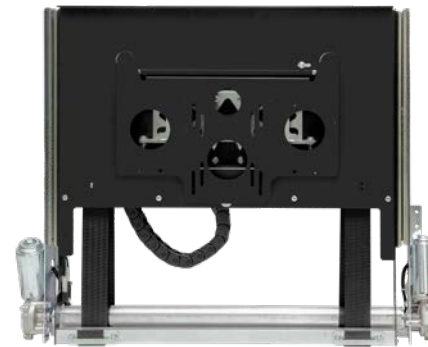

Motorized lift allows to TV to be completely hidden when retracted

→ L	↘ L1	↘ H	→ H1	↻ W	🛒	🛒	✕
Available by request only							
133,8 mm	95 mm	504 mm to 532 mm	950 mm to 958 mm	398 mm to 635 mm	7,1 to 9,5 kg	8 to 15 kg	75 x 75 mm 100 x 100 mm 200 x 100 mm

DRAGONFLY

Pole mounting system | Manual

- Rotates 270° and features a three-joint swivel arm for easy viewing
- Adjustable height on the pole with locking knobs for custom positioning
- Mounting pole not included

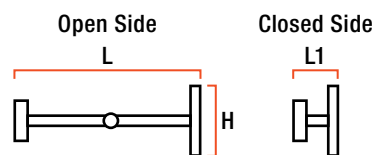

Part #	→ L	↙ L1	↗ H	🛒	🛒	✕
2021104123	475 mm	131 mm	200 mm	1,6 kg	8 kg	75 x 75 mm / 100 x 100 mm

IRIS

Ceiling mounting system | Manual

- Revolves 360° and tilts for easy viewing
- Vertical adjustment with 129 mm of range
- Horizontal adjustment
- Steel construction

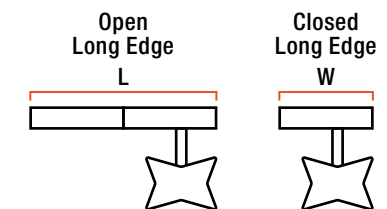

Vertical adjustment with 129 mm stroke for custom positioning

→ L	↙ W	🛒	🛒	✕
Available by request only				
802 mm	360 mm	2,9 kg	8 kg	75 x 75 mm / 100 x 100 mm

PRIMULA

Ceiling mounting system | Manual

- Revolves and tilts for easy viewing
- Automatically locks in closed position for safe travel
- Pivoting support locks at various intervals for custom positioning
- Low-profile design when closed for compact storage



Low-profile design when closed for compact storage

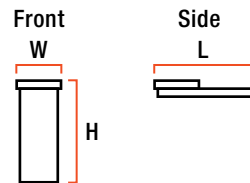

W	L	H			
Available by request only					
150 mm	275 mm	52 mm	1,4 kg	8 kg	75 x 75 mm / 100 x 100 mm

WILLOW

Ceiling mounting system | Manual

- Adds three-joint swivel arm to Wisteria sliding TV brackets
- Low-profile design when closed for compact storage
- Can be mounted to the wall, ceiling, or counter top

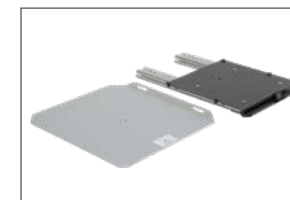

Wisteria



Willow



Wisteria and Willow assembled

Wall Mounted Side - Closed



Wall Mounted Side - Open

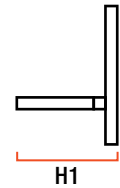

Ceiling Mounted Side - Closed

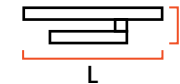

Ceiling Mounted Side - Open

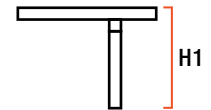

Counter Mounted Side - Closed

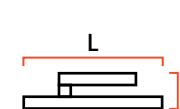

Counter Mounted Side - Open

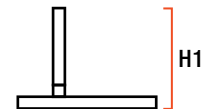

L	H	H1			
Available by request only					
324 mm	81 mm	504 mm	2,0 kg	8 kg	75 x 75 mm / 100 x 100 mm



TABLE LEGS





Whether it's enjoying a meal together, playing a game or mapping out the next destination, the table is the centerpiece of a caravan or campervan. Lippert table legs are highly versatile and available in a wide array of configurations, providing the perfect, integrated fit.

COLUMN

Table leg | Fixed

- Plastic and aluminum slide components
- Steel construction for maximum strength
- Available with sliding and rotating table support

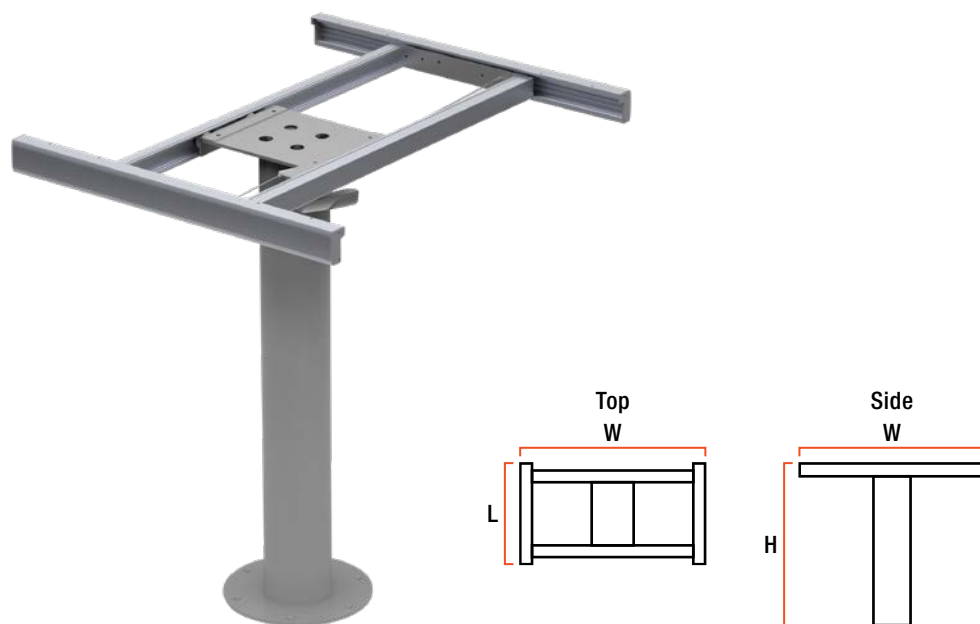

Part #	Slide Directions	Rotates	↕ H	↔ W	↔ L	↔ Foot Size
2021104526	4	No	720 mm	695 mm	560 mm	220 x 220 mm

CORNER

Table leg | Fixed

- Rotating base plate
- Steel construction for maximum strength
- Round tube profile

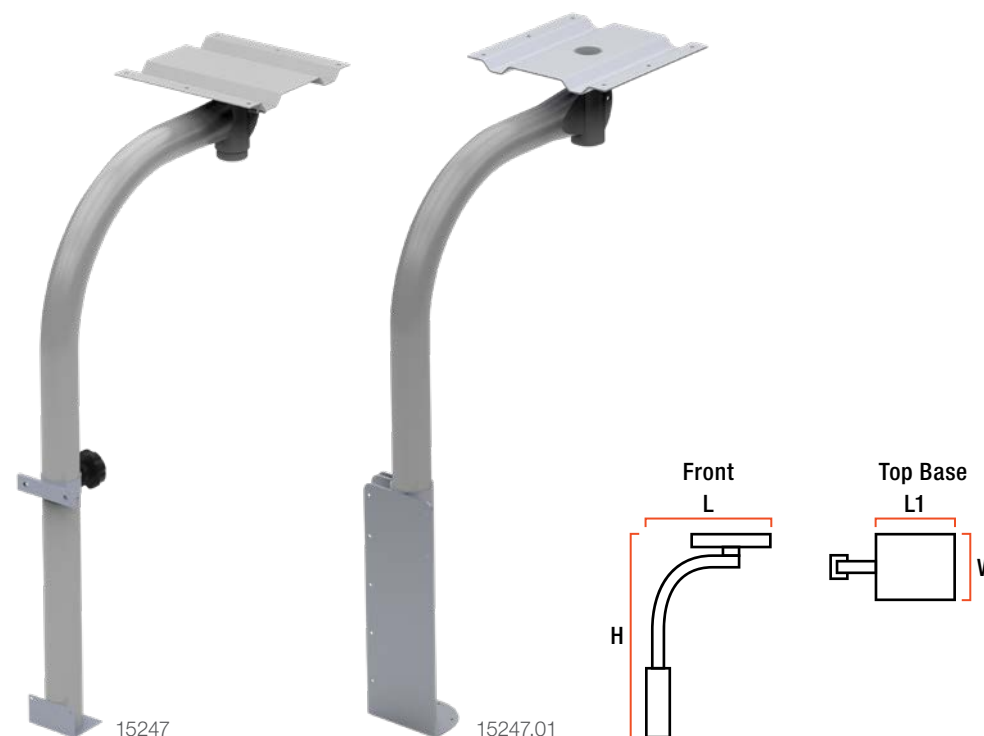

Part #	Version	Rotates	↕ H	↔ L	↔ L1	↔ W	↔ Foot Size
2021104541	Corner 1	Yes	735 mm	450 mm	200 mm	200 mm	70 x 54 mm
2021104537	Corner 2	Yes	730 mm	450 mm	200 mm	200 mm	100 x 80 mm

TABLE LEGS

RAINBOW

Table leg | Fixed

- Arched wood support
- Available with sliding and rotating table support

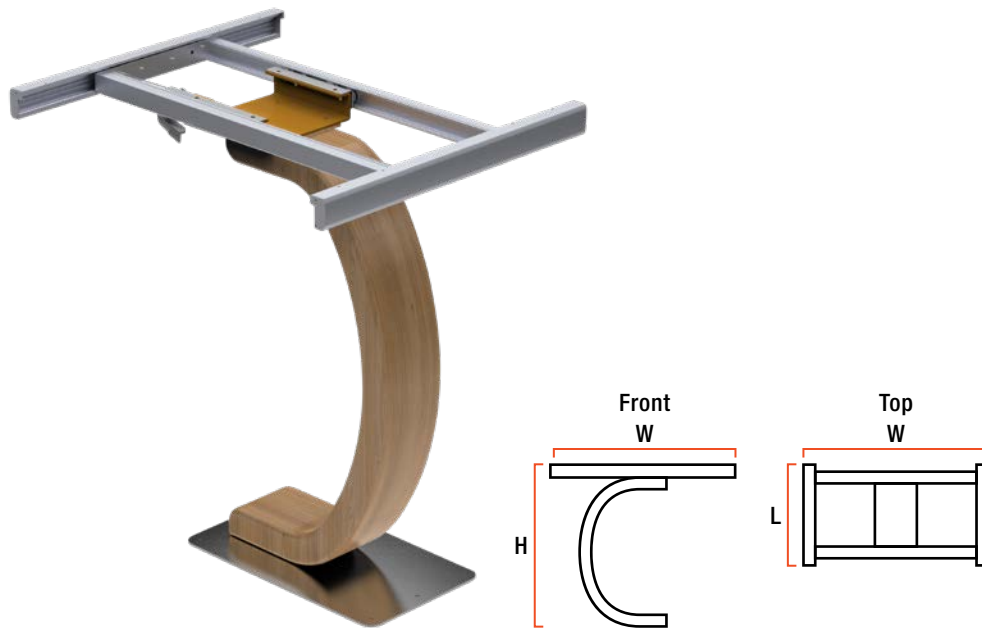

Part #	Slide Directions	Rotates	↕ H	↔ W	↔ L	↕ Leg Width	↔ Foot Size
2021104522	4	No	760 mm	695 mm	560 mm	128 mm	300 x 250 mm
2021104564	4	Yes	760 mm	695 mm	560 mm	128 mm	300 x 250 mm
2021104566	Leg only	No	--	--	--	128 mm	--

UNIVERSO

Table leg | Fixed

- Plastic and aluminum slide components
- Steel construction for maximum strength
- Available with sliding and rotating table support

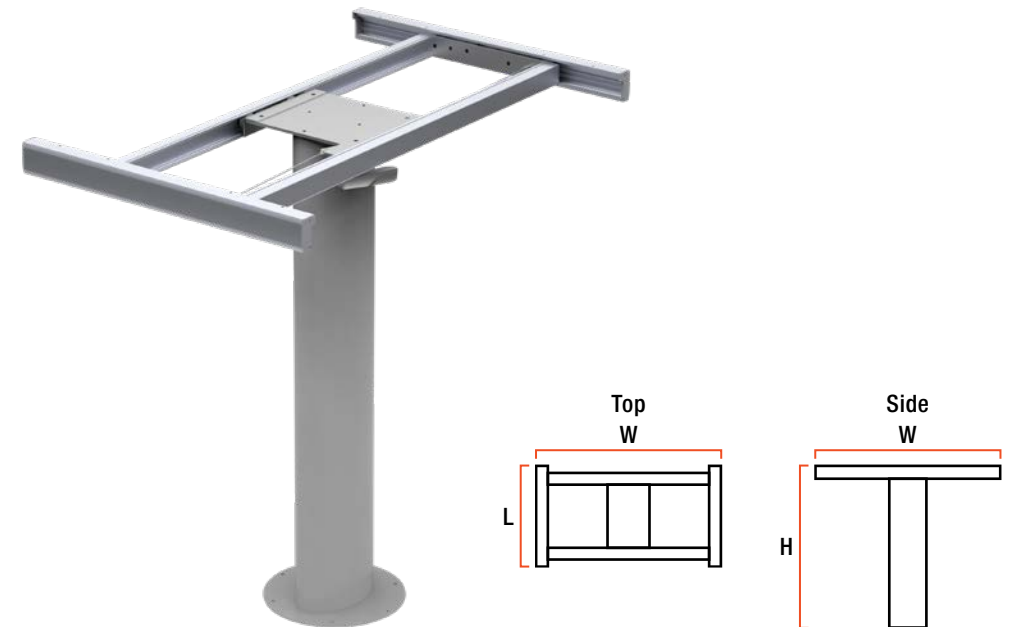

Part #	Slide Directions	Rotates	↕ H	↔ W	↔ L	↔ Foot Size
2021104679	4	No	740 mm	680 mm	560 mm	220 x 220 mm

COSMO

Table leg | Telescoping

- Plastic and aluminum slide components
- Steel construction for maximum strength
- Available with sliding and rotating table support

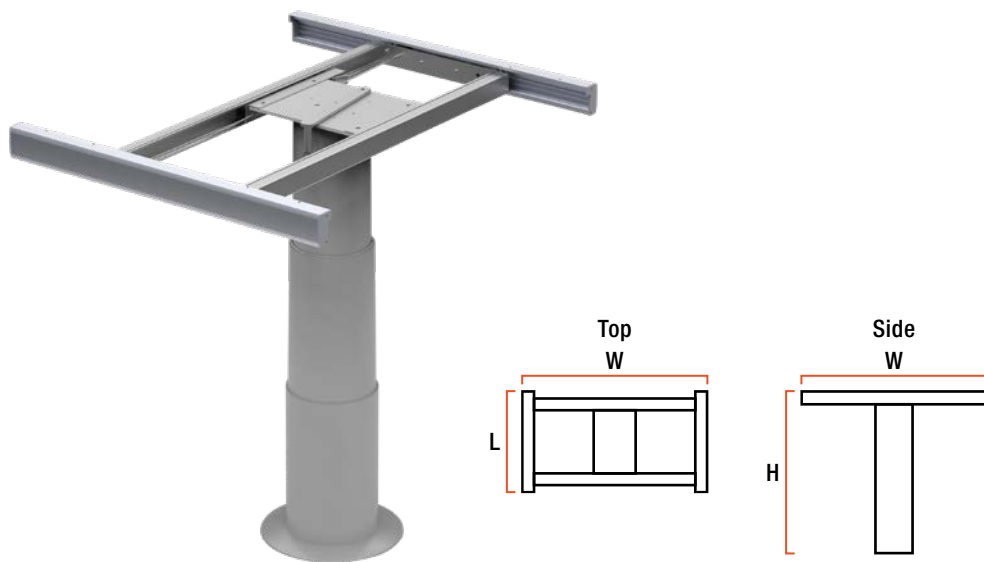

Part #	Slide Directions	Rotates	↔ H	↗ W	↘ L	↗ Foot Size
2021104558	4	No	340 to 720 mm	695 mm	560 mm	220 x 220 mm
2021104554	4	Yes	340 to 720 mm	695 mm	560 mm	220 x 220 mm

GALAXY

Table leg | Telescoping

- Telescoping leg with automatic uplift for easy height adjustment
- Steel construction for maximum strength
- Available with sliding and rotating table support

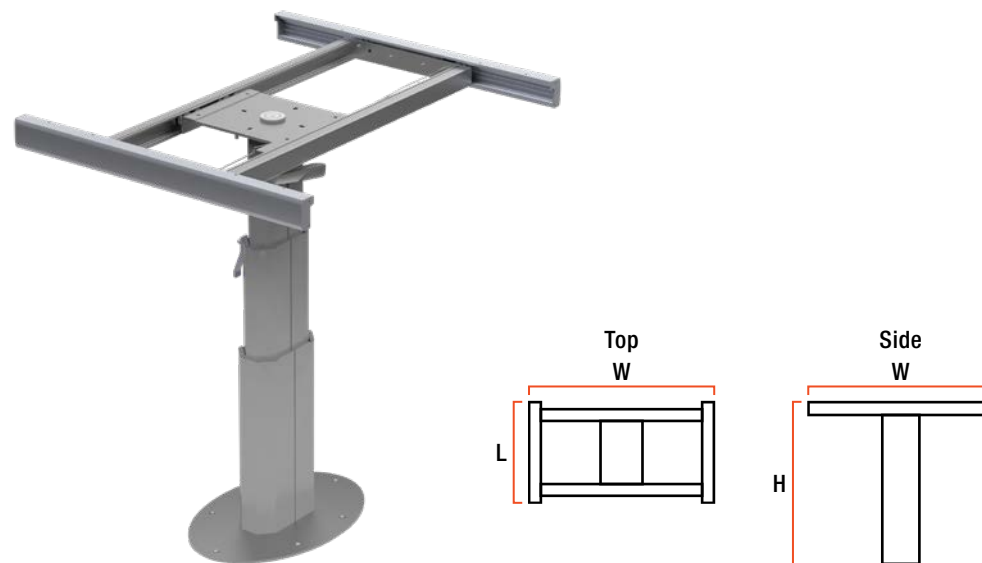

Part #	Slide Directions	Rotates	↔ H	↗ W	↘ L	↗ Foot Size
2021104562	4	No	340 to 730 mm	695 mm	560 mm	340 x 240 mm
2021104521	4	Yes	340 to 730 mm	695 mm	560 mm	340 x 240 mm

MISTRAL

Table leg | Telescoping

- Leg detaches from base for additional breakdown
- Plastic and aluminum components to be strong and lightweight
- Round tube profile

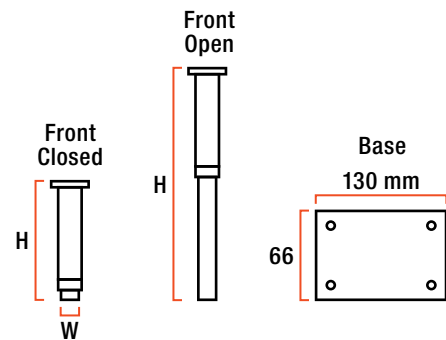

Part #	Foot Style	↔ H	↕ W	↕ Foot Size
2022008229	Simple	312 mm to 710 mm	45 mm	45 mm x 45 mm



ASTRO

Table leg | Folding

Astro 1

- Folding design for compact storage
- Extruded, anodized aluminum to be strong and lightweight
- Rectangular tube profile for a sturdy, functional accent
- Tough plastic hinge and top plate will never rust

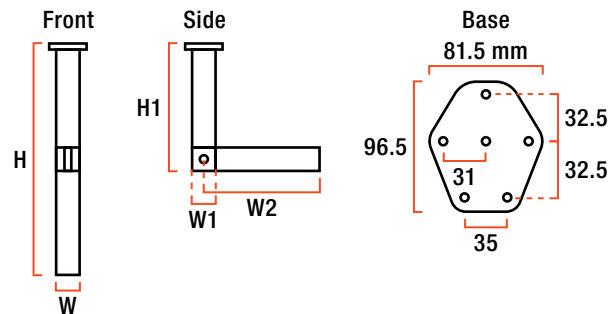

Part #	Foot	↕ H	↕ H1	↕ W	↕ W1	↕ W2	↕ Foot Size
2021104613	Simple	720 mm	380 mm	40 mm	32 mm	335 mm	49 x 41 mm

Astro 2

- Folding design for compact storage
- Telescoping option available
- Extruded, anodized aluminum to be strong and lightweight
- Rectangular tube profile
- Plastic hinge and top plate
- Bottom foot for increased stability
- Customizable hinge position

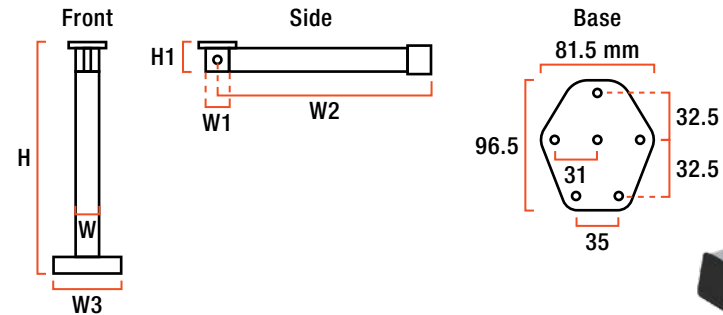
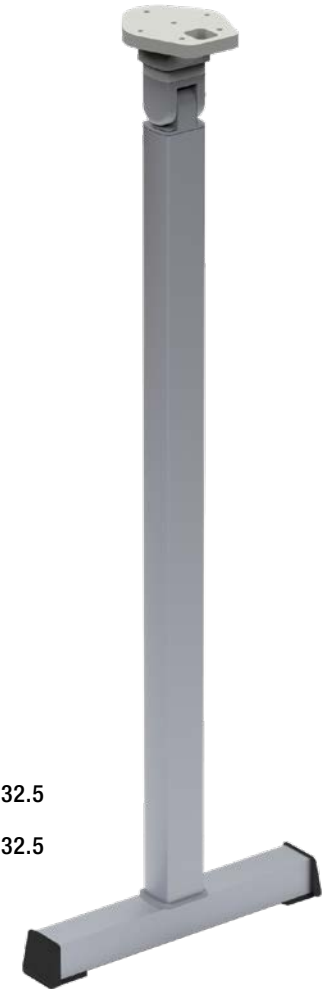

Part #	Foot	↕ H	↕ H1	↕ W	↕ W1	↕ W2	↕ W3	↕ Foot Size
2021104603	Simple	720 mm	75 mm	40 mm	32 mm	660 mm	235 mm	235 x 41 mm
2021104545	Wheeled	720 mm	75 mm	40 mm	32 mm	660 mm	235 mm	235 x 41 mm
2021104615	Telescoping	720 mm	75 mm	40 mm	32 mm	660 mm	235 mm	235 x 41 mm

Astro 3

- Folding design for compact storage
- Telescoping option available
- Extruded, anodized aluminum to be strong and lightweight
- Rectangular tube profile
- Plastic hinge and top plate
- Customizable hinge position

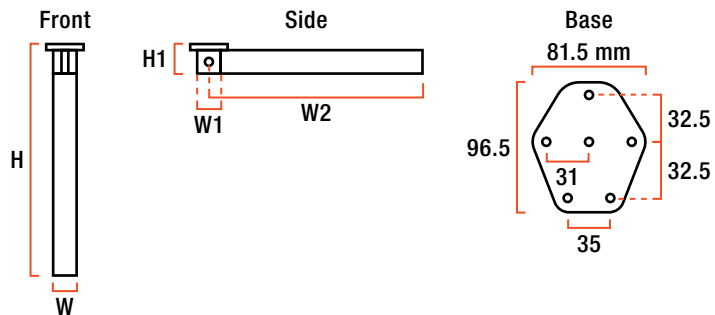

Part #	Foot	↕ H	↕ H1	↕ W	↕ W1	↕ W2	↕ Foot Size
2021104532	Simple foot	720 mm	75 mm	40 mm	32 mm	660 mm	49 x 41 mm
2021104593	Wheeled	720 mm	75 mm	40 mm	32 mm	660 mm	49 x 41 mm
2021104614	Telescoping	720 mm	75 mm	40 mm	32 mm	660 mm	49 x 41 mm



TABLE LEGS

COMET

Table leg | Folding

Comet 1

- Folding design for compact storage
- Extruded, anodized aluminum to be strong and lightweight
- Oval tube profile
- Plastic hinge and top plate
- Hinge on the top of the plate

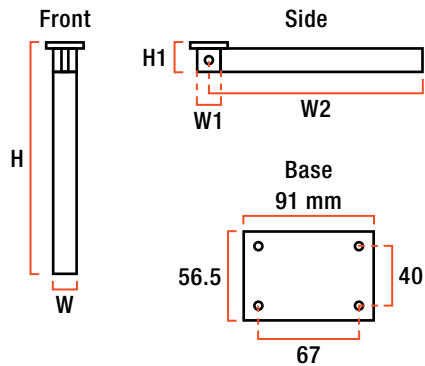
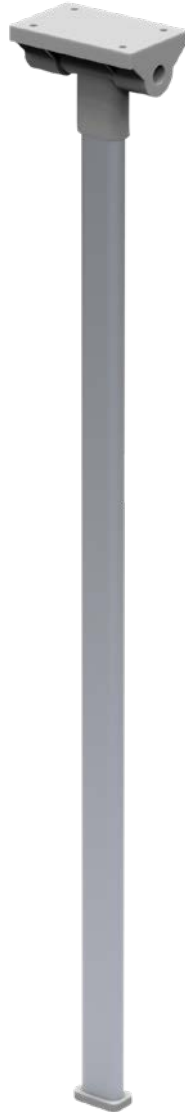

Comet 2

- Top-fold design for compact storage
- Extruded, anodized aluminum to be strong and lightweight
- Oval tube profile
- Plastic hinge and top plate
- Hinge on the top of the plate
- Dual-leg configuration with bottom foot for enhanced stability

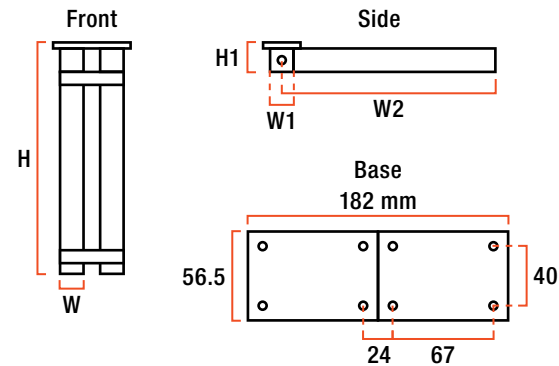
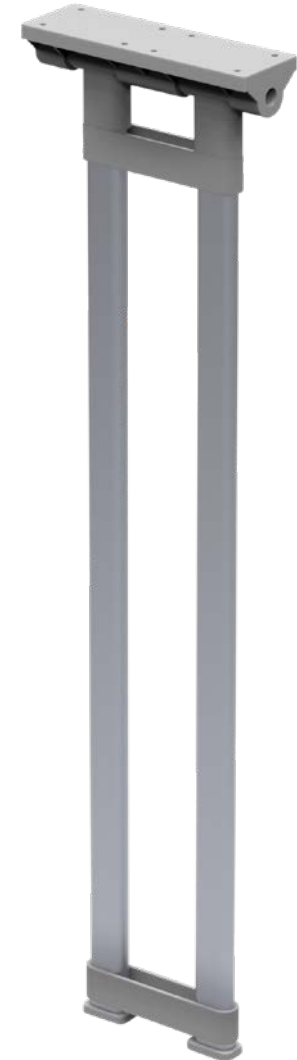

Part #	Foot	↕ H	↕ H1	↕ W	↕ W1	↕ W2	↕ Foot Size
2021104523	Simple	720 mm	37 mm	30 mm	15 mm	700 mm	50 x 32 mm

Part #	Foot	↕ H	↕ H1	↕ W	↕ W1	↕ W2	↕ Foot Size
2021104616	Simple	720 mm	37 mm	30 mm	15 mm	700 mm	139 x 32 mm

Comet 3

- Folding design for compact storage
- Extruded, anodized aluminum to be strong and lightweight
- Oval tube profile
- Plastic hinge and top plate
- Hinge on the top of the plate
- Leg is not pre-cut
- Assembly required

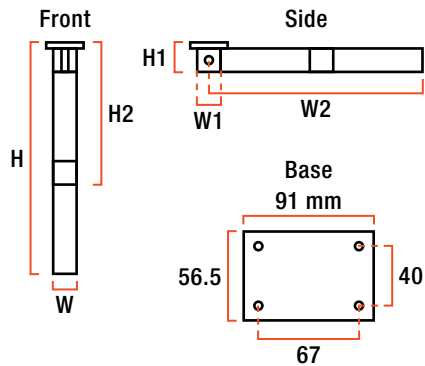

Comet 4

- Folding design for compact storage
- Leg detaches from base for additional breakdown
- Extruded, anodized aluminum to be strong and lightweight
- Oval tube profile
- Plastic hinge and top plate
- Hinge on the top of the plate

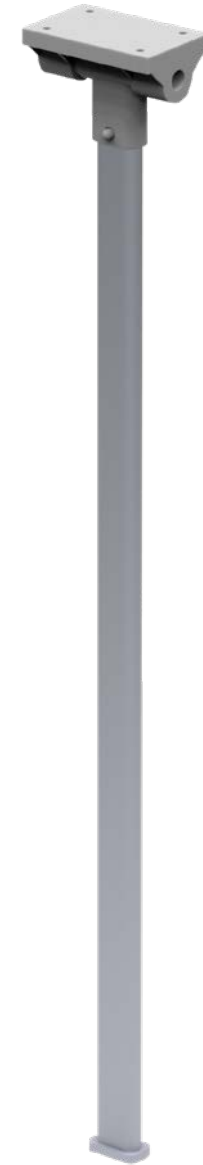
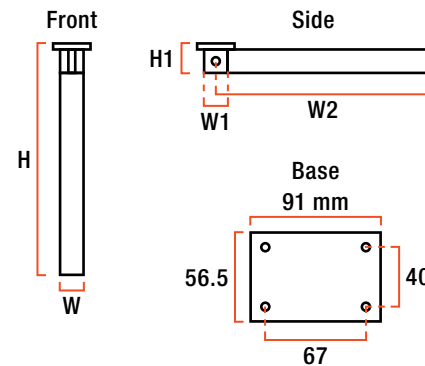

Part #	Foot	↕ H	↕ H1	↕ H2	↕ W	↕ W1	↕ W2	↕ Foot Size
2021104533	Simple	720 mm	37 mm	409 mm	30 mm	15 mm	700 mm	50 x 32 mm

Part #	Foot	↕ H	↕ H1	↕ W	↕ W1	↕ W2	↕ Foot Size
2021104594	Simple	720 mm	37 mm	30 mm	15 mm	700 mm	50 x 32 mm

FOLDNSTRETCH

Table leg | Folding

- Folding design for compact storage
- Extruded, anodized aluminum to be strong and lightweight
- Die-cast aluminum hinge and galvanized steel top plate
- Allows table to slide out as needed to fully optimize interior space
- Rectangular tube profile
- Table top not included

NEW



Position 1 - Leg folded inside



Position 2 - Leg out



Position 3 - Leg out, top extended

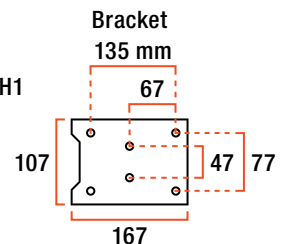
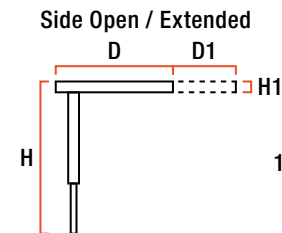

Part #	Foot	↕ H	↕ H1	↕ D	↕ D1	↕ W	↕ Foot Size
2024030903	Simple	550 to 930 mm	35 mm	587 mm	Up to 390 mm	157 mm	65 x 35 mm

TABLE LEGS



TABLE LEGS

MAGNUM

Table leg | Folding

Magnum 1

- Folding design for compact storage
- Extruded, anodized aluminum to be strong and lightweight
- Fluted oval tube profile
- Die-cast aluminum hinge and top plate
- Customizable hinge position

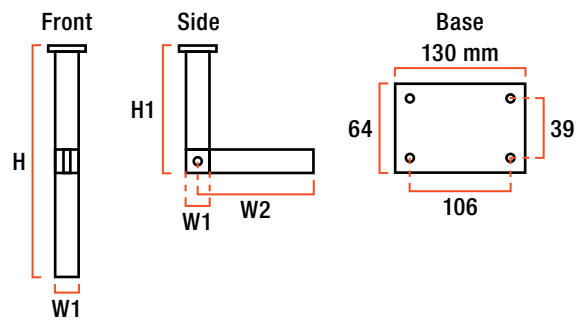

Part #	Foot	↕ H	↕ H1	↕ W	↕ W1	↕ W2	↕ Foot Size
2021104538	Simple	720 mm	380 mm	70 mm	33 mm	375 mm	75 x 38 mm

Magnum 2

- Folding design for compact storage
- Extruded, anodized aluminum to be strong and lightweight
- 70 x 30 mm fluted oval tube profile for a robust accent
- Die-cast aluminum hinge and top plate will never rust

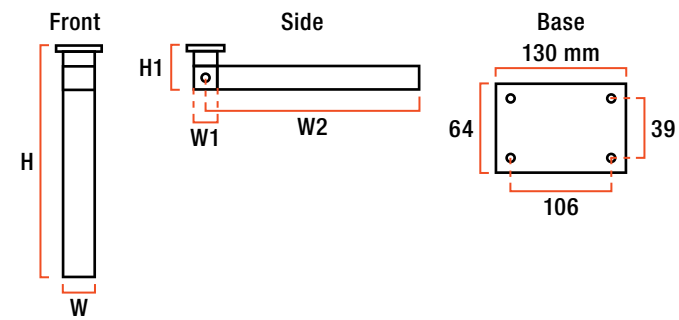
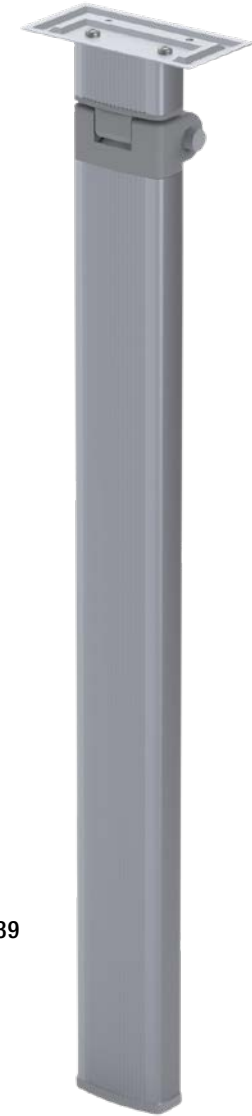

Part #	Foot	↕ H	↕ H1	↕ W	↕ W1	↕ W2	↕ Foot Size
2021104612	Simple	720 mm	100 mm	70 mm	33 mm	655 mm	75 x 38 mm

STABILIOUS & STABILIOUS EVO

Table leg | Folding

Magnum 3

- Folding design for compact storage
- Extruded, anodized aluminum to be strong and lightweight
- Fluted oval tube profile
- Die-cast aluminum hinge and top plate
- Bottom foot for increased stability
- Customizable hinge position

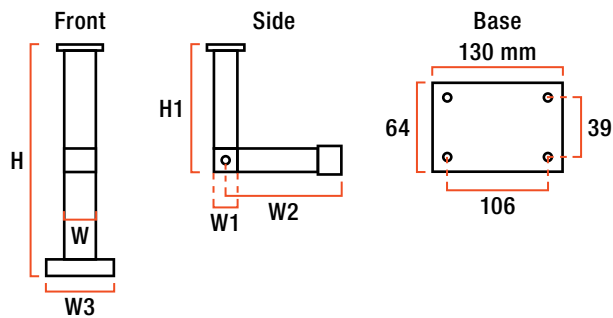

- Wide-stance design to support large tables
- Folding base for compact storage
- Painted steel construction for maximum strength
- Includes one pair of legs (table top not included)

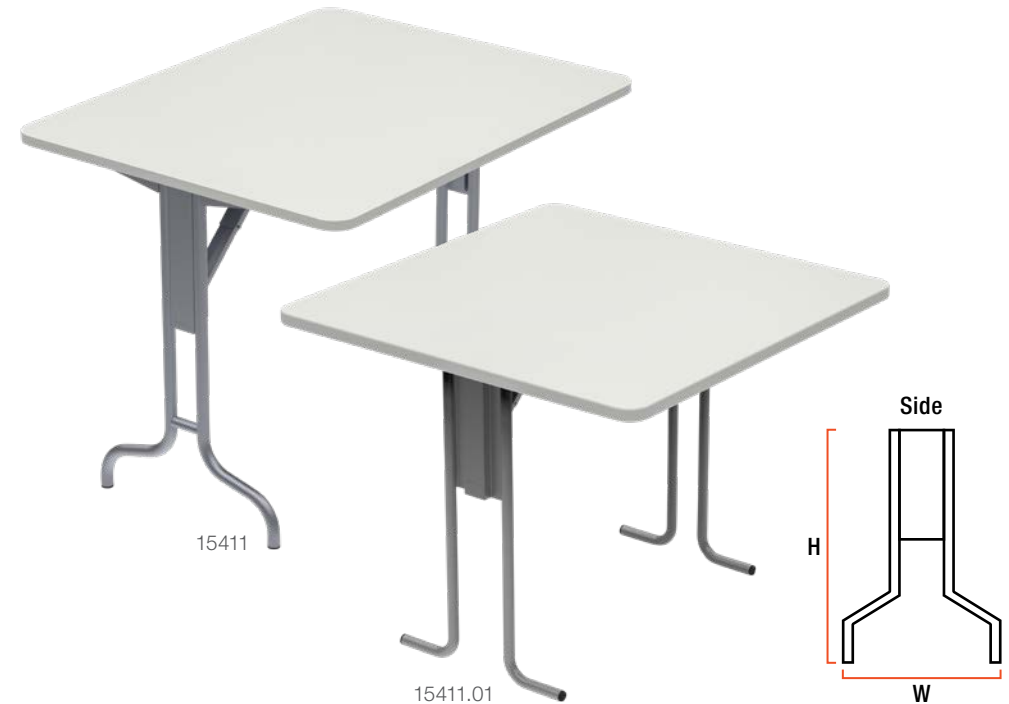

Part #	Foot	↕ H	↕ H1	↕ W	↕ W1	↕ W2	↕ W3	↕ Foot Size
2021104524	Simple	720 mm	380 mm	70 mm	33 mm	375 mm	235 mm	235 x 38 mm
2021104547	Wheeled	720 mm	380 mm	70 mm	33 mm	375 mm	235 mm	235 x 38 mm

Part #	Name	Includes	↕ H	↕ W
2021104556	Stabilious	Two legs	700 mm	450 mm
2021104518	Stabilious Evo	Two legs	700 mm	455 mm

STAR

Table leg | Folding

Star 1

- Extruded, anodized aluminum leg to be strong and lightweight
- Rectangular tube profile
- Die-cast aluminum hinge and galvanized steel top plate for maximum strength
- Customizable hinge position



Top-fold design for compact, as-needed storage

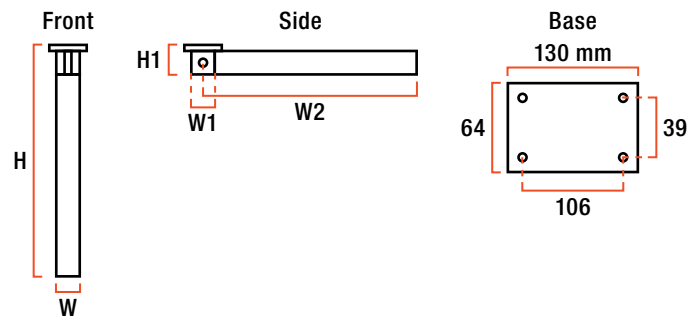

Star 2

- Extruded, anodized aluminum leg to be strong and lightweight
- Rectangular tube profile
- Die-cast aluminum hinge and galvanized steel top plate for maximum strength
- Dual-leg configuration with bottom foot for enhanced stability
- Customizable hinge position

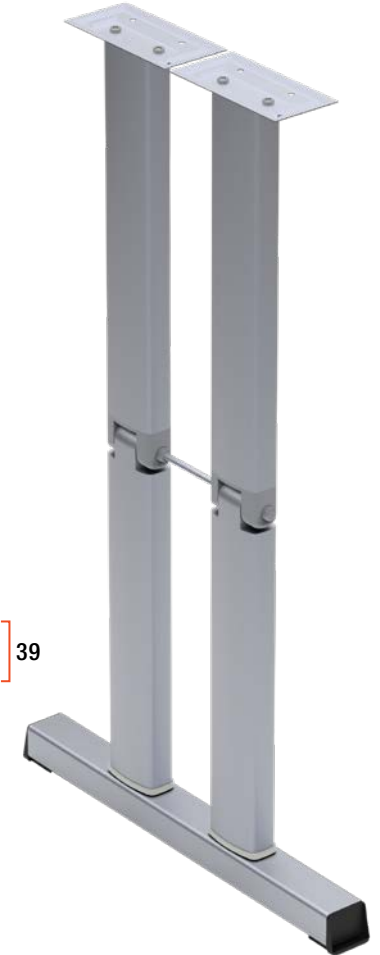
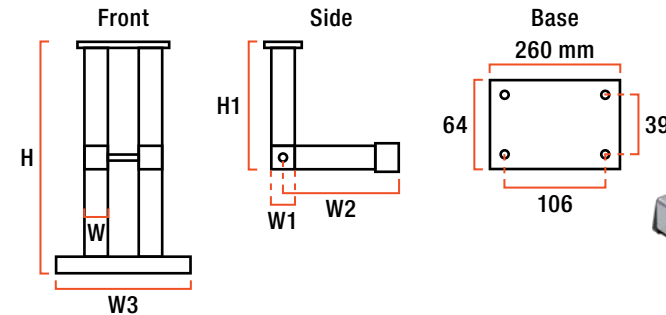

Part #	Foot	↕ H	↕ H1	↕ W	↕ W1	↕ W2
2021104539	Simple	720 mm	75 mm	60 mm	32 mm	670 mm

Part #	Foot	↕ H	↕ H1	↕ W	↕ W1	↕ W2	↕ W3
2021104540	Simple	720 mm	380 mm	60 mm	32 mm	355 mm	435 mm

Star 3

- Extruded, anodized aluminum leg to be strong and lightweight
- Rectangular tube profile
- Die-cast aluminum hinge and galvanized steel top plate for maximum strength
- Customizable hinge position
- Adjustable foot to ensure level table surface

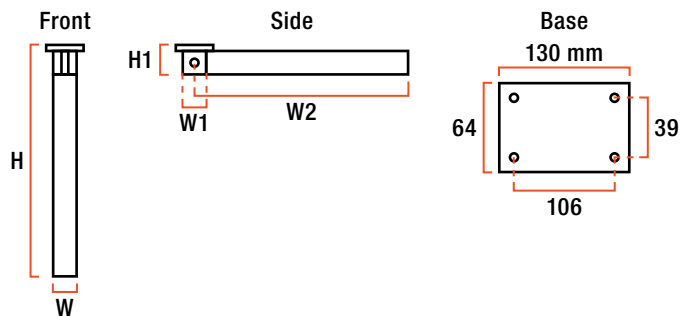

Part #	Foot	↕ H	↕ H1	↕ W	↕ W1	↕ W2
2021104542	Adjustable	720 mm	75 mm	60 mm	32 mm	670 mm

Star 4

- Extruded, anodized aluminum leg to be strong and lightweight
- Rectangular tube profile
- Die-cast aluminum hinge and galvanized steel top plate for maximum strength
- Bottom foot for increased stability

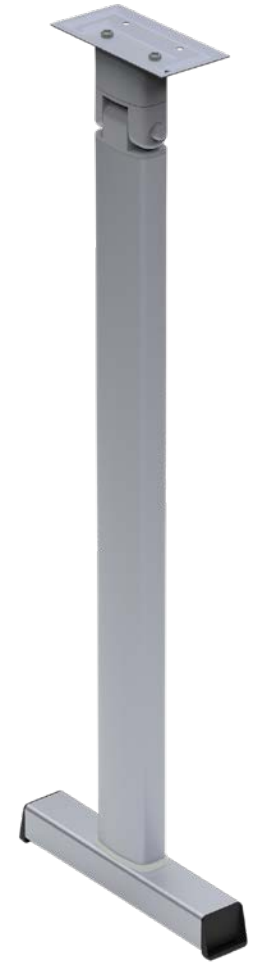
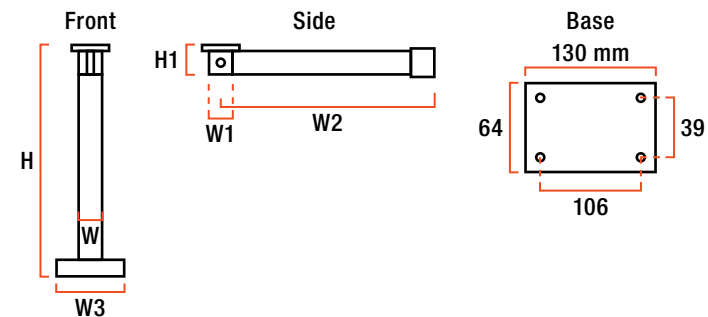

Part #	Foot	↕ H	↕ H1	↕ W	↕ W1	↕ W2	↕ W3
2021104536	Simple	720 mm	75 mm	60 mm	32 mm	670 mm	235 mm

STAR

Table leg | Folding

Star 5

- Extruded, anodized aluminum leg to be strong and lightweight
- Rectangular tube profile
- Die-cast aluminum hinge and galvanized steel top plate for maximum strength
- Telescoping bottom leg to ensure level table surface
- Customizable hinge position

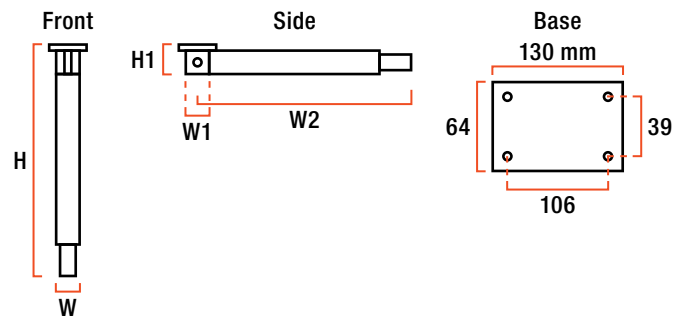
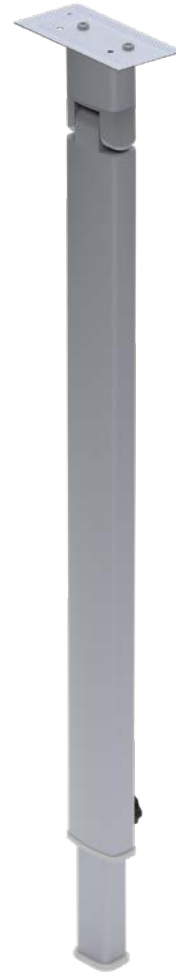

Part #	Foot Style	↕ H	↕ H1	↕ W	↕ W1	↕ W2
2021104525	Telescopes	650 to 750 mm	75 mm	60 mm	32 mm	600 to 700 mm

Star 6

- Top-fold design for compact table as-needed storage
- Leg separates from hinging base for additional breakdown
- Extruded, anodized aluminum leg to be strong and lightweight
- Rectangular tube profile for a sturdy, functional accent
- Die-cast aluminum hinge and galvanized steel top plate for maximum strength

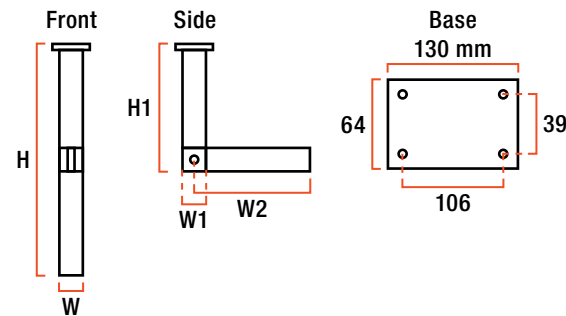

Part #	Foot	↕ H	↕ H1	↕ W	↕ W1	↕ W2
2021104530	Simple	720 mm	380 mm	60 mm	32 mm	355 mm

Star 7

- Center-fold design for compact table as-needed storage
- Extruded, anodized aluminum leg to be strong and lightweight
- Rectangular tube profile for a sturdy, functional accent
- Die-cast aluminum hinge and galvanized steel top plate for maximum strength

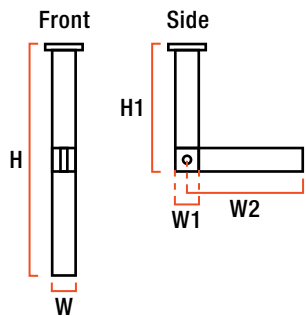
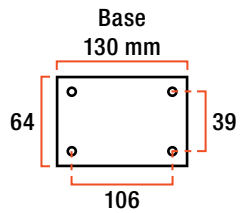

Part #	Foot	↕ H	↕ H1	↕ W	↕ W1	↕ W2
2021104560	Simple	720 mm	380 mm	60 mm	32 mm	355 mm

Star 8

- Extruded, anodized aluminum leg to be strong and lightweight
- Rectangular tube profile
- Die-cast aluminum hinge and galvanized steel top plate for maximum strength
- Telescoping bottom leg to ensure level table surface
- Customizable hinge position
- Bottom foot for increased stability

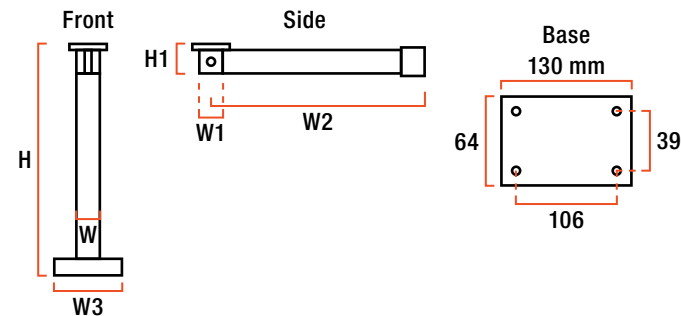

Part #	Foot	↕ H	↕ H1	↕ W	↕ W1	↕ W2	↕ W3
2021104557	Telescopes	650 to 750 mm	75 mm	60 mm	32 mm	600 to 700 mm	235 mm



MITO

Table support | Sliding

- Provides an adjustable bracket system to mount the table
- Sliding brackets easily adjust to accept different table dimensions
- Plastic and anodized aluminum construction for smooth operation



Provides an adjustable bracket system to mount the table

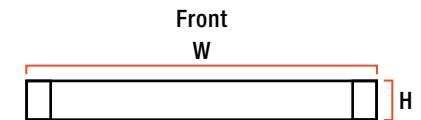

Part #	Name	Description	↻ W	↻ H
2021104684	Mito	Table kit	950 mm	35 mm
2021104681	Mito Hang	Replacement table attachment brackets	--	--
2022403213	--	Replacement mounting hardware and covers	--	--

PIN

Table support | Sliding

- Provides a solid mount for attaching the table to the wall
- Sliding brackets easily adjust to accept different table dimensions
- Plastic and stainless steel construction for smooth operation

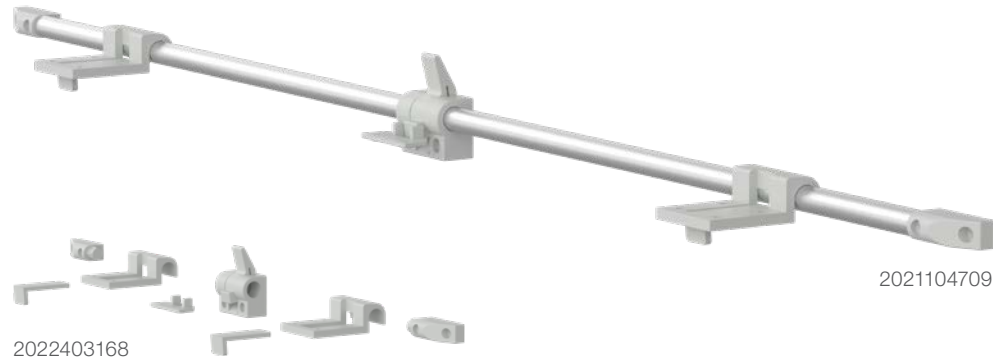

2022403168

2021104709

Front
W



Part #	Name	Description	↕ W	↕ H
2021104709	Pin	Table kit	1.040 mm	47 mm
2022403168	--	Replacement mounting hardware	--	--

STILO

Table support | Sliding

- Provides an adjustable bracket system to mount the table
- Sliding brackets easily adjust to accept different table dimensions
- Plastic and anodized aluminum construction for smooth operation

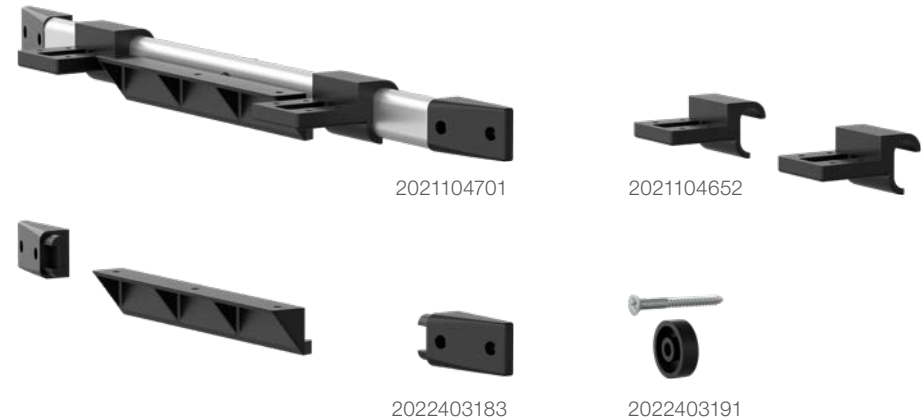

2021104701

2021104652

2022403183

2022403191



Allows table to be put up and down as needed

Front
W



Part #	Name	Description	↕ W	↕ H
2021104701	Stilo	Table kit	1.062 mm	31 mm
2021104652	Stilo Hang	Replacement table attachment brackets	--	--
2022403191	--	Replacement spacer and screw	--	--
2022403183	--	Replacement mounting hardware	--	--

JIMMY

Table support | Sliding

- Supports table extension to fully optimize interior space
- Plastic and aluminum slide components for smooth operation
- Includes two adjustable supports

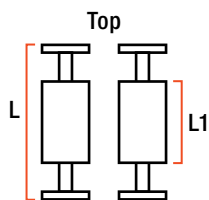

Part #	↔ L	↕ L1
2022110418	180 mm	91 mm
2022013466	220 mm	91 mm
2021104633	250 mm	91 mm
2022110421	300 mm	91 mm
2022105600	350 mm	91 mm
2022110423	400 mm	91 mm

SIMPLY

Table support | Sliding

- Allows table to slide as needed to fully optimize interior space
- Steel and aluminum construction to be strong and lightweight
- Table leg not included



Easy-to-grip handle allows for quick and easy adjustment



Steel and aluminum materials are strong and lightweight



Slides in two directions to provide maximum adjustability

Part #	↕ Width Adjustment Range	↕ Depth Adjustment Range
2021104680	420 mm run	300 mm run

ASTRA

Table support | Extending

- Allows table to slide out as needed to fully optimize interior space
- Plastic and aluminum slide components for smooth operation



Part #	↕ H	↔ W	↕ L	↔ L1
2021104632	35 mm	560 mm	850 mm	1.300 mm

FOCUS

Table support | Extending

- Allows table to slide out as needed to fully optimize interior space
- Plastic and aluminum slide components for smooth operation



Allows table to slide out as needed

Smooth, sliding operation for delicate situations

Part #	↕ H	↔ W	↕ L	↔ L1
2021104698	25 mm	560 mm	870 mm	1.500 mm

TIRETTE

Table support | Extending

Tirette 1

- Fixed mechanisms are 260 mm apart
- Allows table to extend out as needed to fully optimize interior space
- Steel construction for maximum strength

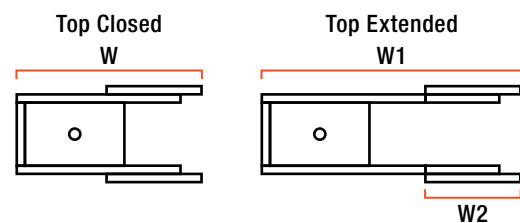
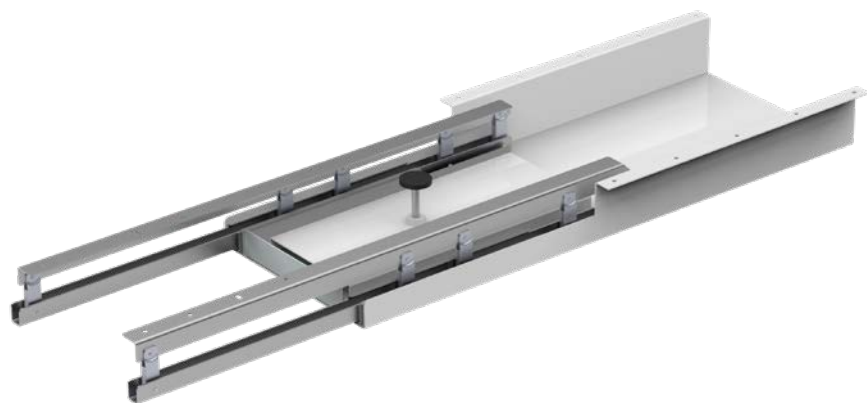

Part #	↕ W	↕ W1	↕ W2
2021104688	630 mm	980 mm	260 mm

Tirette 2

- Two separate mechanisms allow mounting for multiple table widths
- Allows table to extend out as needed to fully optimize interior space
- Steel construction for maximum strength

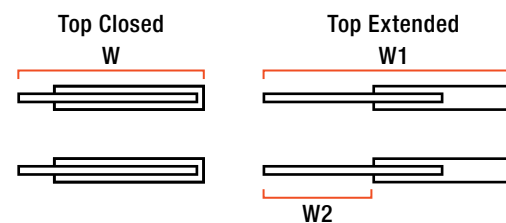

Part #	↕ W	↕ W1	↕ W2
2021104707	630 mm	980 mm	260 mm

TABLE LEGS



TABLE LEGS



WATER TANKS





Lippert water tanks are available in a wide variety of shapes and sizes to provide an exact fit for campervans and caravans. They're constructed from high-quality plastic and are designed to integrate with the existing structure of the vehicle.

WATER TANKS

Water tank I Rotational molding

- NOTICE: If installation pipes and vents are not installed from the top of the water tank, capacity of the tank could be reduced by up to 6%
- Constructed from high-density polyethylene
- Compatible with a variety of caravans and motorcaravans
- Installation hardware not included
- Available in black and white (other colors available on request)
- Full assembly and single sub-components comply with KTW-BWGL and DIN 16421



White #	Black #	Litres	↕ H	↕ W	↕ L
2021104405	2021104337	42.2	400	480	250
2021104399	2021104328	49.8	460	680	190
2021104374	2021104358	60.8	330	740	280
2021104383	2021104362	68.4	460	680	230
2021104389	2021104354	72	550	1.040	130
2021104349	2021104363	79*	400	550	360
2021104406	2021104366	74.4	400	500	400
2021104415	2021104344	84*	400	700	300
2021104409	2021104320	72	480	880	200
2021104375	2021104359	106	400	800	350
2021104384	2021104317	102.2	550	1.040	210
2021104390	2021104364	110.2	480	880	300
2021104400	2021104355	57.2	380	770	220
2021104350	2022122489	63.4	380	880	220
2021104391	2021104318	72	380	1.000	220
2021104395	2021104356	79.2	380	1.120	220
2021104379	2021104322	103*	380	1.230	220
2021104376	2021104319	16.6	400	500	120
2021104416	2021104448	28.2	400	800	120
2021104401	2021104498	36	400	1.000	120
2021104351	2021104473	43.2	400	1.200	120
2021104385	2021104507	72	450	650	280
2021104377	2021104513	112*	450	900	280
2021104380	2021104460	110	450	1.000	280
2021104396	2021104482	134.6	450	1.200	280
2021104410	2021104432	42.4	280	810	200
2021104402	2021104499	60*	280	1.120	200
2021104386	2021104474	65.2	280	1.310	200
2021104352	2021104483	129.2	550	750	340
2021104397	2021104449	77*	480	800	200
2021104378	2021104514	82.6	580	800	200
2021104381	2021104433	95.8	680	800	200
2021104411	2021104461	107.2	680	550	310
2021104387	2021104508	36.2	980	260	170
2021104403	2021104500	49.2	1.300	260	170
2021104353	2021104475	65.8	830	360	270
2021104392	2021104515	81.6	1.000	360	270
2021104370	2021104450	107.2	1.300	360	270

White #	Black #	Litres	↕ H	↕ W	↕ L
2021104332	2021104484	142.8	1.600	360	270
2021104412	2021104509	46	1.000	310	230
2021104338	2021104462	86.4	1.290	310	230
2021104323	2021104434	118*	1.600	310	230
2021104393	2021104501	35.4	610	310	230
2021104371	2021104451	41	500	360	270
2021104345	2021104516	40.2	480	330	300
2021104333	2021104479	57.8	680	330	300
2021104324	2021104504	79.2	880	330	300
2021104339	2021104476	104	1.120	330	300
2021104394	2021104465	32	550	370	180
2021104329	2021104429	48.4	800	370	180
2021104346	2021104502	60.8	1.050	370	180
2021104372	2021104505	86*	1.300	390	210
2021104334	2021104510	90	650	550	280
2022454072	2021104452	40.2	650	750	280
2021104335	2021104480	152.4	650	950	280
2021104340	2021104477	175.4	650	1.150	280
2021104330	2021104430	55*	500	550	200
2021104347	2021104466	101.4	500	1.150	200
2022013479	2021104506	57.4	300	800	280
2021104326	2021104511	68.4	300	1.000	280
2021104341	2021104503	100*	300	1.200	280
2021104360	2021104453	102.4	300	1.400	280
2021104331	2021104478	95.2	700	650	230
2021104368	2021104481	92.6	750	400	350
2021104336	2021104463	50.4	750	400	200
2021104342	2021104431	100	900	590	220
2021104327	2021104512	113	1.400	500	190
2021104357	2021104488	94*	600	200	800
2021104361	2021104495	85.6	800	200	600
2021104365	2021104464	47.4	550	200	500
2021104369	2021104470	84*	950	200	450
2021104343	2021104445	33.6	200	300	700

All dimensions are listed in mm

* The actual capacity of the tank may reduce by up to 6%, while adhering to all installation guidelines (incorporating vents and pipelines) to ensure the correct filling of the tank



PLUG

Water tank | Accessory

- Fits all Lippert water tanks
- Made of nylon



2021104438



2021104489

Part #	Style	↕ Dimensions
2021104438	Male	125 mm
2021104489	Female	140 mm

GASKET

Water tank | Accessory

- Fits Lippert male (#2021104438) and female (#2021104489)
- Made of neoprene for black tanks and FDA-approved polyethylene for white tanks



2021104485



2023038726

Part #	For	↕ Dimensions
2021104485	Male / female plugs	125 mm
2023038726	White tanks	125 mm

EXPANSION CAP

Water tank | Accessory

- Hinging lever expands rubber to plug tank (#2021149767)
- Insertion of these components will reduce the actual capacity of the tank where it is inserted



2022112413



2021149767

Part #	Description	↕ Dimensions
2021149767	Expansion cap	22 mm
2022112413	Expansion cap extension	--



POWER ON BOARD





A steady, onboard power supply is an essential part of mobile travel. Charging systems from Lippert enable batteries to be perfectly charged and onboard electrical devices to be supplied with power in all situations.



EMPOWERING YOUR ADVENTURES

Experience seamless power management with our range of cutting-edge products. Our boosters, caravan power supplies, and electroblocks ensure efficient charging and reliable voltage for all your electrical devices. Advanced water tank level probes, solar regulators, and lighting control systems deliver precise power control, while our operation and display panels keep you informed. With specialized peripheral devices, Lippert addresses all your power needs for a comfortable journey.

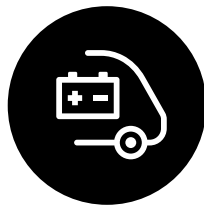

Boosters

Intelligent charging with a boost

A device for boosting the current supplied by the vehicle (towing vehicle) to facilitate charging the living area battery while driving (supply voltage drop via the trailer socket can be very high). Device for boosting the voltage supplied by the vehicle (chassis) to facilitate charging the living area battery while driving (i.e. EURO6 alternators only supply 13V or less under certain operating conditions).

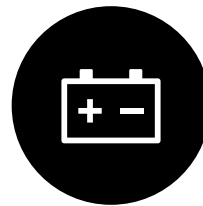

Caravan Power Supplies

All necessary power for caravan utilities

Devices generating a battery charging voltage in the caravan, alternatively supply voltage only without. Charging function (characteristic curve) distribution and protection of output circuits; overall supply switching via a main switch. They are suitable for caravans that do not have their own battery, but have electrical devices that are supposed to be operated solely via the campsite's mains power supply.

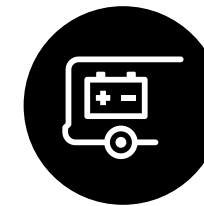

Electroblocks

Max performance and system availability

Devices for generating charging voltages for all batteries installed in the motorcaravan (living area, starter, or auxiliary battery). EBLs distribute and protect the output circuits. The overall supply switching is via two main switches, the living area supply on / off switch and the vehicle supply on / off switch with complete isolation of all consumers from the batteries (shutdown).

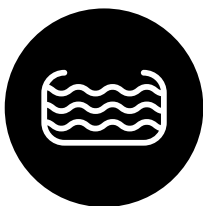

Water Tank Level Probes

Level up to optimal measurements

Probes to acquire levels in water tanks or wastewater tanks.

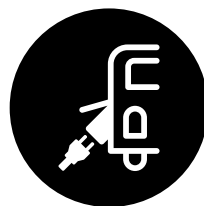

Chargers

Top rated, compact charging performance

Device for boosting the current supplied by the EBL (additional charger) or as a simple battery charger without voltage distribution.

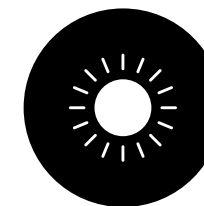

Solar Regulators

Optimal conversion of solar rays

Device to facilitate connecting one or more solar panels. A charging voltage for one living area battery or two batteries (living area and starter battery) is available at the output. Charging voltage suitable for batteries, voltage and current display can be connected.



Lighting Control Systems

Master light in the darkness

Lighting control systems for switching and dimming various light sources such as LEDs, RGB stripes, WW/CW stripes and incandescent lamps. One or more channels per device.

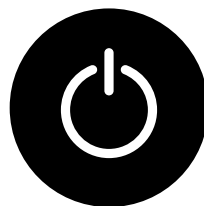

Operation & Display Panels

Discover an intuitive way of operating

Panels are designed to display vehicle data (tank levels, currents, operating states, status messages, temperatures, etc). Some panels allow operation of Lippert devices and systems and control / switching of third-party devices and systems.



Peripheral Devices

Ultimate caravan automation

Special devices developed by Lippert are available for various control or monitoring tasks. These devices are customized to the specific requirements in close cooperation with the OEMs.



WA 1208

Booster I Caravan

- Increases the charging voltage in the caravan so the caravan battery can be charged when driving
- Cut-off from towing vehicle when ignition is switched off
- Voltage compensation of fluctuating alternator voltage
- Selectable IU charging curve for the living area battery (two)
- Status info via LED
- D+ evaluation



Part #	Output Current	Max Input Current	Input Voltage	Output Voltage	Reverse Current Caravan Battery	Operation Ambient Temp.
2021104721	8 A	9 A	9 to 14,5V DC	14,4V	< 0,5mA*	-20° < +45°

* With ignition off or engine off

Position	↕ Height	↔ Width	↔ Depth	📦
Caravan	54 mm	95 mm	148 mm	250 gr



WA 121525

Booster I Motorcaravan

When using an energy-saving charging alternator (Euro 6), using a booster is required because the charging voltage fluctuates very strongly (12,6V to 15V). When using a conventional alternator, the living area battery charge can be improved by using a booster.

- Charges 12V lead-acid, lead-gel, AGM, and lithium batteries while driving, regardless of alternator voltage
- Selectable characteristic curves can be any combination of lead-acid, lead-gel, AGM I, AGM II, lithium (CCCV)
- Charging characteristic curve: IUoU (current-dependent switchover to trickle charge)
- Bypass switch to facilitate starter battery charging when the connected electroblock is in grid mode
- Adjustable / curve-controlled charging current limitation / power limitation
- Charging current temperature compensation
- Current is adjustable in four increments: 45 A, 55 A, 63 A and 70 A
- Overheating protection
- D+ controlled



Part #	Output Current	Max Input Current	Input Voltage	Output Voltage	Reverse Current Caravan Battery	Operation Ambient Temp.
2021104722	< 30 A	28 A	12 V for max output current	< 15 V (adjustable)	< 0,4mA*	-20° < +45°

* With ignition off or engine off

Position	↕ Height	↔ Width	↔ Depth	📦
Motorcaravan	54 mm	95 mm	148 mm	410 gr



WA 121545

Booster I Motorcaravan

When using an energy-saving charging alternator (Euro 6), using a booster is required because the charging voltage fluctuates very strongly (12,6V to 15V). When using a conventional alternator, the living area battery charge can be improved by using a booster.

- Charges 12V lead-acid, lead-gel, AGM, and lithium batteries while driving, regardless of alternator voltage
- Selectable characteristic curves can be any combination of lead-acid, lead-gel, AGM I, AGM II, lithium (CCCV)
- Charging characteristic curve: IUoU (current-dependent switchover to trickle charge)
- Bypass switch to facilitate starter battery charging when the connected electroblock is in grid mode
- Adjustable / curve-controlled charging current limitation / power limitation
- Charging current temperature compensation
- Current is adjustable in four increments: 45 A, 55 A, 63 A and 70 A
- Overheating protection
- D+ controlled



Part #	Output Current	Max Input Current	Input Voltage	Output Voltage	Reverse Current Caravan Battery	Operation Ambient Temp.
2021104771	< 70 A	65 A	12 V for max output current	< 15 V (adjustable)	< 0,4mA*	-20° < +45°

* With ignition off or engine off

Position	↕ Height	↔ Width	↔ Depth	🛒
Motorcaravan	169 mm	72 mm	193 mm	1,150 gr





CSV 300

Caravan Power Supply

Power supply units supply 12V equipment such as immersion pumps, fans, lights and similar devices. They are most commonly used for caravans connected to a 230V network and power the utilities from the vehicle battery for a limited amount of time.

- For operation without battery
- Five separately fused 12V current circuits
- Installation space (mounting rail 35 mm, 4TE) for 230V basic distribution available
- Priority circuit for mains supply, otherwise supply of utilities from the car battery
- Low quiescent current consumption

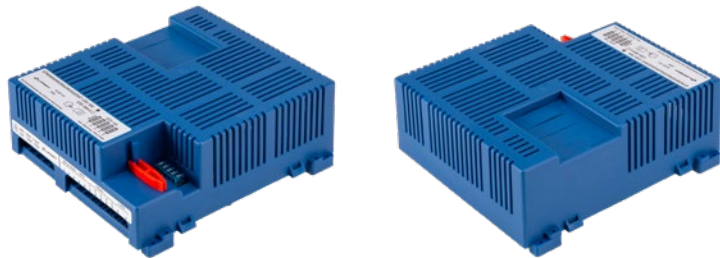

Part #	Input Voltage	Max Total Current	Charging Current	Output Voltage	Output Range	Operation Ambient Temp.
2021104770	230 V mains 12 V from tow vehicle	24 A	N/A	12V	15 A	-20° < +45°

Position	↕ Height	↔ Width	↔ Depth	🛒
Caravan	84 mm	210 mm	227 mm	1.300 gr

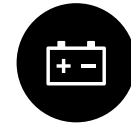

CSV 400

Caravan Power Supply

Power supply units supply 12V equipment such as immersion pumps, fans, lights and similar devices. They are most commonly used for caravans connected to a 230V network and power the utilities from the vehicle battery for a limited amount of time.

- Output voltage 12,5V DC, output current 32 A
- Six separately fused 12V current circuits
- Priority circuit for mains supply, otherwise supply of utilities from the car battery
- Output voltage stabilized and screened
- Connection option for water tank monitoring control panel
- Connection option for refrigerator supply



Part #	Input Voltage	Max Total Current	Charging Current	Output Voltage	Output Range	Operation Ambient Temp.
2021104728	230 V mains 12 V from tow vehicle	32 A	N/A	12V	2 A < 15 A	-20° < +45°

Position	↕ Height	↔ Width	↔ Depth	🛒
Caravan	111 mm	320 mm	217 mm	1.700 gr



CSV 409

Caravan Power Supply | Battery charger

Intended for use in autarkic caravan, our battery charging module features complete 12V distribution, fuse protection of the 12V current circuits, as well as other control and monitoring functions.

- Battery charging through 230V supply with 28 A, characteristic curve IUoU
- Selectable characteristic curves are lead acid or lead gel
- 8 A charging booster for battery charging while driving
- Bistable mains latching relay (12V)
- Connection facility for solar controllers LR 1218 and LRM 1218
- Automatic switch-off of utilities when ignition is switched on
- Battery charging from grid or while driving
- Selectable characteristic curves are lead acid or lead gel
- Refrigerator supply (configurable) for absorber, compressor, or AES refrigerators
- Low quiescent current consumption
- Also available with an analog panel



Part #	Input Voltage	Max Total Current	Charging Current	Output Voltage	Output Range	Operation Ambient Temp.
2021104731	230 V mains 12 V from tow vehicle	28 A	28 A	12V	5 A < 15 A	-20° < +45°

Position	↕ Height	↔ Width	↔ Depth	📦
Caravan	111 mm	320 mm	217 mm	2.000 gr

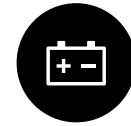

CSV 412

Caravan Power Supply | Battery charger

Intended for use in autarkic caravan, our battery charging module features complete 12V distribution, fuse protection of the 12V current circuits, as well as other control and monitoring functions.

- Battery charging through 230V supply with 28 A, characteristic curve IUoU
- Selectable characteristic curves are lead acid or lead gel
- 8 A charging booster for battery charging while driving
- Bistable mains latching relay (12V)
- Connection facility for solar controllers LR 1218 and LRM 1218
- Automatic switch-off of utilities when ignition is switched on
- Battery charging from grid or while driving
- Selectable characteristic curves are lead acid or lead gel
- Refrigerator supply (configurable) for absorber, compressor, or AES refrigerators
- Low quiescent current consumption
- Also available with an analog panel



Part #	Input Voltage	Max Total Current	Charging Current	Output Voltage	Output Range	Operation Ambient Temp.
2024030897	230 V mains 12 V from tow vehicle	28 A	28 A	12V	5 A < 15 A	-20° < +45°

Position	↕ Height	↔ Width	↔ Depth	📦
Caravan	111 mm	320 mm	217 mm	2.000 gr

POWER ON BOARD





EBL 150

Electroblock I Motorcaravan

NEW



M SERIES

Water tank level probe

- Devices for generating charging voltages for all batteries installed in the motorcaravan (living area, starter, or auxiliary battery)
- EBLs distribute and protect the output circuits
- The overall supply switching is via two main switches (MOSFETS)
- The living area supply on / off switch and the vehicle supply on / off switch with complete isolation of all consumers from the batteries (shutdown)
- Connection facility for solar charge controller (up to 25 A charging current)
- Refrigerator supply (configurable) for absorber, compressor, or AES refrigerators
- IUoU, integrated charging output with adjustable slide switch for lithium and AGM
- Low quiescent current consumption
- D+ signal evaluation

- Four levels
- Includes nut and seal



Part #	Input Voltage	Max Total Current	Charging Current	Output Voltage	Output Range	Operation Ambient Temp.
2024030896	230 V mains 12 V from tow vehicle	18 A	18 A	12V	5 < 25 A	-20° < +45°

Position	↕ Height	↔ Width	↔ Depth	📦
Motorcaravan	130 mm	275 mm	170 mm	2.000 gr

Part #	Model #	Position	Operation Ambient Temperature	↕ Diameter	↕ Length
2024041017	M315	Caravan / Motorcaravan	-20° < +45°	60 mm	250 mm
2024041018	M345	Caravan / Motorcaravan	-20° < +45°	60 mm	300 mm
2024041019	M388	Caravan / Motorcaravan	-20° < +45°	60 mm	350 mm
2024041020	M465	Caravan / Motorcaravan	-20° < +45°	60 mm	400 mm
2024041021	M590	Caravan / Motorcaravan	-20° < +45°	60 mm	450 mm
2024041022	M570-20	Caravan / Motorcaravan	-20° < +45°	60 mm	500 mm
2024041023	M610	Caravan / Motorcaravan	-20° < +45°	60 mm	500 mm
2024041024	M625	Caravan / Motorcaravan	-20° < +45°	60 mm	550 mm



POWER ON BOARD



LAS 1218-2

Charger | Caravan or motorcaravan

- Selectable characteristic curves is: lead-acid or lead-gel
- Overheating and overcurrent protection
- Connectors of all ports can be defined by OEM
- WAGO plug 230V available



LAS 1218-L

Charger | Caravan or motorcaravan

NEW

- Selectable characteristic curves is: AGM or lithium
- Overheating and overcurrent protection
- Connectors of all ports can be defined by OEM
- WAGO plug 230V available



Part #	Max Input Current	Input Voltage	Charging Current	Output Voltage	Operation Ambient Temp.
2021104740	1.9 A	230V	18 A	14.3V	-20° < +45°

Part #	Max Input Current	Input Voltage	Charging Current	Output Voltage	Operation Ambient Temp.
2024030898	1.9 A	230V	18 A	14.3V	-20° < +45°

Position	↕ Height	↔ Width	↔ Depth	📦
Caravan / Motorcaravan	90 mm	148 mm	248 mm	1.000 gr

Position	↕ Height	↔ Width	↔ Depth	📦
Caravan / Motorcaravan	90 mm	148 mm	248 mm	1.000 gr



LRM 1218

Solar regulator | Caravan or motorcaravan

This clocked regulator ensures the connected solar modules are always properly functioning while the battery is in the mains charging phase, regardless of solar radiation, battery voltage, and module temperature.

- Easily adjust the charging voltage for the living area battery through the setting options and optional temperature sensor
- Supports up to 20 A for living area batteries and 2.5 A for starter batteries
- Works with 12V lead-acid, AGM, or lead-gel batteries
- Charging range is 13.2V to 14.9V and is temperature controlled
- SDTBUS capable



Part #	Output Current	Supply Voltage	Max Input Power	Output Voltage	Operation Ambient Temp.
2021104717	18 A	12V	275 Wp	14.4 / 14.7V	-20° < +45°

Position	Height	Width	Depth	Product Weight
Caravan / Motorcaravan	54 mm	95 mm	148 mm	410 gr

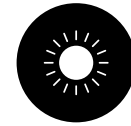

LR 1218

Solar regulator | Caravan or motorcaravan

This regulator limits and regulates the charging voltage from the solar modules. It ensures up to two batteries are partially charged.

- Built-in isolation diode prevents discharge if the charging voltage is insufficient, in the dark for example
- Suitable for six-cell 12V lead acid or lead-gel batteries
- End-of-charge voltage for both batteries 14,2V, characteristic curve: IU
- Longitude controller
- Battery connection via AMP 6.3 flat connectors



Part #	Output Current	Supply Voltage	Max Input Power	Output Voltage	Operation Ambient Temp.
2021104720	18 A	12V	275 Wp	14.2V	-20° < +45°

Position	Height	Width	Depth	Product Weight
Caravan / Motorcaravan	61 mm	75 mm	110 mm	116 gr

POWER ON BOARD



LIPPERT

POWER ON BOARD



LIS 101

Lighting control system

- One light channel per device
- Over-current shutdown (electronic)
- Over-temperature shutdown
- Short circuit protection



Part #	Output Current	Supply Voltage	Max Input Current	Output Voltage	Output Range	Operation Ambient Temp.
2021104723	10 A	12V	10 A	12V	10 < 100 PWM	-20° < +45°

Position	↕ Height	↔ Width	↔ Depth	📦
Caravan / Motorcaravan	23 mm	68 mm	57 mm	40 gr



LIS 102

Lighting control system

- Two light channels per device
- Over-current shutdown (electronic)
- Over-temperature shutdown
- Short circuit protection



Part #	Output Current	Supply Voltage	Max Input Current	Output Voltage	Output Range	Operation Ambient Temp.
2024030899	2 x 6 A	12V	12 A	12V	10 < 100 PWM	-20° < +45°

Position	↕ Height	↔ Width	↔ Depth	📦
Caravan / Motorcaravan	23 mm	68 mm	57 mm	40 gr

POWER ON BOARD



LIS 204

Lighting control system

- Four light channels per device
- Panels, keys, digital panels
- Over-current shutdown (electronic)
- Over-temperature shutdown
- Short circuit protection



Part #	Output Current	Supply Voltage	Max Input Current	Output Voltage	Output Range	Operation Ambient Temp.
2024030900	4 x up to 5 A	12V	14 A	12V	10 < 100 PWM	-20° < +45°

Position	↕ Height	↔ Width	↔ Depth	🛒
Caravan / Motorcaravan	50 mm	85 mm	100 mm	75 gr





LT 453

Operation and display panel

- For use with EBL 150, EBL 208, and EBL 211
- Indication and operation options: sensor panel
- Analog indication via LED bars (rectangular, round, almost any scale design possible)
- Direct water pump and direct consumer switching
- Grid voltage present display (shore power)
- Parallel cabling on EBL
- Back-printed acrylic front panel
- Clip fasteners

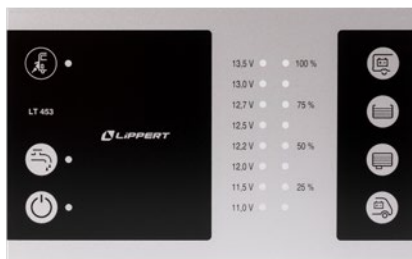

Part #	Supply Voltage	Operation Ambient Temperature
2024041014	12V	-10° < +50°

Position	↕ Height	↔ Width	↔ Depth	🛒
Caravan / Motorcaravan	25 mm	112 mm	118 mm	100 gr



LT 97

Operation and display panel

- For use with EBL 150
- Operation via mechanical on / off push buttons
- Grid voltage present display (shore power)
- Parallel cabling on EBL
- Back-printed acrylic front panel
- Screw or clip fasteners



Part #	Supply Voltage	Operation Ambient Temperature
2024041015	12V	-10° < +50°

Position	↕ Height	↔ Width	↔ Depth	🛒
Caravan / Motorcaravan	55 mm	115 mm	150 mm	120 gr



DT 740

Operation and display panel

NEW



LT 320

Operation and display panel

- For use with EBL e-SMARTWAVE only
- Indication and operation via 7" touch screen
- Customized display pages include, but are not limited to: living area, starter battery voltage, charging current, and water / wastewater tank levels
- Control of external devices (panels with display only), e.g. heating, air conditioning, lighting systems (controllable dimming and color)
- Direct water pump and direct consumer switching
- Grid voltage present display (shore power)
- Status message display
- Fault code display (bus systems only)
- Parameter setting (e.g. battery curve (bus systems only))
- Bus connection via LIN (CI bus)
- Display panels with frame and concealed fasteners
- Screw fasteners

- Connects directly to a Lippert solar regulator
- Displays the solar charging current for the living area or starter battery
- Compatible with the following Lippert solar regulators: LRM 1218, LR 1218



Part #	Supply Voltage	Operation Ambient Temperature
2024041013	12V	-10° < +50°

Part #	Supply Voltage	Operation Ambient Temperature
2024041016	12V	-10° < +50°

Position	↕ Height	↔ Width	↔ Depth	🛒
Caravan / Motorcaravan	22 mm	116 mm	185 mm	120 gr

Position	↕ Height	↔ Width	↔ Depth	🛒
Caravan / Motorcaravan	35 mm	110 mm	110 mm	75 gr



POWER ON BOARD



OVP 01

Peripheral devices

An overvoltage protector should be used to protect all devices on board a vehicle operated using 230V AC from overvoltage. It is important to note, particularly when visiting campsites in the Southern Hemisphere, that dislocated power supplies causing such overvoltage occur as a result of defective installations. There is also a risk of overvoltage on ferries and when operating power generators in particular.

- If overvoltage or undervoltage occurs, (U_{eff} : $<175V$ AC, $>265V$ AC), cut-off occurs within 10 milliseconds
- The devices remain switched off until the mains Voltage is normal
- Simply connected downstream of the motorhome's power plug (CEE)
- All devices supplied with mains voltage are protected



Part #	Output Current	Max Input Current	Input Voltages	Output Voltage	Operation Ambient Temp.
2021104719	8.5 A	8.5 A	230V AC	230V AC	-20° < +45°

Position	↕ Height	↔ Width	↔ Depth	📦
Caravan / Motorcaravan	47 mm	130 mm	90 mm	200 gr



ACCESSORIES





Lippert offers a number of electronics and specialty accessories to maximize functionality on any caravan or campervan. Check out our camera systems, cooler, solar panel, propane tank holder, stabilizing jacks, and more.

FURRION® VISION S®

Camera system kits



Monitors

- HD monitor with anti-glare display allows you to toggle between cameras
- Toggle between multiple camera views on the touchscreen monitor
- Low-profile design promotes an unobstructed view out of the windshield



Displays a clear image for up to four cameras for all-around coverage



Reliable, wireless communication with no lag between camera and monitor



Cameras

- Reliable digital connection (2.4GHz)
- High-resolution cameras
- Wide viewing angle with up to four cameras displayed
- Night vision and intelligent IR cut filter for clear viewing
- Motion detection and microphone promotes safety
- Security camera auto-wake with motion detection
- IP65 waterproof-rated cameras for durability
- HD monitor with anti-glare display
- Wireless cameras are easy to set up
- Rear park assist marker lines to align your vehicle



Increases visibility while backing the campervan or motorcaravan into a parking space or campsite



Provides 360-degree views for observation while driving so you can see all around you on the road

Part #	Furrion Model #	Monitor Size	Includes
2022447304	FOS05TANK	5"	Monitor
2022447305	FOS07TANK	7"	Side cameras (left & right) Doorway security / rear camera Windshield mount Interior table stand



Windshield mount

- Provides a convenient and reliable mounting point for sticking onto a hard, flat surface
- Compatible with all Furrion Vision S monitors
- Suction cup provides a sturdy mount with option to remove
- Allows angling of monitor to suit driver preferences
- Easy-to-use lever locking and release system



Provides a convenient mounting point for the monitor and allows pivoting as needed



Interior table stand

- Compatible with Furrion Vision S 5" and 7" monitors
- Provides a sturdy mount for positioning camera on a flat surface
- Allows angling of monitor to suit driver preferences



Pivoting mounting base for setting up the monitor on a flat surface

Camera specifications

Feature	Side	Doorway / Rear
Night vision distance	Up to <12 m	Up to <5 m
CMOS size	1/3"	1/3"
Optical lens	F2.5	F2.0
IR cut filter	850nm automatic	850nm automatic
View angle / degree	65°	120°
Work current (IR on)	<500mA@12V	<400mA@12V
Work current (IR off)	<250mA@12V	<250mA@12V
Camera pixel	720 x 480	720 x 480
Waterproof	IP65	IP65

Monitor specifications

Feature	5" Monitor	7" Monitor
Power off	<30mA@12V	<30mA@12V
Backlight on	<500mA@12V	<500mA@12V
Backlight off	<300mA@12V	<300mA@12V
Resolution at 1view	720 x 480	720 x 480
Brightness	420cd/m2	170cd/m2
Contrast	600 : 1	300 : 1
View angle	L/R65, U50, D60	L/R80, U60, D70
Aspect ratio	16:9	16:9
Channel bandwidth	20MHz	20MHz

Camera & monitor specifications

Feature	All
Supply voltage	DC8 to 30V
Wireless frequency	2.4GHz
Wireless range	Up to 150 m
Emitting power	18+/-2 dBm
Transmitting speed	6 Mbps
Receiving sensitivity	-88 +/-3dBm
Decompression form	H.264
Delaying time	< 250ms

FURRION® eROVE®

Electric cooler

- Iceless, portable electric cooler for camping, boating, and off-grid travels
- Capable of freezing to -22°C and holding ice for up to five days
- Four energy-saving modes keep food and drinks cold while completely off-grid
- Efficient 12V DC input provides a backup power source whenever you need it
- Features USB ports (two 2.0 / one 3.0) and wireless charging to keep your devices fully charged while on the go
- Interior LED lights, detachable cupholders, and umbrella holder for added convenience
- Compatible with the foldable 100W solar panel for a sustainable energy solution (sold separately)
- Includes a wheel kit for maximum mobility
- Compatible with the Furrion ePod® lithium-ion battery (sold separately)



eRove is capable of freezing to -22°C and keeping cooler contents chilled for up to five days



Easily switch between modes: beverage mode, freezer mode, eco-mode, and smart mode



USB ports keep your devices fully charged when using the ePod battery while on the go



Use with the foldable 100W solar panel for a modern and sustainable energy solution

Part #	Power	↕ Height	↔ Width	↔ Depth	📦	Holds	Includes
2023017500	12V DC	506 mm	906 mm	480 mm	28,9 kg	47.3 L or 72 cans	Serving tray, bottle opener, basket, umbrella holder, cupholder and wheel kit



FURRION EPOD®

Rechargeable battery

- Expandable, swappable design for versatile use
- Lithium-ion high-capacity battery
- Long-lasting shelf life storage
- Up to 500-cycle charging lifespan
- Overcurrent and overload protection
- Over discharge protection increases lifespan
- 400Wh capacity
- Lithium-ion cell chemistry
- Compatible with Furrion ePod® power station and Furrion eRove® electric cooler
- LED charge status indicators
- Rugged aluminum outer casing



Swappable lithium-ion battery for versatile use, (compatible with Furrion eRove® electric cooler)



Part #	Voltage	Current	↕ H	↕ W	↕ D	🛒
2023035502	14,4V	35 A	241 mm	141 mm	141 mm	4,3 kg

PRODUCT WEIGHT 🛒

DIMENSION ↕

FURRION® 100W

Folding solar panel

- Folding kickstand design is compact and lightweight for effortless setup anywhere
- Monocrystalline solar cells for high efficiency
- Up to 22% more efficient than polycrystalline
- High-transmittance bypass diodes
- Ultra-clear, low-iron tempered glass
- Short-circuit and surge protection safety features
- Waterproof construction
- Simply adjust the kickstand to be at a 90° angle with the sun for optimal solar radiation
- Compatible with LRM 1218 solar regulator



This versatile solar panel comes ready to use — just unfold and plug in your device



Part #	Power	↕ H	↔ W	↕ D	🛒
2023018477	100 watts	654 mm	394 to 1.221 mm	4 to 30 mm	4,7 kg

LRM 1218

Solar regulator

NEW

- Easily adjust the charging voltage for the living area battery through the setting options and optional temperature sensor
- Supports up to 20 A for living area batteries and 2.5 A for starter batteries
- Works with 12V lead-acid, AGM, or lead-gel batteries
- Charging range is 13.2V to 14.9V and is temperature controlled
- SDTBUS capable



Part #	Output Current	Supply Voltage	Max Input Power	Output Voltage	Operation Ambient Temp.
2021104717	18 A	12V	275 Wp	14.4 / 14.7V	-20° < +45°

Position	↕ Height	↔ Width	↕ Depth	🛒
Motorcaravan / Caravan	54 mm	95 mm	148 mm	410 gr

LEVEL9

Intuitive Leveling System

- Easy-to-use leveling system for maximizing comfort in your camper, motorhome, or van
- Offers precise leveling and effortless control for an enhanced outdoor living experience
- Features up to nine adjustable levels up to 18 cm high
- Intuitive smartphone app integration for iOS and Android provides precise directions for leveling the vehicle
- Polypropylene construction for compact and lightweight use
- Includes two wedges and a bag for easy wedge storage

KYLE
CAMPING
FOR **LIPPERT**

NEW

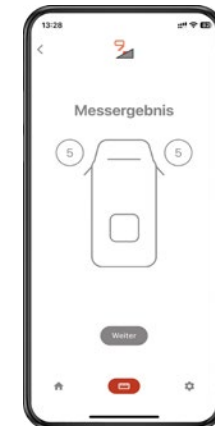
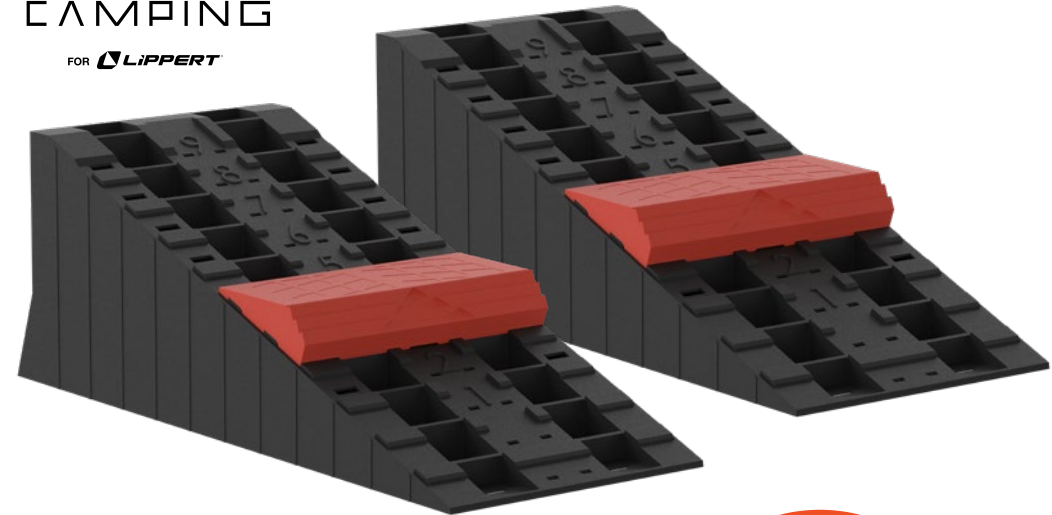

01 | USE THE APP TO MEASURE

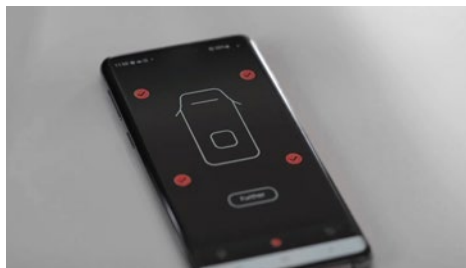

02 | ADJUST THE HEIGHT



03 | PLACE WEDGE & DRIVE UP



Part #	Weight	Load Capacity	L	W	H
2024026020	2,1 kg (each)	5 tons	550 mm	232 mm	200 mm



Download the app for
Apple iOS and Android OS

ACCESSORIES

GASSY

Propane tank sliding storage tray

- Holds two propane tanks up to 300 mm in diameter
- Convenient slide-out design makes changing propane bottles easy
- Equipped with magnets and a locking pin for stability during travel
- Mounts directly to the vehicle floor with self-tapping screws
- Easily secure the tank with the nylon cinching strap
- Tank spacer creates 30 mm of space between propane tanks to prevent rubbing and rattling (sold separately)
- Durable steel frame provides heavy-duty support



Sliding tray shown installed in cabinet
(cabinet and tanks not included)



Propane tank storage tray



Tank spacer



Replacement tank holder with spacer

Description	Holds	↕ Bottle Width	↕ Width	📦	📦
Available by request only					
Propane tank storage tray	Two propane bottles	300 mm	--	16,6 kg	40 kg
Propane tank spacer	--	--	30 mm	--	--
Replacement tank holder with spacer	--	250 mm or 310 mm	--	--	--

TOWELY

Hand towel holder

- Steel construction with a durable chrome finish
- Installation hardware not included



Part #	↕ W	↕ H	📦
2021104424	430 mm	205 mm	0,36 kg

STABILIZING JACK

- Stabilizing jacks help keep your trailer or camper level and steady
- Drop leg extends for convenient height adjustment
- Steel handle allows for easy height adjustment
- Large foot provides added stability
- Galvanized steel construction for heavy-duty strength and corrosion resistance
- Includes two jacks and one handle (hardware not included)



Part #	↕ Retracted Height	↕ Extended Height
2021104494	290 mm	450 mm
2021104469	390 mm	550 mm

PANEL CONNECTORS

- Replaces broken connectors on furniture
- Ideal for connecting furniture panels, cabinets, and beds
- Use with furniture cam bolts (not included)
- Covers provide a finished look
- Constructed with durable beige-brown plastic
- Other colors available upon request



2021104373 2021104398

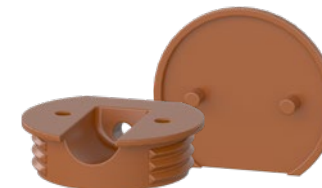

2021104414 2021104408

Part #	Name	↕ D	↕ H
2021104373	FIX1PIN	26 mm	8 mm
2021104398	FIX1PIN Cover	32,5 mm	--
2021104414	FIX2PIN	26 mm	8 mm
2021104408	FIX2PIN Cover	32,5 mm	--

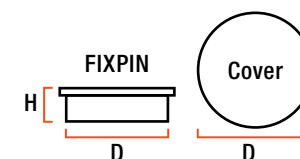

FURNITURE FITTING

- Plastic angle is ideal for stabilizing and connecting furniture components
- No-hassle installation and adjustment
- Double screw holes for secure screw-on application
- Constructed with durable beige-brown plastic



2021104348

Part #	↕ Height	↕ Width	↕ Depth
2021104348	20 mm	42 mm	20 mm

LIPPERT EMEA

Our journey

In 2016, Lippert began to focus its attention and resources in the European Caravanning Market acquiring some of the most successful companies in the industry. Headquartered in Tuscany, Italy, Lippert's manufacturing capabilities include entry door manufacturing and lamination, bed lifts, pop-up roofs for camper vans, slide-outs, table legs, TV brackets, bike carriers, entry steps, blinds, and flyscreens. In 2019, Lippert acquired the Italian Femto brand, which specializes in engineering parts, product design, prototype construction, and production equipment for a variety of industries. Lippert also expanded into The Netherlands by acquiring the Dutch Polyplastic group of entities, which specialize in producing window system solutions for the Caravanning and Equestrian industries and cooling door system solutions for the Retail industry. Most recently, Lippert acquired the German brand Schaudt, a manufacturer of power management, battery chargers, and electronic control systems. In 2023, Schaudt rebranded to Lippert.

As Lippert expanded into the European Caravanning Market, several strategic acquisitions were made in the Global Rail Industry, creating the Lippert Rail Division, manufacturing glass windows and interior furniture for trains. In the Rail Sector, Lippert's continued focus is on highly engineered products and extensive research of innovative solutions, offering these products to vehicle owners, operators, manufacturers and refurbishers, industry subcontractors, authorities, and organizations.

Lippert also made a substantial investment in the Global Marine Market with the acquisition of the Lewmar Limited group of entities, an industry leader in hardware, winches, hydraulics, windlasses, anchors, thrusters, steering systems, hatches, and portlights that suits every vessel from the smallest day fisher to largest mega-yacht.

Lippert acquisitions in EMEA



LIPPERT EMEA

Our locations

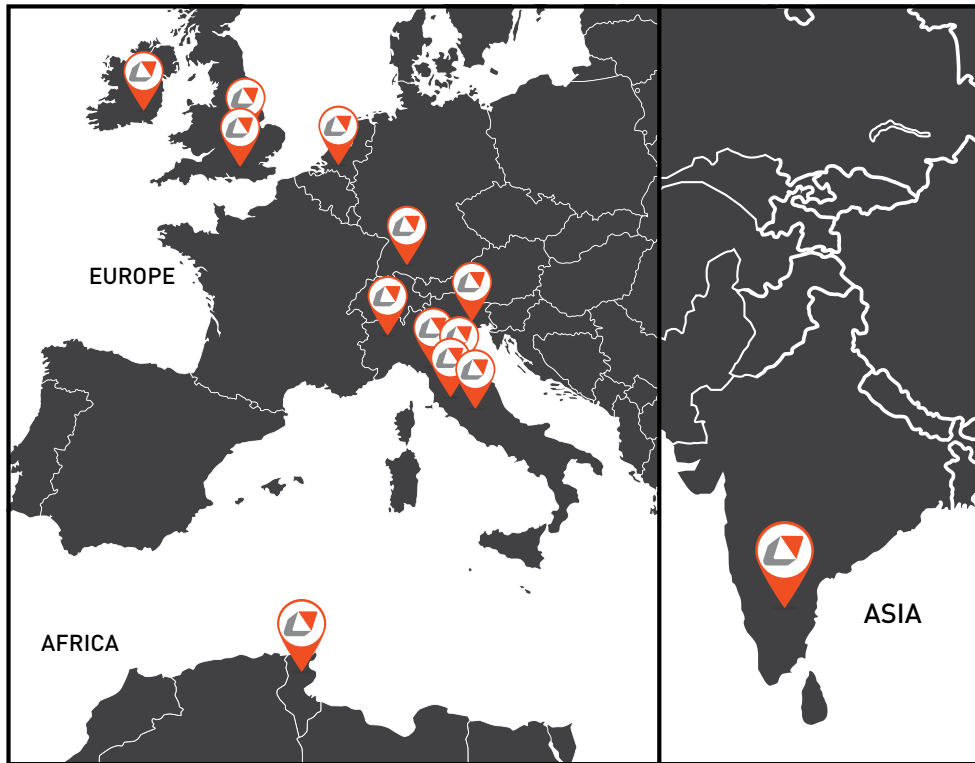

Caravanning

Germany
Markdorf

Italy

San Casciano
in val di Pesa
Pontedera
Torrita di Siena
Santa Maria di Sala
Monteriggioni

The Netherlands

Rotterdam
Tholen

Marine

Ireland
Templemore

United Kingdom

Catfield
Havant

Rail

India
Mysuru

Italy

Rignano sull'Arno
Monteriggioni
Terranova Bracciolini
Castronno

Tunisia

Djebel Oust



2019
(caravanning)



2019
(engineering parts)



2019
(rail)



2019
(marine)



2020
(caravanning)



2020
(retail)



2021
(caravanning)





**WHENEVER,
WHEREVER,
WE MAKE
YOUR
EXPERIENCE
BETTER.™**

 **LIPPERT®**





WHENEVER, WHEREVER, WE MAKE YOUR EXPERIENCE BETTER.™

View our locations and connect with us
lippertcomponents.eu/contact

All product names, logos, brands and other trademarks shown are the property of their respective trademark holders, and use of them does not imply any affiliation with or endorsement by them.

2024002518-RA